

BEFORE THE PUBLIC UTILITIES COMMISSION  
OF THE STATE OF HAWAII

----- In The Matter Of ----- )  
 )  
PUBLIC UTILITIES COMMISSION ) DOCKET NO. 2014-0183  
 )  
Instituting a Proceeding to Review the )  
Power Supply Improvement Plans for )  
Hawaiian Electric Company, Inc., Hawaii )  
Electric Light Company, Inc., and Maui )  
Electric Company, Limited. )  
\_\_\_\_\_ )

Hawaiian Electric Companies'  
PSIPs Update Report

Filed December 23, 2016

Book 3 of 4

## G. Energy Storage Systems

Energy storage systems are expected to play a fundamental role in achieving our 100% renewable energy goal. Energy storage systems provide the ability to time shift the output of variable renewable resources; in other words, absorbing and storing renewable energy when that generation exceeds customer demand, and releasing that energy later (typically several hours) when energy demand is high and renewable output is low. Energy storage systems can also provide important ancillary services to the system (for example, contingency reserves) and grid support where needed to ensure reliable service to customers.

Historically, pumped storage hydroelectric systems have been the only available energy storage technology for use in bulk power systems.<sup>1</sup> Battery energy storage systems (BESS) for utility applications are being currently offered commercially by a number of vendors. Market forecasts by various analysts project the capital cost of BESS, particularly lithium-ion batteries, to decline substantially over the next five to ten years. Other energy storage technologies (for example, flywheels) are emerging and can potentially compete with lithium-ion batteries in the near future. In the longer term, hydrogen energy storage might play a role at a bulk power level, but today exist only in small scale pilot projects.

Some electricity customers are beginning to install distributed energy storage systems (DESS) together with their rooftop solar PV installation. Integrating solar PV and electric vehicle charging is also emerging as a potential energy storage system that can manage and balance customer supply and demand, and potentially for the entire grid.

---

<sup>1</sup> Compressed air energy storage (CAES) has also been in commercial operation for many years, but to date there have been only a very small number of projects built due to the specific geology required and relatively high capital cost.

## G. Energy Storage Systems

### Energy Storage Technologies

The Companies anticipate including energy storage systems in our portfolio of resources required to achieve 100% renewable energy. Energy storage systems resources are expected to become more prevalent over time as costs decline and technology improves.

---

## ENERGY STORAGE TECHNOLOGIES

Various sizes of energy storage systems are commercially available ranging from one to two kilowatts of output to hundreds of megawatts, and with output durations of as much as six hours (or longer as with some pumped storage hydroelectricity projects).

For our December 2016 PSIP, we considered these energy storage systems: flywheels, pumped storage hydroelectric energy storage, lithium-ion energy storage systems, distributed energy storage systems (DESS), and hydrogen energy storage.

### Flywheels

Flywheels are rotating mechanical devices that store energy in the angular momentum of its rotating mass. A flywheel consists of a rotor (its rotating mass) attached to a motor (mounted on a very low friction bearing) and generator that spins at high speeds. To maintain the angular momentum of its rotating mass, a flywheel's motor acts like load and draws power from the grid, which enables the flywheel to absorb energy.

Flywheels provide inertia to a power system. During a grid event (such as a sudden loss of load), the inertia from the flywheel's motor drives its generator, creating replacement electricity that is injected back into the power system. The duration of the replacement electricity is relatively short (minutes at most). However, flywheels are useful for providing frequency response and can provide "ride-through" of contingency events (for example, the sudden loss of a large generator) that would otherwise result in significant frequency decay and possible loss of load. Typically the frequency response of a flywheel is faster than the response of a generator. Flywheels can provide the inertial response necessary to slow the rate of frequency decay, giving spinning reserve enough time to pick up load.

Flywheels have a minimum and maximum speed. The flywheel's actual speed indicates its "state of charge". The minimum speed represents a fully discharged state; the maximum speed represents a fully charged state.

While flywheels are expensive (high capital costs), they can charge and discharge hundreds of thousands of times over their useful life. Flywheel energy storage can be developed in two years or less (not including regulatory approvals and permitting lead-times). The round trip efficiency of a flywheel storage system is approximately 85%.

Flywheels have very little environmental impact. Modern metallurgy has produced flywheel technologies that are safe during operation. Flywheels can also be placed underground for additional safety.

The more than 400 flywheels currently placed in grid-scale situations have been operating for more than seven million hours.<sup>2</sup>

Beacon Power is the major flywheel manufacturer providing commercial grid-scale systems operating in the United States. Other flywheel manufacturers (such as Amber Kinetics) are working towards bringing their systems to market.

The rotor of a Beacon Power Smart Energy 25 flywheel spins between 8,000 rpm and 16,000 rpm. At 16,000 rpm, a single flywheel can deliver 30 kWh of extractable energy at a power level up to 265 kW for five minutes or as low as 170 kW for ten minutes (Figure G-1).

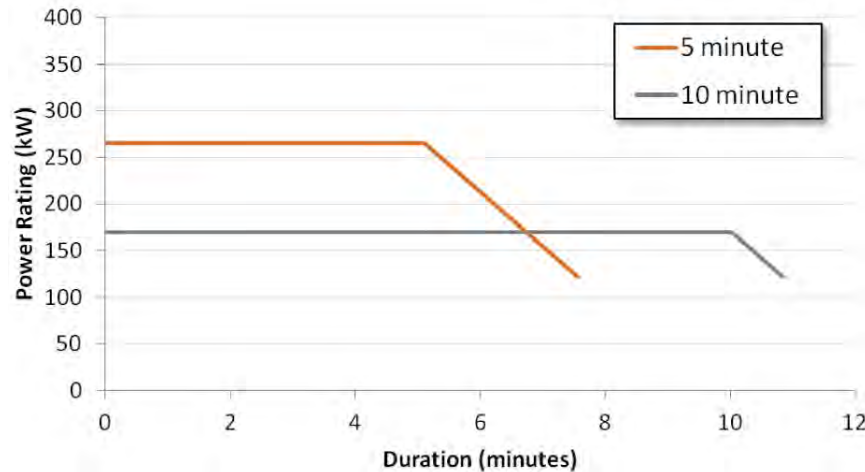

Figure G-1. Flywheel Extractable Energy Rates and Duration

The cyclic life capability of energy storage-based systems is of critical importance for performing frequency regulation. Beacon’s flywheel is designed for a minimum 20-year life, with virtually no maintenance required for the mechanical portion of the flywheel system over its lifetime.

Beacon’s experience to date in ISO New England involves 6,000 or more effective full charge and discharge cycles per year. The flywheel system is capable of over 175,000 full charge and discharge cycles at a constant full power charge and discharge rate, with no degradation in energy storage capacity over time.

<sup>2</sup> <http://beaconpower.com/operating-plants/>.

## G. Energy Storage Systems

### Energy Storage Technologies

A flywheel's mechanical efficiency for frequency response is over 97 percent; total system round-trip charge and discharge efficiency is 85 percent. Figure G-2 depicts a flywheel's superior capacity when compared with a lithium-ion battery.

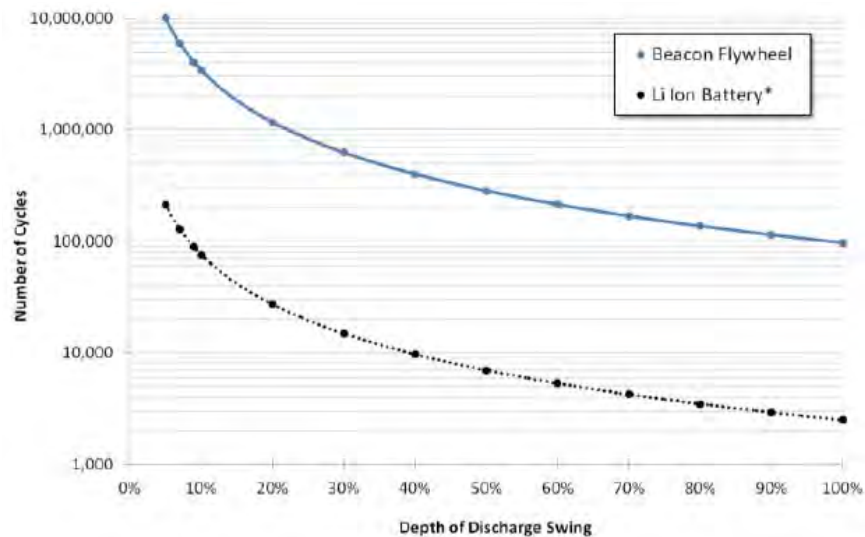

Figure G-2. Flywheel Cycle Life versus Lithium-Ion Battery

### Pumped Storage Hydroelectric Energy Storage

Pumped storage hydroelectric (PSH) energy storage is a mature technology that has been successfully implemented around the world in grid applications.

PSH stores energy as gravitational potential energy of water, pumped from a lower elevation reservoir to a higher elevation reservoir. When demand is low or renewable energy production is high, a reversible turbine-generator pumps water from the lower reservoir to the higher one. When energy is needed for the grid, water is released down into the lower reservoir through the turbine-generator, generating electricity. The distance between these two reservoirs—be they natural bodies of water or artificial reservoirs—must be high enough to generate power.

Pumped storage is the most widely used form of storage for large electrical grids. More than 120,000 MW of PSH has been installed around the world,<sup>3</sup> many of which exceed 1,000 MW per installation.<sup>4</sup> PSH installations are site-dependent, relatively expensive, and have long lead times for permitting and construction. According to the U.S. Department of Energy:

Pumped storage is a long-proven storage technology, however, the facilities are very expensive to build, may have controversial environmental impacts, have extensive permitting procedures, and require sites with specific topologic and/or geologic characteristics. As estimated in a report commissioned by EIA, the overnight cost to construct a pumped hydroelectric plant is about \$5,600/kW...<sup>5</sup>

While PSH has a relatively high capital cost, its useful life is 50 years or more. Pumped storage is very efficient, with round trip efficiencies in modern PSH plants exceeding 80%. Figure G-3 shows the typical layout of a PSH project.

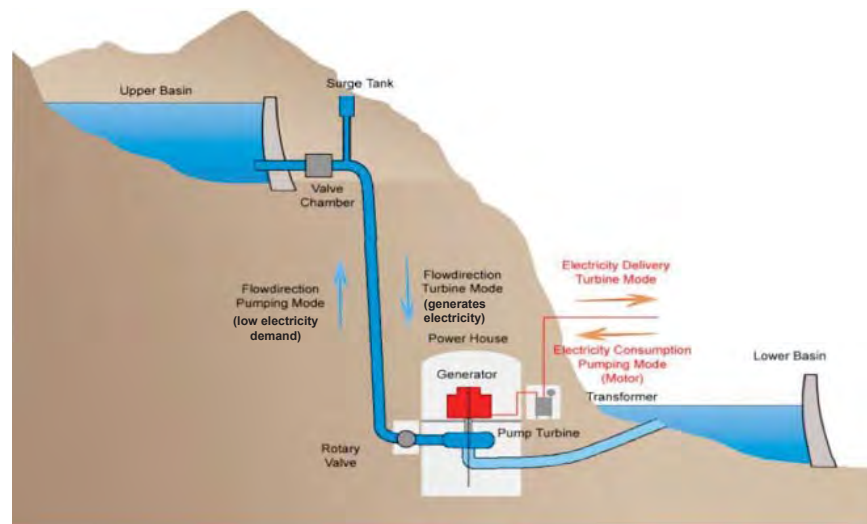

Figure G-3. Typical Pumped Storage Plant Arrangement<sup>6</sup>

PSH can provide peaking capacity and load shifting capabilities. While considered a quick-start resource, PSH takes a brief amount of time (about seven seconds) to start moving the water or to change direction through the turbine to produce electricity (its water column constant). These brief delays are limiting factors for single penstock systems.

<sup>3</sup> "Packing Some Power," *The Economist*. May 3, 2012, <http://www.economist.com/node/21548495?frsc=dg%7Ca> (citing EPRI as their source).

<sup>4</sup> [https://en.wikipedia.org/wiki/List\\_of\\_pumped-storage\\_hydroelectric\\_power\\_stations](https://en.wikipedia.org/wiki/List_of_pumped-storage_hydroelectric_power_stations). (This list is not complete. We are aware of projects not included in this list, and some smaller than the ones listed by this source).

<sup>5</sup> <http://www.eia.gov/todayinenergy/detail.cfm?id=6910>.

<sup>6</sup> Source: Alstom Power.

## G. Energy Storage Systems

### Energy Storage Technologies

An adjustable speed pump turbine provides more precise control, thus providing operating flexibility, which in turn allows PSH to provide ancillary services (such as frequency regulation, spinning reserve, and load following) while generating and pumping. This can increase operating efficiencies, improve dynamic behavior, and lower operating costs.

Unlike a battery (which already has charge) or a flywheel (that has angular momentum), starting a PSH charging cycle requires high levels of electric current to start the motors necessary to pump water to the higher elevation. For example, a 30 MW PSH system would require 37.5 MW of capacity to start and serve the pumping-mode motor load (assuming an 80% round-trip efficiency). In Hawai‘i’s relatively small power systems, the starting current of PSH motor loads could exceed the short circuit limits of the existing transmission system.

To put this in perspective, a 30 MW PSH system on the Hawai‘i Electric Light grid would require starting 37.5 MW of motor load (assuming an 80% round trip efficiency). Because the typical daily peak demand is about 150 MW, starting the PSH motor represents an instantaneous 25% increase in load. This could cause currents to exceed the short circuit limits of the transmission system, which, without mitigation, would result in a significant frequency disturbance.

Some mitigation measures include installing multiple penstocks with smaller turbines, or installing several small pumps and staggering their start-ups. Incorporating PSH into Hawai‘i’s electric systems may also require investment in transmission facilities.

Over the years, a number of PSH projects have been studied and proposed in Hawai‘i. Table G-1 through Table G-4 show the results of numerous PSH studies in our service areas. These studies shows a wide distribution of the per unit capital cost data, reflecting the site specific nature of PSH.

## O'ahu

Table G-1 summarizes the historical PSH projects studied on O'ahu. All costs are nominal dollars.

Site Designation	Study Year	Size (MW)	Hours of Storage	Estimated Capital Cost (\$M)	Estimated Capital Cost per kW
Kapa'a Quarry	No data	No data	No data	No data	No data
Ku Tree Reservoir	No data	No data	No data	No data	No data
Nu'uuanu Reservoir	No data	No data	No data	No data	No data
Koko Crater	1994	160.0	7.5	\$161	\$1,006
Ka'au Crater	1994	250.0	8.0	\$256	\$1,024
Kunia	2004	150.0	8.0	\$189	\$1,260
Mokuleia	2007	50.0	12.0	\$197	\$3,940
Hawaiian Cement	2008	7.0–74.0	8.0	No data	No data
Palehua	2014	200.0	6.0	\$650	\$3,250

Table G-1. Historical Studies of Pumped Storage Hydroelectric Projects on O'ahu

## Hawai'i Island

Table G-2 summarizes the historical PSH projects studied on Hawai'i Island. All costs are nominal dollars.

Site Designation	Study Year	Size (MW)	Hours of Storage	Estimated Capital Cost (\$M)	Estimated Capital Cost per kW
Pu'u Wa'awa'a	1995	30.0	6.0	\$71	\$2,367
Pu'u Anahulu	1995	30.0	6.0	\$71	\$2,367
Pu'u Enuhe	1995	30.0	6.0	\$61	\$2,033
Hawi	2004	10.0	5.0	\$39	\$3,900
Waimea	2004	2.3	12.0	\$17	\$7,391
Kaupulehu / Kukio	2006	50.0	5.0	\$239	\$4,780
Mauna Kea 15a	2016	56.4	5.0	\$228	\$4,046
Mauna Kea 5	2016	22.9	5.0	\$105	\$4,583
Mauna Kea 15a + 8c	2016	97.0	5.0	\$422	\$4,352
Kohala 12	2016	18.1	5.0	\$89	\$5,426
Kohala 8	2016	39.6	5.0	\$239	\$6,036

Table G-2. Historical Studies of Pumped Storage Hydroelectric Projects on Hawai'i Island



## G. Energy Storage Systems

### Energy Storage Technologies

#### Maui

Table G-3 summarizes the historical PSH projects studied on Maui. All costs are nominal dollars.

Site Designation	Study Year	Size (MW)	Hours of Storage	Estimated Capital Cost (\$M)	Estimated Capital Cost per kW
Ma'alaea	1995	30.0	6.0	\$83	\$2,767
Honokowai	1995	30.0	6.0	\$77	\$2,567
Kahoma	1995	30.0	6.0	\$104	\$3,467
Pu'u Makua	2006	50.0	12.0	\$169	\$3,380
Lahaina West	2007	14.7	5.0	\$62	\$4,218
Lahaina West	2007	6.9	3.6	\$39	\$5,652
Makawao	2007	31.2	5.0	\$220	\$7,051
Kihei	2008	50.0	9.0	\$315	\$6,300

Table G-3. Historical Studies of Pumped Storage Hydroelectric Projects on Maui

#### Moloka'i

Table G-4 summarizes the historical PSH projects studied on Moloka'i. All costs are nominal dollars.

Site Designation	Study Year	Size (MW)	Hours of Storage	Estimated Capital Cost (\$M)	Estimated Capital Cost per kW
East Moloka'i # 1	2007	3.0	5.0	\$15	\$5,000
East Moloka'i # 2	2007	1.0	5.0	\$7	\$7,000
West Moloka'i	2007	8.6	5.0	\$57	\$6,628

Table G-4. Historical Studies of Pumped Storage Hydroelectric Projects on Moloka'i

The vast majority of these studies are for PSH project less than 100 MW. Because the typical PSH installation in the United States is about 1,000 MW, there is limited data on the capital cost and performance for 100 MW PSH projects. Our research uncovered only a few instances of proposed (not constructed) comparably-sized PSH projects.

Based on limited data, we are using a capital cost estimate of \$3,500 per kW in 2016 dollars for a 30–50 MW grid-scale PSH project, evaluating it against other storage options. This is optimistic; the average capital cost of all past studies itemized in the above tables is \$4,050 per kW (not adjusted for inflation). The forecasted trend for PSH capital cost is flat in real terms, reflecting a mature technology.<sup>7</sup> These uncertain costs are in addition to the substantial permitting challenges any PSH project would face in Hawai'i.

<sup>7</sup> *E-storage: Shifting From Cost to Value Wind and Solar Applications*. World Energy Council. 2016. Table 6a: "Assumptions underpinning development of specific cumulated investment costs to 2030".

It bears noting that for the December 2016 PSIP update, we considered input from the Parties – in particular, Paniolo Power – regarding PSH. Paniolo Power did not submit a formal proposal about their interest in developing a PSH projects at Parker Ranch on Hawai‘i Island. They did, however, provide input assumptions for consideration in our PSIP modeling analysis. After careful consideration, together we determined that Paniolo’s input was essentially the same as ours, a key difference being Paniolo’s higher capital cost. Thus, the PSIP modeling used our lower capital cost PSH assumptions. (See “Input Incorporated into Our PSIP Update Report” in Appendix B: Party Commentary and Input for details on our joint discussions.)

Our portfolio optimization models considered PSH an available storage resource option. Toward that end, we will consider proposals for PSH projects that cost effectively and competitively meet specifically determined power system needs.

## Lithium-Ion Energy Storage Systems

Lithium-ion refers to a wide range of chemistries all involving the transfer of lithium-ions between electrodes during charge and discharge cycles of the battery.<sup>8</sup> Lithium-ion batteries are very flexible storage devices with high energy density, a fast charge rate, a fast discharge rate, and a low self-discharge rate, making lithium-ion batteries ideal for grid applications.<sup>9</sup>

Lithium-ion energy storage technologies have rapidly advanced to the point that they have recently become commercially available for grid-scale and distributed energy applications. These advances have been led by the development of advanced lithium-ion batteries for use in consumer electronics and automotive applications. According to a recent report from the Electric Power Research Institute (EPRI), battery energy storage “...is emerging as a potential technology solution for the utility industry because of a confluence of industry drivers related to both energy storage technology advancement as well as transformations in the electric power enterprise.”<sup>10</sup>

The EPRI report identifies several trends within the energy storage industry:

- Technological advances in energy storage with active cycling capabilities, combined with longer useful asset lives.
- Declining costs and performance improvements in lithium-ion battery technologies.
- A pipeline of innovative research and development related to more advanced storage technologies, which could lead to lower costs and longer durations of energy storage.

<sup>8</sup> Energy Storage Association. <http://energystorage.org/energy-storage/technologies/lithium-ion-li-ion-batteries>.

<sup>9</sup> *Lithium Ion Technical Handbook*. Gold Peak Industries (Taiwan), Ltd. [http://web.archive.org/web/20071007175038/http://www.gpbatteries.com/html/pdf/Li-ion\\_handbook.pdf](http://web.archive.org/web/20071007175038/http://www.gpbatteries.com/html/pdf/Li-ion_handbook.pdf).

<sup>10</sup> Electric Power Research Institute Inc. *Energy Storage Valuation Analysis: 2015: Objectives, Methodologies, Summary Results, and Research Directions*, Technical Update 3002006068, January 2016.

## G. Energy Storage Systems

### Energy Storage Technologies

Capital costs for lithium-ion batteries are declining,<sup>11</sup> particularly as the use of lithium-ion for electric vehicle batteries rises. Even with their current commercial status, the expectations are for lithium-ion battery performance to improve, and for costs to continue to drop.

Grid-scale lithium-ion batteries installations can be easily scaled in size; have relatively short lead times for procurement, engineering, and installation; and have ultimate flexibility for permitting and siting them at available real estate or existing utility plant sites. Lithium-ion energy storage systems can be configured for a number of different applications at various voltage levels. This flexibility makes lithium-ion energy storage systems an excellent candidate for providing non-transmission alternatives in constrained areas.

Lithium-ion batteries themselves have a useful life through 4,000 to 5,000 normal charge-discharge cycles. More frequent use of the full charge-discharge capabilities of lithium-ion would shorten the life. Lithium-ion battery energy storage can be developed in two years or less, not counting regulatory approval lead-times. The typical efficiency of lithium-ion batteries is 80%-90%, depending on the application.

The use of lithium-ion batteries is largely being driven today by automotive and consumer electronic applications. Disposal of these kinds of lithium-ion batteries presents a challenge. Indeed, the increasing number of hybrid and electric vehicles (EVs) entering the market creates potential battery issues at an EV's end of life or when battery replacement is necessary. Several strategies have emerged for dealing with these "used" EV and hybrid lithium-ion batteries including recycling, remanufacturing, and reuse.

**Recycling.** Very few recycling facilities currently exist in the world, mainly because the cost to recycle a battery is high while commodity prices for the materials recovered from the recycling process are low.

**Remanufacturing for Vehicles.** Tesla has taken this approach, recycling their vehicle batteries in-house and reusing certain components for new batteries.

**Reuse for Stationary Energy Storage.** Lithium-ion batteries in EVs retain about 70% of their useful capacity at the end of their automotive service life.<sup>12</sup> Repurposed EV batteries are most useful for applications that require relatively light duty cycles (that is, daily charge and discharge cycles for load shifting and peaking applications). In these uses, their expected life is estimated to be about ten years. The primary cost associated with repurposing an EV lithium-ion battery is technical labor, so the cost is relatively low. Bloomberg reports that the cost of repurposed EV batteries for stationary storage applications might be on the order of half of the cost of new batteries (excluding the

<sup>11</sup> See for example: <http://rameznaam.com/2013/09/25/energy-storage-gets-exponentially-cheaper-too/>.

<sup>12</sup> <http://www.nrel.gov/transportation/energystorage/use-analysis.html>.

balance of plant components of a stationary energy storage application). Bloomberg predicts that by 2025, about one-third of all EV batteries will be repurposed for stationary storage.<sup>13</sup> Not all batteries are suitable for repurposing; advanced vehicle diagnostics can provide information about the state of the battery and its suitability for being repurposed as stationary energy storage. Nissan is pursuing the repurposing and refurbishing of batteries for stationary storage markets.

A number of the Parties commented about the technology status of lithium-ion batteries. As an example, in its comments filed on January 15, 2016 in Docket 2014-0183, Paniolo Power states:

...while larger battery systems are starting to be built, batteries used for long duration, grid-scale applications must still be considered in the development phase... Battery technologies for long duration storage should be considered still under development as they are simultaneously attempting to improve the chemical compositions, storage capacity, operating life, disposal issues, and costs of batteries.<sup>14</sup>

However, our findings, based on current market conditions, show that lithium-ion battery technology has made substantial advances in cost and performance. Several vendors have reached a level of maturity and capitalization that they can offer performance guarantees on grid-scale lithium-ion battery systems. Kauai Island Utility Cooperative (KIUC) has contracted to purchase power from a solar PV project that incorporates a four-hour lithium-ion energy storage system. We find this indicates that long-duration storage technology has reached a level of technology maturity to support commercial applications.

## Distributed Energy Storage Systems (DESS)

A distributed energy storage system (DESS) – mostly employing lithium-ion battery technology – is once located on a customer’s property that helps control the customer’s DG-PV generation. High penetrations of this DG-PV generation create many challenges: uncertain amounts of generation; inadequate dispatching or scheduling control; and distribution, and possibly transmission, systems capacity excesses. DESS batteries, optimally located and combined with a modernized grid, can mitigate many of these DG-PV challenges.

The load shifting capabilities from DESS can reduce the impacts to DG-PV generation and to distribution and transmission systems. DESS can also provide backup power, voltage correction, and the ability for a customer to participate in demand response programs.

<sup>13</sup> <http://www.energy-storage.news/news/repurposed-ev-batteries-could-rival-first-life-storage-systems-bnef>.

<sup>14</sup> Docket 2014-0183, Comments of Paniolo Power, January 15, 2016, pp 23–24.

## G. Energy Storage Systems

### Energy Storage Technologies

Long-term benefits include improved system control and reliability of essentially uncontrolled DG-PV, and improved system reliability. DESS can also help reduce peak loads, help regulate voltage and frequency, and allow more time for service restoration during scheduled or accidental power interruptions.

DESS typically last for 15 years or more, are capable of over 3,000 charge-discharge cycles, have a net round trip efficiencies approaching 90%, and generally cost between 15¢–25¢ per kWh. While DESS batteries are improving, full power output durations for DESS are currently only about two hours.<sup>15</sup>

## Hydrogen Energy Storage

Hydrogen is a versatile energy storage carrier, with high energy density, that holds significant promise for stationary, portable, and transport applications. Hydrogen could be used to “de-carbonize” applications that rely on natural gas.

In electricity applications, hydrogen can be produced through electrolysis with “excess” variable renewable energy (for example, energy available for production by wind and solar resources at times when the net system demand for electricity is low). Hydrogen can be stored under pressure in storage vessels or underground caverns. The stored hydrogen is then used in fuel cells or to produce electricity, thus providing a means of load shifting in grids with high penetrations of variable renewable resources.<sup>16</sup>

Figure G-4 depicts a simplified schematic of a hydrogen energy storage system.

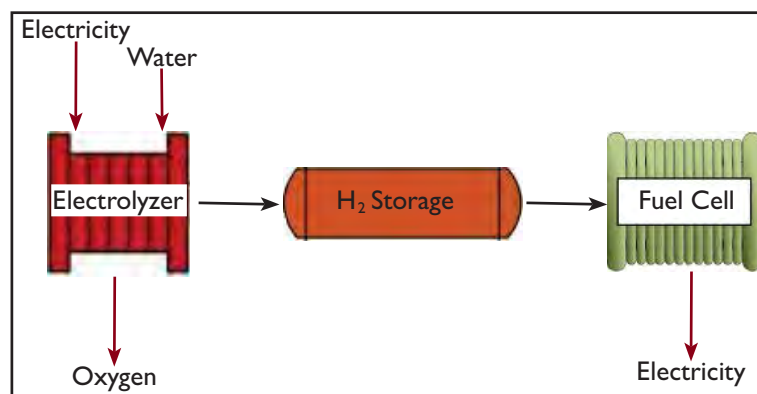

Figure G-4. Hydrogen Energy Storage System Schematic

While Europe has a relatively robust commercial supply chain for hydrogen production and storage for industrial uses,<sup>17</sup> hydrogen storage technology for electricity is still in the

<sup>15</sup> August 15, 2016 conference call between the Company and SunPower representatives.

<sup>16</sup> *Program on Technology Innovation: Hydrogen Energy Systems Development in Europe*, Technical Update 3002007274. Electric Power Research Institute, January 2016.

<sup>17</sup> *Ibid.*

research and development phase. In the United States, demonstration projects have been constructed that integrate wind turbines and solar PV with electrolyzer systems to produce hydrogen. In addition, a significant challenge towards commercializing hydrogen energy storage appears to be the ability to scale to larger sizes.<sup>18</sup> According to NREL: "... hydrogen can play an important role in transforming our energy future if hydrogen storage technologies are improved."<sup>19</sup>

Current conditions indicate that the availability of grid-scale commercial hydrogen storage systems is limited and thus not a viable near-term technology. Some of the Parties stated that we should consider hydrogen energy storage systems, however, none provided information as to this rationale. Further, the Parties did not submit any information or set of assumptions (including capital cost forecasts, operating cost forecasts, and round-trip efficiencies) that would allow us to model hydrogen energy storage systems.

Hydrogen energy storage systems hold great promise, and could very well substitute for the other energy storage technologies (such as flywheels, PSH, and lithium-ion batteries) considered for our PSIP, should they be more cost effective after attaining technological maturity.

We will continue to monitor developments in this technology, and as appropriate, include hydrogen energy storage in future power supply plan updates.

---

## ENERGY STORAGE APPLICATIONS

Energy storage resources can be used to provide a number of services.

*Inertia:* Arrests frequency decline and stabilize the system using the ability of a machine with rotating mass. Batteries cannot provide inertia. Flywheels can provide inertia.

*Frequency Response:* Reduces the rate of change of frequency (RoCoF) to help stabilize system frequency immediately following a sudden loss of generation or load.

*Regulation:* Meets short-term changes in load and supply within seconds and minutes, because of solar fluctuations or the variable wind resources.

*Replacement Reserves:* Restores the above faster services after they are deployed to be ready for the next event or further changes in net load. Replacement Reserves are deployed in the minutes-to-hours timeframe and provide capacity to restore system

---

<sup>18</sup> <http://www.renewableenergyworld.com/articles/2014/07/hydrogen-energy-storage-a-new-solution-to-the-renewable-energy-intermittency-problem.html>.

<sup>19</sup> [http://www.nrel.gov/hydrogen/proj\\_storage.html](http://www.nrel.gov/hydrogen/proj_storage.html).

## G. Energy Storage Systems

### Energy Storage Applications

frequency to 60 Hz following a contingency event or supplement Regulating Reserves because of forecast errors.

*Load Shifting:* stores energy for use at a later time to serve demand.

Table G-5 summarizes the applications, uses, duty cycles, technologies, and sizes of energy storage systems.

Application	Duration	Storage Duty Cycles	Depth of Discharge	Energy Storage	Sizes Available to Planners (MW)
Inertia	Seconds	5,000 per year	Deep: up to 100%	Flywheels	10
Frequency Response	Up to 30 minutes	~10 per year	Deep: up to 100%	Lithium-Ion BESS	1, 5, 10, 20, 50, 100
Regulation	Up to 30 minutes	~15,000 per year	Shallow: 20% to 50%	Lithium-Ion BESS	1, 5, 10, 20, 50, 100
				PSH	30, 50
Load Shifting	1–8 hours	Daily	Deep: up to 100%	Lithium-Ion BESS	1, 5, 10, 20, 50, 100; 2 for grid support
				PSH	30, 50
				CSP with Storage	100

Table G-5. Updated PSIP Energy Storage Applications, Sizes, and Technologies

In theory, certain configurations of energy storage installations could potentially be used for more than its primary purpose. For instance, a load shifting battery can also provide some regulation service if required. A contingency battery could, in theory, provide some load shifting. A 20 MW, 30-minute hour battery (that is, 10 MWh) could provide 10 hours of load shifting storage if the output of the battery system is limited to 1 MW (1 MW x 10 hours = 10 MWh). The key to the “stacking” of such applications is to closely manage the battery’s charge and discharge cycling to maintain its useful life based on its designed application. Even in such cases, a higher capacity battery, or less reliable performance and availability of services, may be necessary when “stacking” applications.

## Cost Assumptions Related to Energy Storage

Figure G-5 depicts the underlying constant 2016 dollar assumptions for the capital costs associated with selected sizes, technologies, and applications for energy storage systems assumed in the 2016 updated PSIP. (Refer to Appendix J: Modeling Assumptions Data for the specific capital cost assumptions for energy storage resources.)

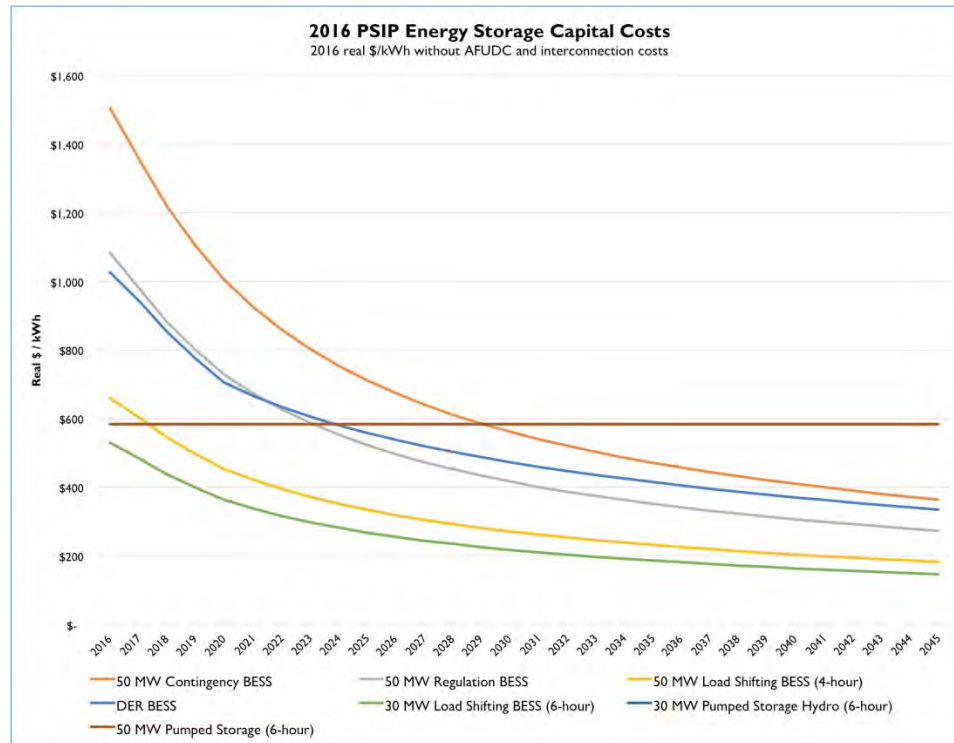

Figure G-5. 2016 Updated PSIP Energy Storage Capital Costs

The method for determining the capital and operating costs assumptions for energy storage systems was largely the same as for new grid-scale generating facilities. The primary source of data for current prices and forward curves was IHS Energy consultants. Prices were adjusted for Hawai‘i using RSMeans city indices. Prices were adjusted upwards by 4% to account for the Hawai‘i general excise tax.

Adjustments to BESS prices and costs were made based on the different applications. The application affects the “duty cycle” of the BESS, which in turn drives certain design parameters including the spacing of cells to better dissipate heat (longer duration storages requires more spacing, resulting in larger footprints) and air conditioning requirements. More frequent and deeper discharge of BESS requires replacement of battery cells more often in order to maintain output.<sup>20</sup>

### 5-5-5 Battery Initiative

Substantial investments in such initiatives are intended to make significant progress toward developing a breakthrough technology that significantly advances the power and reliability of energy storage systems while dramatically reducing costs. One such venture is the 5-5-5 battery initiative.

<sup>20</sup> Some vendors oversize the battery from the start, so that as the batteries degrade over time and the project’s output declines to the customer’s specified output requirements. Others provide warranty wraps where they replace cells as they degrade so that the desired output is maintained.



## G. Energy Storage Systems

### Energy Storage Applications

In 2013, the United States Department of Energy awarded the Joint Center for Energy Storage Research (JCESR), led by Argonne National Laboratory, with a \$120 million grant to address “the scientific and engineering research needed to advance the next generation of electrochemical energy storage for both transportation and the grid.”<sup>21</sup>

In a written statement before the Subcommittee on Energy Committee on Science, Space, and Technology of the United States House of Representatives, Director George Crabtree explained the vision and mission of JCESR through this grant:

JCESR's vision addresses the two largest energy sectors in the U.S.: transportation and the electricity grid, which together account for two-thirds of our energy use. Our vision is aggressively transformative: to enable widespread penetration of electric vehicles that replace foreign oil with domestic electricity, reduce carbon emissions, and lower energy use; and to modernize the electricity grid by breaking the century-old constraint of matching instantaneous demand with instantaneous generation, enabling widespread deployment of clean and sustainable but variable wind and solar electricity while increasing reliability, flexibility and resilience. Both transformations can be achieved with a single disruptive breakthrough: high-performance, low-cost electricity storage, beyond today's commercial lithium-ion technology. JCESR's vision is to transform transportation and the grid with the next generation beyond lithium-ion electricity storage.

JCESR's mission goals are to provide two prototypes, one for transportation and one for the grid, which, when scaled to manufacturing, are capable of providing five times the energy density at one-fifth the cost of commercial batteries in January 2012 when our proposal was prepared, summarized by the shorthand expression “5-5-5”.<sup>22</sup>

JCESR implemented and continuously refines a new paradigm for battery research and development that integrated discovery science, battery design, research prototyping, and manufacturing collaboration in a single, highly interactive organization. JCESR expects this new paradigm to accelerate the pace of discovery and innovation and shorten the time from conceptualization to commercialization.

At the date of this statement, JCESR research has resulted in 26 invention disclosures with a dozen patent applications, and has selected and begun to converge four next-generation prototype concepts. In addition, JCESR is testing several candidate materials and batteries in half-cell and full cell prototypes.

<sup>21</sup> *Grid Energy Storage*, published by the U.S. Department of Energy, December 2013. p 42.

<sup>22</sup> Written Statement of George Crabtree, Director, Joint Center for Energy Storage Research (JCESR), Argonne National Laboratory, University of Illinois at Chicago. Before the Subcommittee on Energy Committee on Science, Space, and Technology United States House of Representatives; Hearing on: Department of Energy (DOE) Innovation Hubs, June 17, 2015. pp 1–2.

## H. Renewable Resource Options for O‘ahu

O‘ahu, Hawai‘i’s most populous island, could be challenged to meet the state’s 100% renewable generation goal using currently technology despite its relatively high resource potential for DG-PV. A main reason: O‘ahu has the lowest grid-scale wind and grid-scale solar PV resource potential relative to the demand for electricity because of the limited land area available for development.

Although other renewable resources may emerge, we have identified the following existing and emerging renewable energy resources that could attain 100% renewable generation on O‘ahu:

- DG-PV as a component of DER
- Grid-scale solar PV and grid-scale (onshore) wind
- Offshore floating platform wind
- Interisland transmission connected to off-island renewable resources
- Hydrokinetic (ocean) energy

Each resource has the *potential* for generating bulk quantities of energy to meet the renewable generation goal, however, each also faces impediments to realizing its full potential. Each option was discussed with the Parties during the development of this updated PSIP. A few of the Parties asserted that one or more of these options holds the answer to attain 100% renewable generation on O‘ahu. A deeper analysis reveals that the realities could be different for a number of reasons.

All of these renewable resource options are discussed here in detail: their potential, their technical capabilities, their potential cost, and their current status, and their associated risk factors.

---

## MEETING HAWAI‘I’S RENEWABLE ENERGY GOALS

Our April 2016 updated PSIP incorporated a number of changes to the input assumptions. The most notable new assumptions include: the revision to Hawai‘i’s Renewable Portfolio Standards (RPS) upwards to 100% by December 31, 2045; and new, refined estimates of the remaining developable renewable resource potential on O‘ahu (defined to include existing commercially available zero-carbon renewable technologies).

### Grid-Scale Renewable Options

NREL, as requested by the Companies, conducted an independent detailed analytical study that estimated the technical renewable resource potential on O‘ahu, Maui, and Hawai‘i Island. Constructive discussions with the Parties resulted in NREL revising these resource potentials to reflect different criteria.

The NREL report is a “top-down” analysis of resource potentials, based on publicly available wind and solar data bases, and a variety of “exclusions” of areas where development is known to not be possible (for example, urban areas, parks, and highly sloped areas). The NREL resource potential results provide an important data point for wind and solar PV resource potentials on O‘ahu. Any such top-down estimate is likely to *overstate* the actual resource potential, since a top-down analysis does not investigate site specific circumstances for every possible site. In addition to land areas with slopes less than 10% for which PV is already an approved use, NREL’s grid-scale solar potential for O‘ahu assumes that all Agricultural B and C class land is used for solar. Because Agricultural B and C lands currently have area restrictions associated with PV use, *the developable resource potential could be substantially less than the NREL estimates.*

Two months after NREL submitted its revised report, an Ulupono representative (Dr. Matthias Fripp) suggested that the technical resource potential for grid-scale solar PV and grid-scale wind was substantially more than those presented in the NREL report. Subsequently, we also included these higher potential amounts in our analysis.

The NREL study and Ulupono’s assertion are not intended to justify a definitive course of action. Rather, these study estimates inform planners and policy makers as to the availability and amount of renewable energy resources, based on existing technologies and land availability. Given O‘ahu’s energy demand, additional renewable energy resources will likely be needed beyond what is available from the high DG-PV potential and grid-scale wind and solar potentials identified by NREL. This risk is substantial enough that policy makers, project developers, and regulators would be prudent to consider today how additional resources *might* be developed should that turn out to be

the best option to achieve the state’s energy goals. These options include offshore wind, hydrokinetic technologies, interisland transmission cables, or other new technologies – all of which face their own challenges for implementation.

### Offshore Energy Alternatives

Offshore floating platform wind technology is currently in the pilot project phase. The very first offshore wind facility ever developed in the United States, the Block Island Wind Project off the coast of Rhode Island, is only now achieving commercial operation (utilizing fixed bottom platforms). Other projects are also being developed. Clearly, the offshore wind power market in the United States is still in its early stages, but interest appears to be increasing. Success in deploying offshore wind resources to meet Hawai‘i’s renewable energy goals requires additional industry success for full-scale operation; *and* a sustained effort by federal and state agencies, project developers, community leaders, and the Companies to plan for the possible utilization of this resource.

Some of the Parties suggested that wave or tidal power could substantially contribute to Hawai‘i’s energy needs. The construction, development, and operational issues associated with these forms of hydrokinetic energy are very similar to those that apply to floating platform wind projects. The technical and commercial maturity of hydrokinetic energy, however, lags substantially behind that of offshore wind.

Interisland transmission cable technology is commercially ready, and has the credible potential of sharing renewable resources among all interconnected islands. Its feasibility for Hawai‘i, however, is uncertain because of the significant environmental, capital investment, cultural, social, permitting, and development challenges associated with realizing potential benefits.

---

### DISTRIBUTED ENERGY RESOURCES AND DG-PV

Distributed energy resources (DER) provide a core component of the potential renewable additions to the islands. DER can take many forms and encompass several approaches, including demand response, energy efficiency, electric vehicles, customer-owned generation, and customer-owned storage technologies.

#### The Market Potential of DG-PV

As we evaluate the landscape today, the most significant form of DER is distributed generation photovoltaics, or DG-PV: solar PV generation installed at the homes and businesses of Hawai‘i.

DG-PV plays an important role and is a critical component in achieving 100% renewable energy on O‘ahu. The implementation, timing, and adoption of residential and commercial solar generation, however, is not fully within our control, nor necessarily the Commission’s. Rather, it will be dictated in large part by the individual decisions of businesses and homeowners in response to products and service offerings.

The adoption of DG-PV is primarily driven by customer economics, which is then driven by two factors: the benefits of the DG-PV system to the customer (for example, avoided electricity purchases from the utility and compensation received for exports to the grid) and the capital and operating cost of the DG-PV system. We forecasted DG-PV adoption in two ways. First, for the market DG-PV forecast we assumed that compensation to DG-PV customers for exports is either zero (self-supply and SIA) or based on the cost of a grid-scale solar plant (future grid-export). Second, we forecasted a high DG-PV case based on the assumption that 100% of the single-family residential electricity sales would be offset by DG-PV by 2045 and roughly 20-25% of the total commercial sales would be offset by DG-PV in 2045. Customer economics were not addressed in developing the high DG-PV case. Achieving this higher level of DG-PV adoption will likely require mandates or significant additional customer incentives.

Table H-1 depicts the total projected installed capacities of the optimized DG-PV forecasts for the RPS milestone dates for the entire planning period of the updated PSIP.

Milestone Date	Market DG-PV Forecast	High DG-PV Forecast
December 31, 2015 <sup>1</sup>	471 MW	471 MW
December 31, 2020	856 MW	858 MW
December 31, 2030	1,169 MW	1,671 MW
December 31, 2040	1,517 MW	2,562 MW
December 31, 2045	1,697 MW	3,008 MW
Total Growth (2015–2045)	1,226 MW	2,537 MW
Growth Percent 2015–2045	360%	639%

Table H-1. DG-PV Forecasts Under Market and High Scenarios

In developing the 2016 updated PSIP, we have sought to estimate the likely rate of DG-PV adoption, ensuring any plan is robust enough to encompass higher or lower adoption rates while maintaining a path towards a 100% RPS. Our PSIP takes these sensitivities into account. We are committed to continuing to evaluate and optimize DG-PV under various adoption rates. DG-PV alone, though, cannot meet the 100% RPS target for Hawai‘i.

## The Technical Potential of DG-PV

The Company is exploring ways to develop estimates of the technical potential of DG-PV. Until recently, insufficient detailed data hampered our efforts. This situation, however, is beginning to change and, as a result, we are investigating several tools that may soon become available for this purpose.

### *Google’s Project Sunroof*

Google’s Project Sunroof<sup>2</sup> is one such promising application. Google’s Project Sunroof enables homeowners and solar installers to estimate the potential energy cost savings a residential electric customer can gain from a rooftop solar PV installation. Google recently expanded Project Sunroof to include a data explorer tool. The data explorer provides an estimate of total rooftop solar potential for a specified community, although coverage is not currently available in Hawai‘i. Project Sunroof combines the power of Google Maps with databases and other information.

<sup>1</sup> Does not include customer-side Feed-In Tariff (FIT) projects.

<sup>2</sup> (<https://www.google.com/get/sunroof#p=0>).

## H. Renewable Resource Options for O'ahu

Distributed Energy Resources and DG-PV

That information includes:<sup>3</sup>

- Imagery and three-dimensional modeling and shade calculations from Google.
- Weather data from the National Renewable Energy Laboratory (NREL).
- Utility electricity rates information from Clean Power Research.
- Solar pricing data from NREL's Open PV Project, California Solar Initiative, and NY-Sun Open NY PV data.
- Solar incentives data from relevant Clean Power Research, Federal, State, and local authorities as well as relevant utility websites.
- Solar Renewable Energy Credit (SREC) data from Bloomberg New Energy Finance, SRECTrade, and relevant state authorities.

Project Sunroof currently covers roughly 43 million buildings in portions of 42 states and in Washington D.C. Using three-dimensional models derived from aerial images, Project Sunroof estimates the amount of sun reaching a rooftop from various positions in the sky, the available space for rooftop solar panels, the amount of energy production given typical weather conditions for that area.

Project Sunroof processes aerial images to create a high-resolution 3D digital surface model. Solar energy can be separated into two types: direct normal irradiance (energy directly from the sun) and diffuse horizontal irradiance (energy from other parts of the sky). The entire surface of the earth receives both types. Project Sunroof considers both types under typical weather conditions throughout the year. The typical weather data includes cloud cover, wind & temperature data and is sourced from NREL. In other words, Project Sunroof estimates the solar potential for a given point on a roof, for a particular hour in a typical year, taking into account roof pitch and azimuth, shade, and typical weather data.

Project Sunroof's model identifies rooftop outlines from rough building sizes available in Google Maps, then uses Machine Learning and other heuristic information (such as green objects) to estimate the extent of each rooftop. For example, rooftop areas covered with tree branches are often ignored for the purposes of estimating solar potential. The model then counts segments of the roof with space for at least four contiguous 250 watt PV panels, and only considers the rooftops that have the potential with space for at least 2 kW of energy.

---

<sup>3</sup> Project Sunroof Technology: <https://www.google.com/get/sunroof/faq/>.

The technical potential, then, is the amount of energy that can be generated from panels that receive at least 75% of the solar energy received by ideally oriented and unshaded panels, irrespective of financial or societal constraints. This total technical potential can be segmented by cities, states, zip codes, and census tracts – and can be segmented into north-facing, east-facing, south-facing, west-facing, and flat roof segments as well as panel azimuth and tilt.

The Company discussed with Google the possibility of using the Project Sunroof databases to estimate potential individual distribution feeders. The Project Sunroof tool, however, cannot currently export Geographical Information Service (GIS)<sup>4</sup> layers that could be superimposed on our GIS maps of our distribution systems. Google stated that an automatic program interface (API)<sup>5</sup> might be developed that would enable accessing GIS layers in a way that utilities could estimate, and plan for, the solar potential by feeders. Until such an API is developed, it may be possible to arrange for the transfer of this data on an ad hoc basis. Regardless, GIS data for Hawai‘i is not currently available in Project Sunroof, although it’s scheduled to become available in the near future.

### *Mapdwell’s Solar System*

Solar System, an interactive online rooftop solar mapping tool developed by Mapdwell (a Massachusetts Institute of Technology spinoff) allows users to estimate the rooftop PV potential for almost every building in a given city. Solar System provides solar PV potential and a comprehensive cost-benefit analysis for both residential and commercial addresses. Solar System has been used to quantify rooftop PV potential in Portland, Oregon, San Francisco, New York City, and Boulder, Colorado.<sup>6</sup> Smithsonian Magazine called Solar System the “most accurate solar map in the United States” in 2013 and Denmark’s Sustainia think-tank selected Solar System as one of 2015’s top ten sustainable solutions world-wide.

Solar System uses three-dimensional elevation data to create a surface model of the sample terrain that accounts for the shape of building rooftops and structures, existing infrastructure, and tree foliage. Solar System also incorporates historical weather data for each location to account for varying weather conditions. This methodology calculates the amount of sunlight that strikes every point of a rooftop over the course of every hour of the year and yields highly granular and accurate estimates of generation potential.

Solar System defines a Solar Access Index (SAI), which is the solar PV electric yield of any given surface relative to the best possible yield within a given sample. SAI values

---

<sup>4</sup> GIS technology allows “layers” of information, based on geography, to be overlaid and compared. Examples of GIS layers include topography, streets, residential addresses, and asset locations.

<sup>5</sup> Typically, an API provides the protocols that allow two different software systems to interact. For example, an API could be developed by Google that would allow a GIS software application to access and utilize the data in the Project Sunroof application.

<sup>6</sup> <https://www.mapdwell.com/en/solar/buzz>.



## H. Renewable Resource Options for O'ahu

### Distributed Energy Resources and DG-PV

range from zero (that is, no solar PV potential) to 1.0, the maximum possible solar PV potential. Solar System screens each surface and eliminates those with SAIs below 0.5. It further identifies surfaces with SAIs of 0.75 or greater as "high PV potential." Using detailed assumptions regarding installation costs, electric rates, and local incentives, Solar System returns financial feasibility and environmental benefits of solar PV installations. Metrics provided to the user of Solar System include: cost to owner, monthly revenue, system size in kW, payback period, and carbon offset estimates.

Solar System can assess solar PV economic potential of individual home and business owners, and provide policymakers with area-wide assessments of distributed solar PV potential. Mapdwell also offers additional data services and GIS databases of solar potential.

We have spoken with Mapdwell; we are considering their Solar System as a potential tool for assessing rooftop PV potential across residential, commercial, and industrial buildings in our service areas.

---

## GRID-SCALE PV AND GRID-SCALE WIND POTENTIAL

The Companies retained NREL to determine the maximum resource potential for on-island grid-scale PV and grid-scale wind for O‘ahu, Maui, and Hawai‘i Island for our April 2016 PSIP. NREL delivered that report on March 17, 2016.

Based on Party input to the April 2016 PSIP, we asked NREL to conduct additional analysis regarding the grid-scale wind and solar resource potentials for O‘ahu. NREL’s expanded report, *Utility-Scale Onshore Wind, Utility-Scale PV, and CSP Potential Resource*, assessed these three resource potentials. (Since these utility-scale resources are owner agnostic, they are better characterized by the term “grid-scale”.) NREL delivered this additional study on July 21, 2016. (Appendix F: NREL Reports presents and discusses this updated resource potential study, and three others, in detail.)

At our request, NREL reran the grid-scale wind and grid-scale PV portion of this study for O‘ahu based on Stakeholder input. Here, the focus is on these O‘ahu results.

During stakeholder meetings, Dr. Matthias Fripp (representing Blue Planet and Ulupono) initiated a discussion with several Company representatives about the maximum renewable resource potential on O‘ahu. That discussion entailed the NREL resource potential study and used as input assumptions to our modeling analysis for that PSIP.

Dr. Fripp suggested that the NREL resource potential study’s screening assumptions were too conservative and should be changed as follows:

- Land slopes for potential grid-scale PV installations be increased to 10% because the 5% land slope is too conservative.
- Agricultural B and C class land be considered to assume that 100% of this land is available for PV development—even though special use permits are required for grid-scale PV installations exceeding 10% of a parcel or 20 acres, whichever is less.
- Land resolution be decreased from a four-kilometer square to a more granular one-kilometer square to potentially include projects that could be developed on smaller parcels of land.
- Wind project density of 3 MW per square kilometer was too low and should be raised to 8.8 MW per square kilometer.

We consulted with NREL about these revisions. NREL’s data showed that their wind project density is consistent with industry practices. The four- kilometer square data is publicly available and, as such, results in analysis that is both replicable and transparent. Thus, NREL did not change either of these factors (the third and fourth bullets above). At

## H. Renewable Resource Options for O‘ahu

### Grid-Scale PV and Grid-Scale Wind Potential

our request, NREL did conduct additional studies using land slope up to 10% and including 100% of Agricultural B and C land.

It’s important to note that we are using these NREL study results in our modeling analysis as the technical (or *theoretical*) maximum potentials. In actuality, much less than 100% of the resulting resource potential land is likely to be available for development.

Nonetheless, we have used NREL’s resource potentials in our modeling analysis; E3 has performed sensitivity analyses using Dr. Fripp’s resource potentials to understand the impact of these higher resource potentials.

Table H-2 depicts the difference between our initial input assumptions and those assumed by Ulupono as a result of their suggested changes. Note that these Ulupono amounts are projected, and not necessarily the results of the revised NREL resource potential study.

Resources (MW)	Hawaiian Electric (April 2016 PSIP)	Hawaiian Electric (December 2016 PSIP)	Ulupono (Dr. Fripp)
Onshore Grid-Scale PV	793	2,970	6,583
Market DG-PV Forecast	1,204	1,308	n/a
High DG-PV Forecast	1,592	2,101	n/a
Onshore DG-PV Potential	n/a	n/a	3,022
Onshore Grid-Scale Wind	162	162	2,680
Offshore Grid-Scale Wind	800	800	800

Table H-2. Renewable Energy Resource Potential for O‘ahu

The onshore grid-scale PV potential is based on fixed tilt units with a capacity factor of greater than 20% sited on up to a 10% land slope; 100% of Agricultural B and C class land included; and a 1.5 inverter loading ratio. The onshore grid-scale wind is based on wind speeds greater than 6.5 meters per second.

To support his suggestion, Dr. Fripp wrote an extensive email (on September 24, 2016 after the Third Stakeholder Meeting) describing revised results of grid-scale solar PV potential (in an email on October 18, 2016) and gave a presentation (at the Fourth Stakeholder Meeting) explaining in detail the rationale for altering NREL’s resource potential study. He discussed his research about the technical (*theoretical*) potential for rooftop DG-PV, grid-scale wind, and grid-scale solar PV on O‘ahu. Dr. Fripp also cited the report entitled *Development of SWITCH-Hawai‘i Model: Loads and Renewable Resources* published almost two years earlier in December 2014 by the Electric Vehicle Transportation Center, the result of work in his university classroom.

Dr. Fripp’s estimated potential for rooftop PV is 3,022 MW (direct current) based on an assumption of 40% coverage of existing rooftops. This coverage assumption is based on

## H. Renewable Resource Options for O'ahu

### Grid-Scale PV and Grid-Scale Wind Potential

70% coverage of flat roofs (15% of total roofs) and 35% coverage of sloped roofs (85% of total roofs).

Dr. Fripp's estimated potential for grid-scale wind is estimated to be 2,680 MW. This is based on a density of 8.8 MW per square kilometer of land and no minimum capacity factors. The higher density is based on two factors: the Kahuku wind facility's density is 12.9 MW per square kilometer, and an NREL report estimates a high-end density of 5–8 MW per square kilometer.

This estimated grid-scale wind potential is broken out by annual capacity factor (Table H-3) and is based on 2007–2008 wind profiles.

Annual Capacity Factor	Available Wind (MW)
<12%	550
12% – 16%	558
16% – 18%	428
18% – 20%	125
20% – 22%	2
22% – 24%	198
24% – 26%	330
26% – 28%	48
28% – 30%	30
30% – 32%	50
32% – 34%	242
34% – 36%	119
<b>Total</b>	<b>2,680</b>

Table H-3. Technical Grid-Scale Wind Potential for O'ahu: Dr. Fripp Results

## H. Renewable Resource Options for O‘ahu

### Grid-Scale PV and Grid-Scale Wind Potential

Annual Capacity Factor	Available Fixed Tilt PV (MW)	Available Single-Axis Tracking PV (MW)
<18%	1	-
18% – 20%	455	0.5
20% – 22%	1,118	356
22% – 24%	4,129	262
24% – 26%	1,955	
26% – 28%	43	1,982
28% – 30%	-	2,138
30% – 32%	-	493
32% – 34%	-	34
<b>Total</b>	<b>6,583</b>	<b>5,266</b>

Table H-4. Technical Grid-Scale PV Potential for O‘ahu: 20% Land Slope: Dr. Fripp Results

Dr. Fripp’s estimates of grid-scale PV potential are based on a 10% slope exclusion and development densities of 6 acres per MW(AC) for fixed-tilt PV and 7.5 acres per MW(AC) for single-axis tracking PV. For comparison purposes, the NREL grid-scale PV potential is based on a development density of 8.7 acres per MW(AC). Dr. Fripp’s analysis concludes that the technical grid-scale single-axis tracking PV potential is approximately 6,583 MW, while the technical grid-scale fixed tilt PV potential is approximately 5,266 MW. Both of these technical PV potentials are based on use of the same available land, thus their estimates are mutually exclusive: analysis should be based on 100% of single-axis tracking PV, 100% fixed tilt PV, or a mix of both totaling 100% use of available land.

Note first that the grid-scale wind, grid-scale single-axis tracking PV, and grid-scale fixed tilt PV are estimates of technical resource potentials, and second that they are estimates. In other words, these amounts represent technical maximum resource potentials. Many factors can combine to reduce these resource potentials: land access and ownership, community concerns, permitting issues, transmission infrastructure and access to transmission lines, cost, and the economic feasibility of building projects in the marginal (low-capacity factor) sites identified by both NREL and Ulupono. Conversely, there are factors that may increase the estimates (such as technical advances in PV module efficiencies).

## Geographical Resource Potential Representations

While the technical resource potential of grid-scale PV and grid-scale wind on O‘ahu is a significant amount of nameplate capacity, a closer look reveals a more moderated reality of the resource potential that can actually be harnessed.

### Grid-Scale PV Potential

Figure H-1 and Figure H-2 depict the potential grid-scale PV sites on O‘ahu as determined by the NREL resource potential study. These earth-map representations correspond with the O‘ahu maps in Figure F-19 through Figure F-22 in Appendix F: NREL Reports.

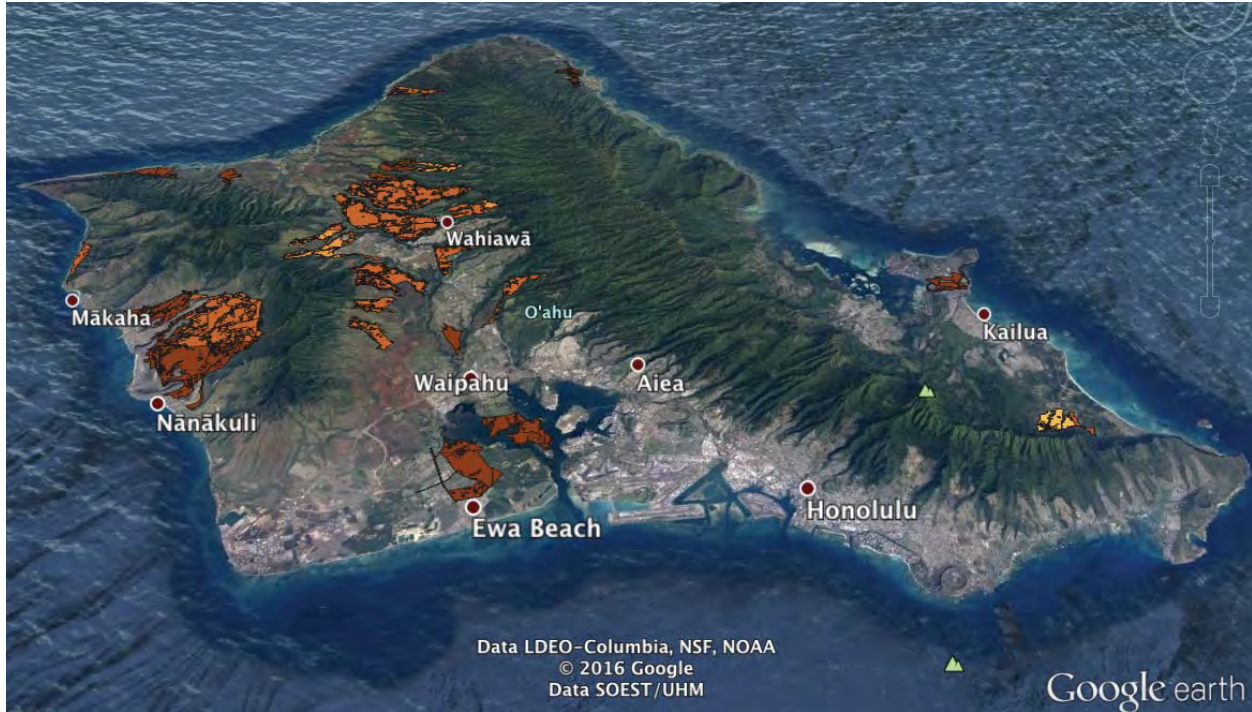

Figure H-1. Grid-Scale PV Development Potential for O‘ahu (NREL detail)

The map shows four areas of PV annual capacity factor percentages – the larger the percentage, the greater the grid-scale PV potential. These four color-coded areas are listed in Table H-5.

Color	PV Class	PV Potential (MW)
Dark Orange	20+	414–1,053
Orange	18–20	1,338–2,756
Light Orange	16–18	1,338–2,923
Yellow	14–16	1,338–2,970

Table H-5. O‘ahu Grid-Scale PV Class Designations

Refer to Table F-8: Grid-Scale Solar PV Potential for O‘ahu (MWac) on page F-6 in Appendix F: NREL Reports for a detailed breakdown of how these capacity factors translate into MW potential.

## H. Renewable Resource Options for O‘ahu

### Grid-Scale PV and Grid-Scale Wind Potential

At the island-wide size depicted in Figure H-1, though, it is difficult to see the detail of the grid-scale PV potential, and the numerous noncontiguous and small areas that comprise the overall resource potential.

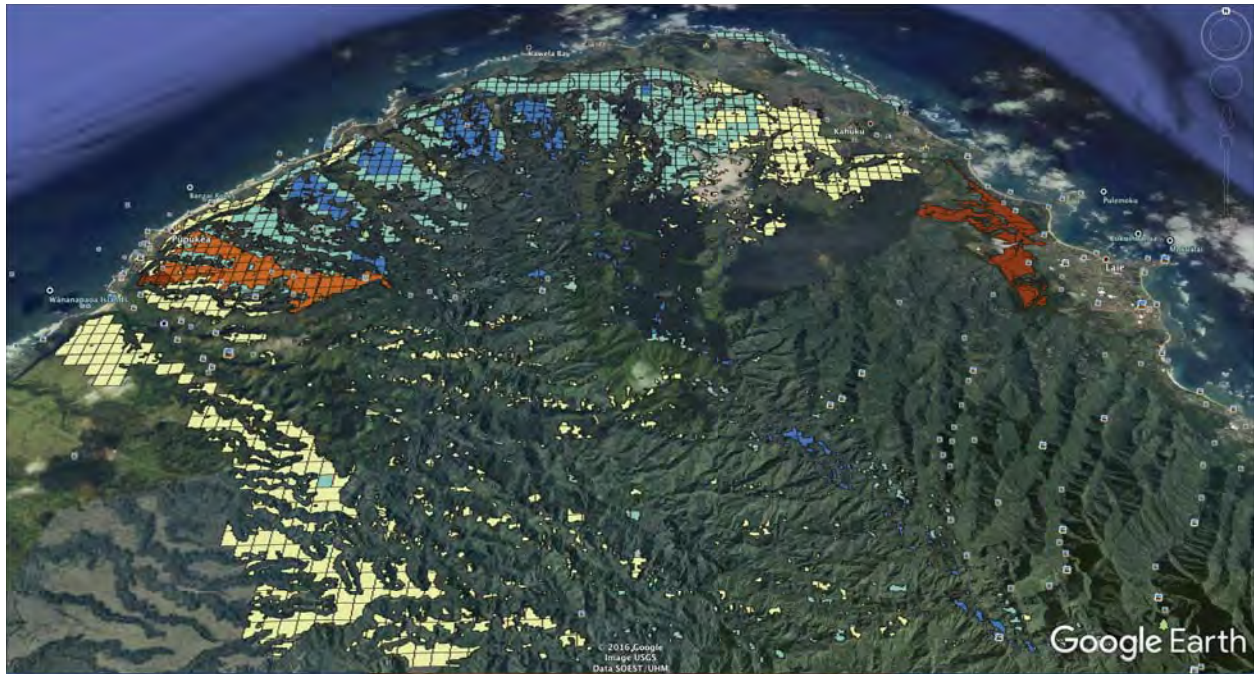

Figure H-2. Grid-Scale PV Development Potential for O‘ahu (NREL North Shore detail)

From the perspective of Figure H-2, the four-kilometer square segments are clearly shown. There are a number of clustered segments that show the potential for large grid-scale PV installations. What is also clear are the numerous small grid-scale PV potential sites scattered throughout the center of the photo. Virtually all of these areas are situated on the foothills of the Ko‘olau mountain range and the flatter sections of the mountain range’s summit. This depiction is typical of the remainder of the island. Neither the feasibility of developing these small sites, nor the costs for installation, maintenance, and transmission from these sites, has been researched or evaluated.

The largest current grid-scale PV installation in Hawai‘i is Waianae Solar. Located on the leeward side of O‘ahu, mauka of Kamaile Academy and the Uluwehi community, the facility covers 198 acres; its installed solar modules generate 27.6 MWac of power.

Figure H-3 and Figure H-4 help gain a perspective, from two different viewpoints, of this sizeable grid-scale PV installation.



Figure H-3. Waianae Grid-Scale Solar Facility on O'ahu (broad under-construction viewpoint)



Figure H-4. Waianae Grid-Scale Solar Facility on O'ahu (close-up detail)



## H. Renewable Resource Options for O'ahu

### Grid-Scale PV and Grid-Scale Wind Potential

Figure H-5 and Figure H-6 show a geographical comparison of the NREL results for grid-scale solar PV potential with those of Ulupono representative, Dr. Fripp.



Figure H-5. Potential O'ahu Grid-Scale PV Sites: NREL Revised Results

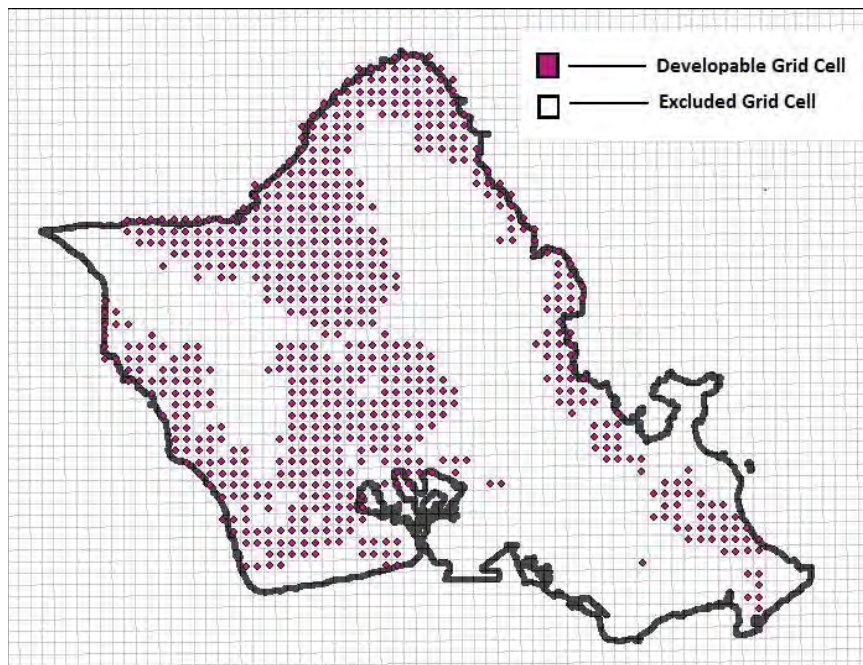

Figure H-6. Potential O'ahu Grid-Scale PV Sites: Dr. Fripp Results

### Grid-Scale Wind Potential

Figure H-7 depicts the potential grid-scale wind sites on O'ahu as determined by the NREL resource potential study. This earth-map representation corresponds with the O'ahu map in Figure F-10: Grid-Scale Onshore Wind Development Potential for O'ahu on page F-19 in Appendix F: NREL Reports.



Figure H-7. Grid-Scale Wind Development Potential for O'ahu (NREL detail)

The map shows three areas of mean wind speeds at 80 meters – the higher the speed, the greater the grid-scale wind potential. These three color-coded areas are listed in Table H-6.

Color	Speed Class	Wind Potential (MW)
Blue	8.5+	16–19
Blue-Green	7.5–8.5	68–81
Yellow	6.5–7.5	162–174

Table H-6. O'ahu Grid-Scale Wind Speed Class Designations

Refer to Table F-5. Grid-Scale Onshore Wind Potential for O'ahu (MWac) on page F-5 of Appendix F: NREL Reports for a detailed breakdown of how these capacity factors translate into MW potential.

The same issue of perspective holds true for the island-wide map for grid-scale wind potential depicted in Figure H-7 as for the grid-scale PV potential depicted in Figure H-1.

## H. Renewable Resource Options for O‘ahu

### Grid-Scale PV and Grid-Scale Wind Potential

The overall resource potential comprises several concentrated areas together with numerous noncontiguous and small areas.

The North Shore of O‘ahu shows the greatest potential for grid-scale wind, with virtually all the remaining sites scattered across the island in small segments.



Figure H-8. Grid-Scale Wind Development Potential for O‘ahu (NREL North Shore detail)

From the perspective of Figure H-8, the four-kilometer square segments are clearly shown. The clustered segments that are conducive to large grid-scale wind installations almost exactly match the segments that are conducive to large grid-scale PV installations (see Figure H-2 to compare). In the end, to achieve the maximum generation, these sites would have to be developed for both PV and wind.

Notice also that, as with grid-scale PV, numerous small grid-scale wind potential sites are situated on the foothills of the Ko‘olau mountain range and the flatter sections of the mountain range’s summit. This depiction is typical of the remainder of the island. The feasibility of developing these small sites, or the costs for installation, maintenance, transmission and interconnection from these sites, have not been researched or evaluated.

Figure H-9 (a more definitive representation of the grid-scale wind depicted in Figure H-7) and Figure H-10 show a geographical comparison of the NREL results for grid-scale wind potential with those of Ulupono representative, Dr. Fripp.



Figure H-9. Potential O'ahu Grid-Scale Wind Sites: NREL Revised Results

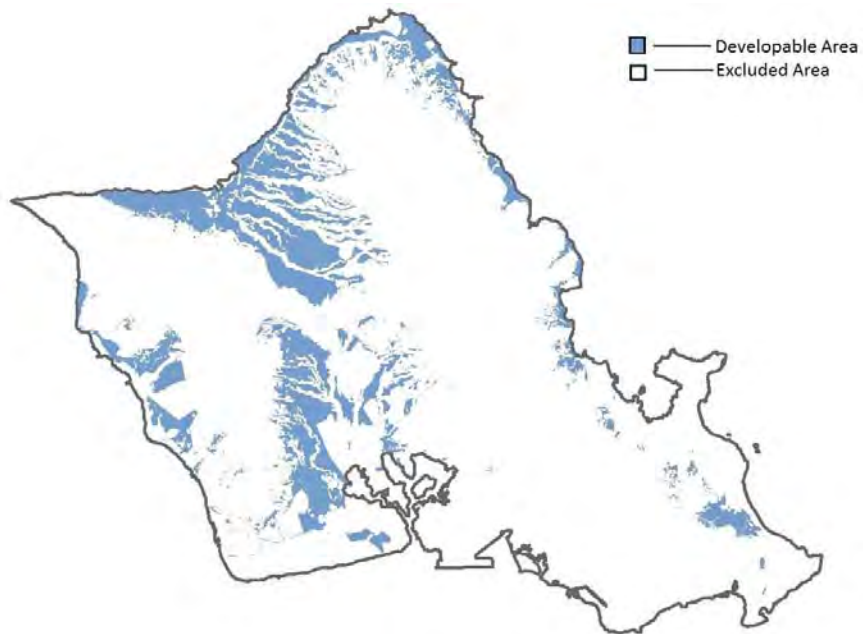

Figure H-10. Potential O'ahu Grid-Scale Wind Sites: Dr. Fripp Results

## H. Renewable Resource Options for O‘ahu

### Grid-Scale PV and Grid-Scale Wind Potential

#### In the Final Analysis

A thorough review of Figure H-1 through Figure H-10 indicates the substantial amount of land – under either analysis – necessary to realize these potential resources on O‘ahu. To realize the maximum grid-scale solar PV potential postulated by Dr. Fripp’s analysis would require that approximately 10% of O‘ahu’s land area be covered with solar panels.

The analyses conducted by NREL and Dr. Fripp represent the maximum technical potential for grid-scale solar PV and grid-scale wind on O‘ahu. These amounts, however, represent the *technical* developable potential, not necessarily *actual* developable potential as neither considers the reality of being able to develop any identified land parcel.

These developmental challenges include, but are not limited to:

- Community acceptance of a project at a given site, including its visual impacts.
- Competing land uses (for example, agricultural or other permissible uses).
- The actual ability to obtain Special Use Permits for Agricultural B and Agricultural C class lands beyond the 10% parcel or 20 acre threshold.
- Environmental issues and considerations.
- Geotechnical conditions associated with any particular parcel.
- Lack of developer interest in parcels that could accommodate only smaller project sizes.
- Lack of developer interest in parcels that could accommodate projects with relatively low capacity factors.
- Inaccessible or prohibitive development costs for remote parcels.
- Access, potential difficulty, and times associated with building new transmission facilities to access projects at remote parcels.
- Privately-held parcels might not be for sale or available for development.
- Potential higher capital costs for developing land with a greater than 5% slope.

All of these limiting factors will affect the ability to realize these resource potentials; all are *outside* the control of the Companies. Outside of these limiting factors, the State and local communities must also develop policies that will facilitate developing a substantial portion of these resource potential land parcels.

---

## OFFSHORE FLOATING PLATFORM WIND ENERGY

Our April 2016 PSIP identified offshore floating platform wind energy as a potential resource option for meeting future renewable energy requirements. The proposed offshore wind project would be installed on floating platforms in 700–1,000 meter deep water off of the coast of O‘ahu. This section assesses the viability of such a successful offshore floating platform wind project.

### Overview

Offshore wind energy installed on floating platforms has the potential to drive considerable growth in wind generation around the world. Whereas fixed bottom wind generation is generally limited to shallow waters, floating platform wind projects offer the potential to unlock considerable amount of wind energy potential along coastlines where the waters are too deep to accommodate fixed bottom installations (for example, west coast of the U.S. and Hawai‘i). Further, the ability to site wind in deeper waters, allows wind generation to be installed “below the horizon” where they are only partially visible or totally invisible from the shoreline, thus minimizing siting objections common with onshore wind development.

#### *Potential for Lower Priced Energy*

Floating platforms also have the potential to achieve lower cost than fixed bottom technologies due to the ability to assemble the fixed platforms in port and tow them into place at the site. This avoids deployment of expensive-to-charter heavy lifting vessels during the initial installation of the wind projects and in events where major repairs are required. As of today, however, floating platforms are quite a bit more expensive than fixed platform wind installations. Declines in capital cost for floating platforms are a function of successful deployment of full-scale prototypes and subsequent multiple deployments with well-engineered components that can be mass produced and replicable installation techniques. Even with a higher capital cost, floating platform wind provides the ability to install wind turbines in the ocean in areas where wind regimes are excellent for wind production. Therefore, floating platform wind might achieve leveled electricity production costs that are lower than fixed bottom wind due to the superior capacity factors that can be achieved with optimal siting of the wind projects.

## H. Renewable Resource Options for O‘ahu

### Offshore Floating Platform Wind Energy

#### *Technical and Commercial Readiness*

As of 2016, floating platforms for wind energy generation are not technically or commercially ready. Only a handful of pilot projects have been installed. Thus far, the few pilot floating platform wind projects have required government subsidies to be built; capital markets are still reticent to providing commercial financing for floating platform wind projects.

However, there are reasons to be optimistic with respect to the use of floating platforms for offshore wind projects. Certain vendors, including Principle Power and its WindFloat® technology, have achieved success with the deployment of prototypes in representative environments, and are moving towards deployment of full-scale, multiple platform installations within the next two to three years. However, these first full-scale projects will heavily rely on subsidies or other government-backed financial guarantees.

#### *Interested Developers, Siting Process in Place*

Two different developers are proposing projects in Hawai‘i utilizing Principle Power’s WindFloat technology. This technology is considered to be the most advanced floating platform currently available, even though it still has to move beyond proof of concept into commercial status. A 25 MW project proposed off the Portugal coast for 2018 is expected to utilize the WindFloat technology<sup>7</sup> and, if successful, that project could signal that the technology is ready to be deployed on a commercial scale.<sup>8</sup>

Deployment of offshore floating platform wind in Hawai‘i is subject to a number of factors beyond just the technology. The U.S. Department of Interior Bureau of Ocean Energy Management (BOEM) leasing process for offshore sites has just started, and as part of that process, numerous stakeholders will need to be consulted including the U.S. Department of Defense, U.S. Fish and Wildlife, the Federal Aviation Administration, State of Hawai‘i Ports Division, and local interests including the local fishing industry. At least one of the developers has been active in engaging the community and the various agencies. BOEM issued a Notice of Call for Lease Proposals on June 24, 2016 providing a 45-day comment period by interested parties. The comment period was subsequently extended until September 7, 2016.

#### *Competing Uses for Port Facilities*

One of the primary cost advantages of floating offshore wind is the ability to assemble the platforms, with turbines installed, in port and then tow them into place. Two developers have indicated that they plan to construct and assemble each of the floating platforms, with towers and wind turbines, in a port facility in Hawai‘i. Port facilities in

<sup>7</sup> <http://www.offshorewindindustry.com/news/25-mw-floating-project-planned-portugal>.

<sup>8</sup> Principle Power’s technology was proposed for a 30 MW project off the coast of Oregon to be operational in 2017, but that project failed due to the failure to obtain a higher-than-market electricity price (driven by the still very high capital cost of the project). That project would have also required substantial government subsidies.

Hawai'i are subject to multiple competing uses particularly for importing goods and commodities for consumption within the State. There is a high demand for improvements to existing port facilities to accommodate existing and planned uses other than construction and fabrication of offshore wind platforms. Most of the demand for these improvements comes from those who have long-term needs, as opposed to offshore wind activities, which would represent a relatively short-term use of the constrained port space. Ultimately, the ability to utilize Hawai'i ports for offshore wind will come down to a policy decision by the State of Hawai'i.

### *Undersea Interconnections Required to Connect Offshore Wind*

Offshore wind projects are interconnected to the onshore power grid through a gathering system, operating in the 34.5 kV range, that feeds into a floating substation and steps up the power to match the onshore voltage (138 kV for O'ahu) for transmission and interconnection with the power grid. To date there has been very little experience with installing high capacity substations on floating platforms for operations in marine environments.

### *Capital Costs*

The potential to achieve economies of scale for floating platform wind is driven primarily by the size of the wind turbines installed on the floating platforms. The largest wind turbine currently available is 6 MW. It is likely that an 8 MW turbine will be available within a few years. Longer term, there is an expectation that individual wind turbines will become available in even larger sizes, perhaps as large as 20 MW per machine.

Capital costs for offshore floating wind are expected to come down as floating platform technologies mature, more projects are built (likely with government support), and ultimately become mainstream evidenced by the ability to access equity and debt markets without the need for subsidies.

The two known interested developers in Hawai'i have publicly stated that their projects would cost roughly \$1.6 Billion to \$1.8 Billion for each 400 MW project (or about \$4,000–\$4,500 per kilowatt) for commercial operation in the early 2020s. Based on available information, these cost targets appear to be optimistic, at least in the time frames proposed by the developers. However, given the high level of interest and effort in developing floating offshore wind technologies, it is likely that by the mid to late 2020s the technology will be considered commercial and prices will be competitive with fixed bottom wind project installations. If the industry indeed matures, it is not inconceivable that floating platform wind could become less expensive than fixed bottom wind projects (at least on a levelized cost per kilowatt-hour basis) since the capacity factors of offshore wind projects may generally be superior to land-based wind projects.



## H. Renewable Resource Options for O‘ahu

### Offshore Floating Platform Wind Energy

#### *Offshore Wind Viability*

Floating platform wind technology has a likelihood of achieving commercial status within the next 10 years, if not sooner. It is therefore an appropriate technology to consider in the PSIP analyses. Nevertheless, there are a number of substantial risks that could delay or even make it impossible to develop offshore wind in Hawai‘i. Most of these risks are beyond the control of the Companies. If offshore wind is to be developed as a viable resource option in the future, planning by authorities and regulators at both the State and Federal levels needs to begin as soon as possible so that potential impediments can be identified and policy decisions can be made that will preserve offshore wind (as well as interisland transmission cables and hydrokinetic technologies) as options for the future.

## Technology Review

Offshore floating platform wind technology has not yet been demonstrated at full scale. It is possible that floating platform wind will reach cost parity with fixed foundation wind platforms by the mid-2020s, however government support for full-scale demonstrations is required for this to be achieved. Full scale demonstrations are needed to bridge the gap between the pre-commercial status of floating platforms today and full commercial status where there are economies of scale across the industry to drive costs down to competitive levels, where private equity and debt investors will have the confidence to invest, developers will have the confidence to take development risk around projects employing this technology, and most importantly, utilities will consider the cost and technology risk acceptable to their ratepayers.

Platform size is a challenge to commercialization, since larger platform sizes accommodate larger turbines, which in turn leads to lower per-unit costs of installation. Installation procedures will also need to be developed to ensure efficient deployment of the platforms during the development phase. A set of standards for offshore floating platforms is under development. In the case of the semi-submersible platform technology being proposed for Hawai‘i, leading platform technology providers are currently working on perfecting the control systems that stabilize the platforms. Floating substation platforms also need to be perfected as only one floating substation has been deployed to date (in Japan).

## Types of Floating Platform Technologies

The primary function of the floating platform is to provide a stable platform that will allow the installed wind turbine to remain in a fixed position relative to the wind orientation so that maximum energy production is achieved. In open ocean environments, such as that found in Hawaiian waters, this is a substantial design requirement. There are three basic technology types under consideration for offshore floating platform wind, all derived from the offshore oil and gas industry:

**Spar Buoy.** The spar buoy platform maintains stability through use of a heavy cylindrical buoy that is submerged well below the top of the platform so that the center of gravity of the overall structure is very low, while the center of buoyancy is high (that is, at the top of the platform). The deep draft of the spar buoy, and the relative difficulty of constructing it, typically limits the spar buoy technology to shallower waters (that is, less than 100 meters). Advantages include simple design, and no active ballast system. Disadvantages include the need for construction at the site requiring heavy-lift cranes mounted on vessels, and the inability to tow the platform into port for repairs if needed.

**Semi-Submersible.** The semi-submersible platform floats on the surface of the ocean, with its structure partially submerged in the water. A dynamic control system maintains the stability and orientation of the platform using an active ballast system. The semi-submersible platform utilizes mooring lines attached to the ocean floor to anchor the platform in place, however the control system, not the mooring lines, provides the primary stability of the platform. Semi-submersible platforms can be utilized in deep waters (less than 1,000 meters). Advantages of semi-submersible structures include the ability to construct the platform in a port and then tow the completed platform into place. Disadvantages include the need for complex welded steel structures and a costly control system.

**Tension Leg Platform.** The tension leg platform is similar to the semi-submersible concept, however the stability of the platform is provided by the tensioned mooring lines themselves. This allows for a lighter structure, but it also increases the mechanical forces on the mooring lines and floor anchors. Failure of a tensioned mooring line can create substantial operational challenges. The major advantages of the tension leg platform technology are the ability to assemble the platform onshore, and the lack of a need for an active ballast system.

## H. Renewable Resource Options for O‘ahu

### Offshore Floating Platform Wind Energy

Figure H-11 shows an artist’s depiction of these three technology types.

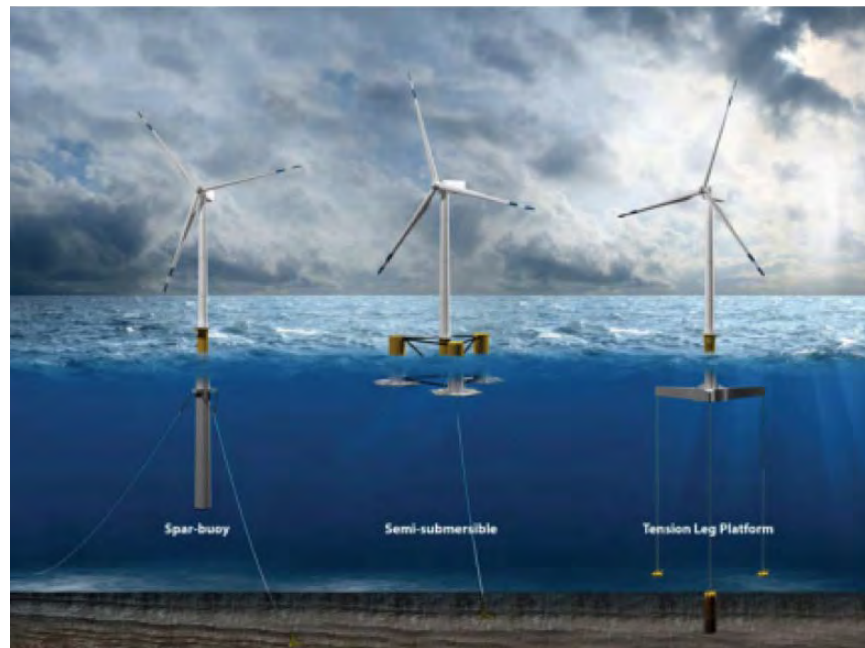

Figure H-11. Types of Offshore Wind Floating Platforms<sup>9</sup>

Two of the commercial proposals for offshore floating platform wind in Hawaiian waters indicate that they plan to utilize semi-submersible platforms, in particular the WindFloat technology being developed by Principle Power (Figure H-12). According to Principle Power’s website, to date, a single WindFloat installation has actually been achieved. That prototype installation utilizes a 2 MW wind turbine, and was installed in 2011 approximately 5 kilometers off the coast of Aguçadoura, Portugal. The platform was assembled and commissioned onshore before being towed 400 kilometers along the Portuguese coast from its assembly facility.<sup>10</sup>

The WindFloat product is one of the most technologically advanced floating platform technologies, although it has yet to achieve commercial status. Further, semi-submersible technology, in particular the WindFloat product, is suited for the extremely deep water installation environment proposed in Hawai‘i.

A European-based developer has indicated privately to the Companies that it also intends to propose an offshore wind project in Hawai‘i utilizing the spar buoy technology. No details of that proposal have yet been made public.

<sup>9</sup> Illustration by Josh Bauer, National Renewable Energy Laboratory, obtained from *Floating Offshore Wind in Hawai‘i: Potential for Jobs and Economic Impacts from Two Future Scenarios* Tony Jimenez, David Keyser, and Suzanne Tegen National Renewable Energy Laboratory, April 2016. Prepared for BOEM, OCS Study BOEM 2016-032.

<sup>10</sup> See: <http://www.principlepowerinc.com/>

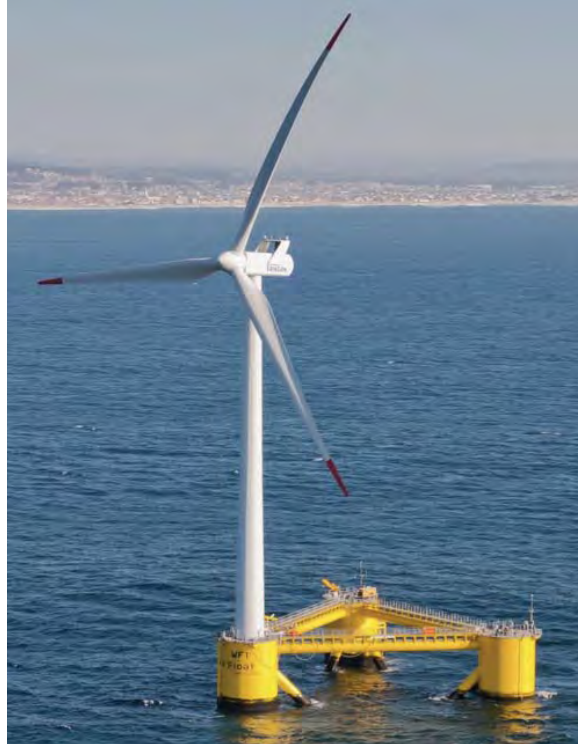

Figure H-12. WindFloat Prototype<sup>11</sup>

### Platform Anchoring Systems

Semi-submersible floating platforms utilize a control system to maintain stability. The platform itself is anchored in place with a catenary system that is typically made up of steel chains whose weight holds the platform in place. Principle Power had planned to utilize three anchors per platform in an Oregon project. The lower section of the chain rests on the seabed and is secured to the ocean floor. In sandy and clay seabed conditions, the anchoring system utilizes drag-embedded anchors, which are completely recoverable during decommissioning. The drag-embedded anchoring system is based on existing technology used in oil and gas platforms. The system is relatively simple to install since it does not require permanent pilings to fasten to the seafloor. This also makes it simple to decommission. The main drawback is the larger seafloor footprint required relative to driven pile anchors. The typical radius catenary mooring footprint radius is about 600 meters.<sup>12</sup> If the seabed conditions in Hawai'i are not conducive to drag anchors (that is, rather than sand or clay, the bottom is rock), then driven pile type anchors will be required. In general, the type of anchoring system is site specific.

<sup>11</sup> Source: Alpha Wind Energy, Hawai'i Offshore Wind Energy Lease Application O'ahu Northwest (Public Version), January 2015. Cover.

<sup>12</sup> Figure 3.1.13, p 87. *Floating Offshore Wind: Market & Technology Review*. June 2015. The Carbon Trust.

## H. Renewable Resource Options for O‘ahu

### Offshore Floating Platform Wind Energy

#### Offshore Wind Turbines

The largest installed offshore wind turbine is currently 6 MW; however, 8 MW turbines are slated for commercial introduction in the near future. Typically, the increase in the size of wind turbines is an evolution of previous designs, rather than development of a totally new concept.<sup>13</sup> Thus, it is likely that by the time a project is ready for development in Hawai‘i, larger turbine sizes may become available. Larger turbines mean fewer platforms and greater energy production per platform.

#### Submarine Cabling Systems

Submarine cabling systems are based on mature technologies. Wind facilities require a web of undersea cables, which have a significant instance of failure and resulting insurance claims within the offshore wind industry.<sup>14</sup> Typically, the installation of an undersea cable is a specialized undertaking that requires an experienced installer with special equipment. There are only a handful of such specialized installers in the world. Thus, during the construction phase, care must be taken to install and test submarine cables.

#### Technology Readiness

Energy technologies can be rated for their readiness in the marketplace through a Technology Readiness Level (TRL) system. The TRL levels, as defined by the U.S. Department of Energy, are described in Table H-7.

---

<sup>13</sup> <http://www.renewableenergyworld.com/articles/print/volume-19/issue-9/features/wind0/understanding-risk-for-new-wind-technology-in-new-wind-markets.html>.

<sup>14</sup> *Ibid.*

Relative Level of Technology Development	TRL	TRL Description
System Operations	TRL 9	Deployment. Technology in final form and operated over full range of operating mission conditions.
System Commissioning	TRL 8	End of system development. Technology proven to work in its final form and under expected conditions.
	TRL 7	Full-scale prototype demonstrated in a relevant environment.
Technology Demonstration	TRL 6	Engineering-scale or pilot-scale models or prototypes tested in a relevant environment.
Technology Development	TRL 5	Laboratory scale, similar to a system validation in a relevant environment. Laboratory system tested in a simulated environment. System configuration similar to final application in all respects.
	TRL 4	Component or system validated in a laboratory environment. Basic technological components integrated to establish that the separate elements will work together in a laboratory environment.
Research to Prove Feasibility	TRL 3	Analytical and experimental critical function or characteristic proof of concept. Active research and development is initiated. Physical validation of analytical predictions of separate elements of the technology.
	TRL 2	Technology concept or its application formulated. Invent practical applications of the technology. Applications are speculative.
Basic Technology Research	TRL 1	Basic technology principles observed and reported. Scientific research beings to be translated into applied research and development.

Table H-7. Technology Readiness Levels<sup>15</sup>

With the deployment in 2011 and extensive testing of the 2 MW WindFloat project over a period of years in Portugal, the WindFloat technology has achieved deployment of an “engineering scale prototype in a relevant environment” and thus qualifies as a TRL Level 6.

Principal Power had been planning to install a full-scale prototype off the coast of Oregon in 2017.<sup>16</sup> However, Principle Power withdrew its application for a lease through BOEM, who states that it is “no longer processing this application” for the Oregon project.<sup>17</sup>

In the meantime, Principle Power continues to pursue a full-scale project off the Portuguese coast. The WindFloat Atlantic (WFA) project is planned to be operational in 2018 and “will consist of three or four wind turbines on floating foundations” with a total capacity of 25 MW. The WFA project is supported by the European Commission through the NER 300 program, the Portuguese Government through the Portuguese Carbon

<sup>15</sup> *Technology Readiness Assessment Guide*; U.S. Department of Energy, DOE G 413.3-4A, September 15, 2011. Adapted from Table 1: Technology Readiness Levels, pages 9–10.

<sup>16</sup> <http://windfloatpacific.com/faqs/>.

<sup>17</sup> <http://www.boem.gov/windfloatpacific/>.

## H. Renewable Resource Options for O‘ahu

### Offshore Floating Platform Wind Energy

Fund, and the InnovFin program by the European Investment Bank. The stated aim of the project is “to demonstrate the economic potential and reliability of this technology, advancing it further in the path towards commercialization.”<sup>18</sup> In other words, successful deployment of the WFA project, or another similarly scaled project, would constitute a full-scale prototype demonstrated in a relevant environment and thereby qualify as a TRL Level 7. Successful operation of this pilot project over a period of one to two years would qualify the technology as TRL Level 8. Thus, this technology could reach *technical* maturity in the early 2020s.

### Commercial Readiness

Technology readiness should not be confused with commercial readiness. The Australian Renewable Energy Agency (ARENA) developed a Commercial Readiness Index (CRI) in February 2014.<sup>19</sup> The CRI scale assesses technology readiness against a number of practical indicators including the financial proposition, regulatory environment, industry supply chain and skills, market opportunities, and vendor maturity (that is, established companies with strong credit ratings).

CRI Level	Commercial Readiness	Definition
6	Bankable grade asset class	Financial investors view the technology risk as low enough to provide long-term financing (that is, bankable). Known standards and performance expectations are in place, along with appropriate warranties. Vendor capabilities (including both technology vendors and EPC vendors), pricing, and other market forces drive market uptake (“demand pull”).
5	Market competition driving widespread deployment	Emerging competition across all areas of the supply chain with commoditization of key components and financial products occurring.
4	Multiple commercial applications	Full-scale technology demonstrated in an industrial (not R&D) environment for a defined period of time. May still require subsidies. Publicly verifiable data on technical and financial performance. Interest from debt and equity sources, although still requiring government support. Regulatory challenges being addressed in multiple jurisdictions.
3	Commercial scale-up	Deployment of full-scale technology prototype driven by specific policy. The commercial proposition is driven by technology proponents and market segment participants (a “supply push”). Publicly discoverable data is driving interest from finance and regulatory sectors, but financing products not yet widely available. Continues to rely on subsidies.
2	Commercial trial	Small scale, first of a kind project funded by equity 100% at risk and/or government support. Commercial proposition backed by evidence of verifiable performance data typically not available to the public. Proves the essential elements of the technology perform as designed.
1	Hypothetical commercial proposition	Technically ready, but commercially untested and unproven. The commercial proposition is driven by technology advocates with little or no evidence of verifiable technical data to substantiate claims.
0	Purely hypothetical	Not technically ready. No testing at scale. No technical data.

Table H-8. Commercial Readiness Levels

<sup>18</sup> <http://nawindpower.com/principle-powers-technology-inspires-consortium-to-build-floating-wind-farm-off-of-portugal>

<sup>19</sup> Based on *Commercial Readiness Index for Renewable Energy Sectors*. Australian Renewable Energy Agency. ©Commonwealth of Australia, February 2014. Table 1, page 5.

Based on Principle Power’s success to date, the WindFloat could be considered to have achieved CRI Level 2—deploying an engineering scale prototype, but not yet demonstrating the technology at a full commercial scale. With the planned full-scale prototype planned for 2017, the WindFloat would achieve CRI Level 3. However, CRI Level 3 is still far below CRI Level 6, where the technology is considered bankable. Using the capital cost estimates of approximately \$4,000 per kilowatt, 800 MW of offshore floating platform wind would require \$3.2 Billion in capital. Developers with proposals for Hawai‘i that utilize the WindFloat technology would likely face a financing environment where few, if any, debt and equity providers would provide this massive amount of capital.

Note that the 25 MW WFA project proposed for Portugal will rely largely on government subsidies for financing. Thus, while the WindFloat technology could reach *technical* maturity in the next three to five years, it could take substantially longer for the sources of commercial financing to materialize to support development in Hawai‘i of the hundreds of MW of offshore wind proposed by developers.

### Developer Interest

Currently two developers—Alpha Wind Energy and Progression Energy—are known to be proposing offshore wind facilities in the waters around O‘ahu (based on the unsolicited lease proposals submitted to BOEM).<sup>20</sup> At the BOEM Task Force Meeting in Honolulu on May 16, 2016, BOEM representatives stated that they are aware of a third developer who may submit a lease application as part of a competitive leasing process for offshore wind blocks near O‘ahu.

#### Alpha Wind Energy

Alpha Wind Energy (dba AW Hawai‘i Wind LLC) proposes to develop 400 MW of offshore wind near O‘ahu “with the option to expand further.” Alpha has submitted lease proposals to BOEM for two different sites near O‘ahu.

Alpha states that the majority of the main components for the wind facility will be produced or assembled in Hawai‘i creating 100 permanent jobs. Alpha states in its BOEM Lease Application that it has consulted with the State Harbors Division and has confirmed that suitable harbors are available for “manufacturing, servicing, and maintenance” of the proposed wind project. A port area of 100,000 m<sup>2</sup> (24.7 acres) is required. Alpha also states that “most main components will be produced elsewhere and shipped to Hawai‘i for assembly.” The assembly is to be accomplished in dry docks and

---

<sup>20</sup> The unsolicited lease proposals are available for download at <http://www.boem.gov/Hawaii/>.



## H. Renewable Resource Options for O‘ahu

### Offshore Floating Platform Wind Energy

the fully commissioned turbines will be towed and connected to pre-installed anchors and electrical cables. 8 MW turbines are envisioned.

Alpha plans to initially construct an offshore floating substation that will be fed by a collection grid energized at 33–69 kV. The substation will feed power via a single power cable to O‘ahu energized at either 69 kV or 138 kV. Alpha proposes to interconnect the wind facility to the O‘ahu grid at one or more of the following points: Kahe Power Plant, Barbers Point industrial area, or Wahiawa substation. Alpha states that the project could be expanded in the future with interconnections via a “loop connection” and possibly to Maui, Moloka‘i, and Lana‘i via undersea cables.

In its BOEM Lease Application, Alpha proposes to begin construction in mid-2018 and energize the first turbine to begin delivering power by early 2020. Alpha recognizes in its BOEM Lease Application that this is a “very aggressive” schedule that will “take every effort at all levels” to meet.

### Progression Energy

Progression Energy proposes to construct an offshore 400 MW wind facility southeast of O‘ahu. The project will consist of between 40 and 50 floating platforms sited in waters with an average depth of 2,700 feet. Each platform will have an 8 MW to 10 MW turbine. Progression plans to utilize the “WindFloat” semi-submersible floating foundation from Principal Power.

The project will be built in two, 200 MW phases. Progression’s offshore wind facility will include a collection system of power cables energized at 34.5 kV. Power from the individual turbines will be sent via the collection system to a floating substation centrally located within the wind turbine arrays. Each 200 MW phase of the project will utilize two 105 MVA 34.5/138 kV transformers. Each phase of the project will be interconnected to the O‘ahu grid via 138 kV undersea cables. Two separate interconnections, one for each phase of the project, are planned.

Progression intends to utilize a local supply chain for professional services, harbor facilities, vessels, and components involved in the “fabrication and/or assembly, deployment and operation and maintenance” of its project. Construction of the project will require a construction port with laydown space that will serve as the staging area for assembly of the WindFloat platforms and wind turbines. The port facilities must also have sufficient berthing space for loading and unloading.

Progression states that it will include local sourcing provisions in its larger contracts. Progression plans to offer training, educational, and research opportunities, as well as a community benefits program.

To create a “highest likelihood for success,” Progression states that it has met with over 100 stakeholders to educate the community about the project, and select an offshore site that will be acceptable across a number of different interests, including the U.S.

Department of Defense.

Progression proposes to begin construction of the first 200 MW phase of the project in late 2020 and begin commercial operation in early 2022. The second 200 MW phase of the project would begin construction in late 2021 and would achieve commercial operation in early 2023.

### Alpha Wind and Progression Energy Unsolicited Lease Proposals

Figure H-13 depicts the locations of the Alpha Wind Energy (AWH) and Progression Energy lease proposals as submitted to BOEM.

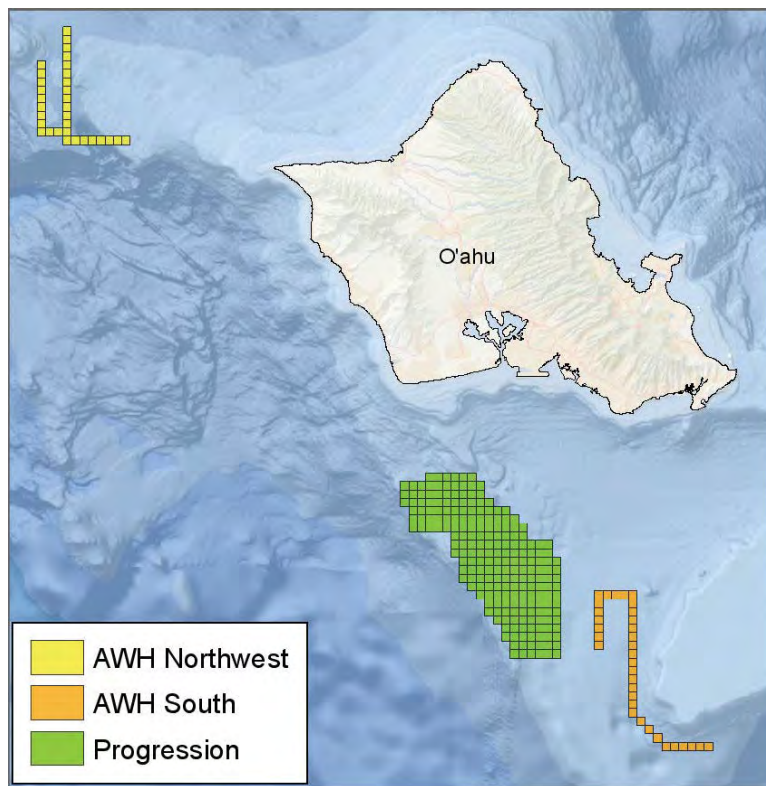

Figure H-13. O'ahu Unsolicited Lease Proposals Received by BOEM

## H. Renewable Resource Options for O‘ahu

### Offshore Floating Platform Wind Energy

## Capital Cost Assessment

Because floating platform wind technology is not yet a fully mature technology, there is considerable uncertainty as to the future capital cost of commercial offshore floating platform wind projects. There are several competing technical concepts, the most advanced of which is the semi-submersible platform concept. Principle Power’s WindFloat design is one of the most advanced concepts. However, additional deployments of this technology are needed to perfect the technology and assess the commercial cost in the future. Project costs will also be influenced by site conditions, availability and proximity of port infrastructure, supply chain capabilities, and the local permitting environment.

### Developer Capital Cost Estimates

The two known interested developers of offshore wind have made public statements regarding the cost of offshore wind. Progression Energy claims that it can develop a 400 MW project for \$1.8 Billion or about \$4,500 per kilowatt.<sup>21</sup> Alpha Wind Energy says it can develop a 408 MW project for \$1.9 Billion or about \$4,657 per kilowatt.<sup>22</sup> Both developers say that they can deliver a completed project in the 2019–2022 timeframe.

### The Carbon Trust Capital Cost Estimates

The Carbon Trust report for the Scottish Government did not provide a year-by-year projection of the capital cost of offshore floating platform wind; however, it did provide several data points regarding the cost at various stages of technological development. Table H-9 shows the Carbon Trust estimates of capital cost (in U.S. \$/KW, converted from € at an exchange rate of \$1.12 / €1.00).

Technological Maturity	Capital Cost in U.S. \$/KW
Prototype	\$5,824
Pre-Commercial	\$4,704
Commercial	\$3,024

Table H-9. Offshore Floating Platform Wind Capital Cost Estimates<sup>23</sup>

The Carbon Trust reported these figures with a strong caveat:

<sup>21</sup> <http://phys.org/news/2016-05-companies-deep-water-farms-hawaii-shores.html>.

<sup>22</sup> <http://www.governorswindenergycoalition.org/?p=12234>.

<sup>23</sup> *Floating Offshore Wind: Market and Technology Review*, Prepared for the Scottish Government, June 2015. Table 3.5.2, page 125.

The uncertainty associated with the data is largely associated with the nascent state of the technology. Very few floating wind devices have been deployed at full-scale and those which have consist of single prototype demonstrations, which have not had to contend with the additional challenges encountered in commercial-scale deployments, such as high voltage electrical transmission, wake effects, batch fabrication and installation procedures, O&M, logistics, etc.

Furthermore, Carbon Trust experience suggests that the cost of innovative technologies can increase from initial conception to demonstration phase, before falling as the design is optimized and deployment increases. Given that most of the concepts assessed are in the early stages of development and may be nearer the beginning of this cost curve, it is possible that the cost estimates underestimate the full costs of deploying the technology.<sup>24</sup>

The Carbon Trust report was published in 2015, so presumably the figures stated above are 2015 cost levels. Notwithstanding the reference year, The Carbon Trust capital cost estimates and their qualifications on such estimates are not a strong basis for projecting the capital cost of floating platform wind projects for use in a utility planning study.

### NREL Capital Cost Estimates

NREL provides capital cost projections for various power generating technologies in its Annual Technology Baseline (ATB). NREL finalized the 2016 ATB in August 2016 and included several offshore wind technologies including floating platform technologies. The reference plant was described by NREL as approximately 500 MW in size, deployed on floating platforms in deep water (61–700 meters).

The plant envelope includes:<sup>25</sup>

- Wind turbine
- Turbine installation
- Substructure supply and installation site preparation
- Port and staging area support for delivery, storage, and handling
- Underground utilities installation
- Electrical infrastructure such as transformers, switchgear, and electrical system connecting turbines to each other and to a control center
- Project indirect costs including engineering, distributable labor, and materials
- Construction management start-up and commissioning
- Contractor overhead costs, fees, and profit

<sup>24</sup> *Ibid.*, page 124. Edited to remove references to figures not included here.

<sup>25</sup> *ATB Summary Presentation – 2016 Final*, pp 23-30. Available at <http://www.nrel.gov/docs/fy16osti/66944.pdf>.

## H. Renewable Resource Options for O‘ahu

### Offshore Floating Platform Wind Energy

- Financial costs such as development costs, preliminary feasibility and engineering studies, environmental studies and permitting, legal fees, insurance costs, and property taxes during construction
- Onsite electrical equipment (for example, a switchyard)
- A nominal-distance spur line

NREL’s ATB Summary presentation also states that “... floating technology is not yet commercial and no market comparison data exists.”<sup>26</sup> NREL provided a low, mid, and high range of capital cost projections. NREL states that the projections depend on the degree of adoption. The degree to which the low, mid, or high ranges will come to fruition are based on how the following trends play out over time:

- Continued scaling to larger MW turbines with greater efficiencies.
- Competition for primary components and services necessary to construct projects (for example, turbines, support structure, and installation).
- Economy of scale and productivity improvements in the production and installation of sub-structures and components.
- Improved plant siting and operation to reduce plant level energy losses, thus increasing its capacity factor.
- Efficient operation and maintenance procedures combined with more reliable components to reduce fixed O&M costs.
- Adoption and innovation in control systems, materials, and design.

Before the release of the 2016 ATB and during the development of the planning input assumptions for the April 2016 updated PSIP, the use of the 2015 version of the ATB was called into question by one of the known Hawai‘i offshore wind project developers. This developer stated that an internal team at NREL with expertise in offshore wind had developed offshore wind capital costs that were different (and lower) than the 2015 ATB projections. This led to several dialogues with NREL and its offshore wind experts. Two salient data points were obtained from these dialogues:

- The deep water, floating platform, low-case capital cost “trajectory” reaches approximately \$5,300 per kilowatt in 2020 according to Aaron Smith of NREL.<sup>27</sup>
- The earliest date for a commercial offshore floating platform wind project is likely 10 years away, “maybe” as early as 2025. The technology will likely become commercial but “lots” of technical hurdles remain.<sup>28</sup>

---

<sup>26</sup> *Ibid.*

<sup>27</sup> Wesley Cole of NREL email to HDBaker & Company, January 15, 2016. This number was qualified as lacking full review and was characterized as “preliminary”.

<sup>28</sup> Lisa Giang of Hawaiian Electric, Hugh Baker of HDBaker & Company telephone call with Walt Musial of NREL on April 22, 2016.

### Capital Cost Recommendations for 2016 PSIP

Because the technology has not reached commercial status, there is considerable uncertainty as to the actual capital costs for offshore floating platform wind. In early 2016, after conversations with NREL and its offshore wind experts, the Companies decided to use the “unofficial” \$5,300 per kilowatt capital cost estimate for 2020 as the basis for the PSIP assumptions. This amount was adjusted by a factor of 1.138 to reflect the Hawai‘i’s higher installation cost,<sup>29</sup> for a total nominal capital cost of \$6,031 in 2020.

Figure H-14 graphs these various capital cost values. For a consistent comparison, the PSIP capital cost assumption has removed the Hawai‘i location factor. The PSIP capital cost numbers have been adjusted to 2014 dollars (to be consistent with the NREL ATB). These PSIP capital cost assumptions are below the 2016 NREL ATB (indicating a more pessimistic view of capital cost declines by NREL) and are slightly higher than the two developer estimates in the early years. The Carbon Trust estimate for fully commercialized offshore wind is well below all of the other estimates, reflecting The Carbon Trust’s view of the capital cost when there is a robust market for offshore wind. The PSIP assumption for offshore wind capital cost approaches The Carbon Trust commercial value towards the end of the projection horizon.

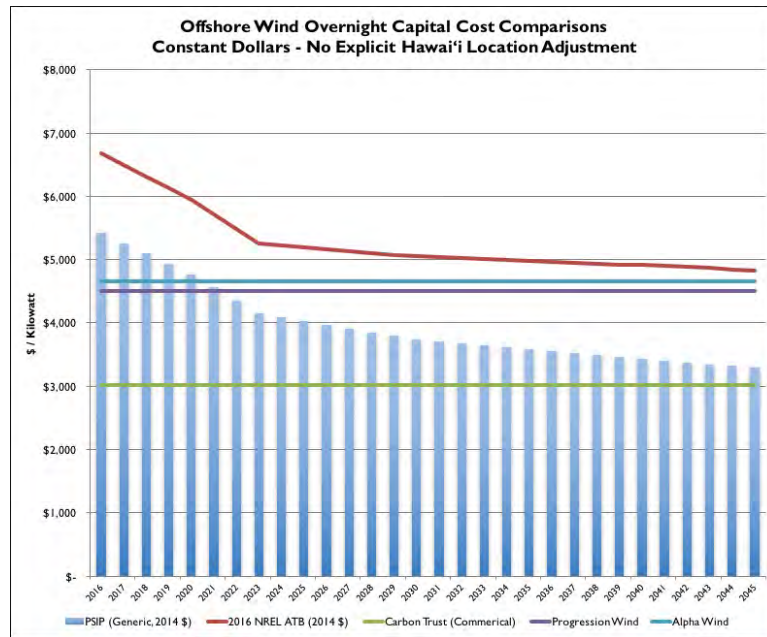

Figure H-14. Offshore Floating Platform Wind Capital Cost Projections and Comparisons

<sup>29</sup> The source of this adjustment factor is the U.S. Energy Information Administration report *Updated Capital Cost Estimates for Utility Scale Electricity*, April 2013.

## H. Renewable Resource Options for O‘ahu

### Offshore Floating Platform Wind Energy

Based on this research, the capital cost projection prepared for the 2016 PSIP update appears to be a reasonable projection given the considerable uncertainty around the technological maturation and commercialization time lines associated with this technology. The Companies plan to continue monitoring developments in offshore floating platform wind technology as the technology matures, particularly as it relates to capital cost improvements.

## Project Development

BOEM is the lead agency for siting offshore wind facilities. BOEM has authority over energy projects in federal waters. Historically, BOEM’s activities have primarily related to offshore oil and gas exploration and production, but more recently, there has been interest in developing offshore wind energy projects, particularly along the U.S. eastern seaboard. Thus far, BOEM has issued 11 leases for offshore wind energy projects located in Rhode Island, New York, and Virginia. BOEM has four unsolicited lease proposals in federal waters in the Pacific Ocean, including three in Hawai‘i and one in California.

BOEM views its role as defining a consistent permitting process for offshore wind in the United States. BOEM seeks to balance the needs of all ocean users and is currently engaged in an extensive stakeholder process. BOEM stresses that, in Hawai‘i, it is in the middle of a process and the outcome is far from certain.<sup>30</sup>

### *Potential Offshore Wind Lease Areas in Hawai‘i*

For Hawai‘i, BOEM has identified a number of potential areas (“Call Areas”) for offshore wind development and has defined certain potential lease blocks.<sup>31</sup> Areas thought to be suitable by BOEM for offshore wind development in Hawai‘i were determined through a process of inclusions and exclusions around the following criteria:

- The proposed lease areas must be within BOEM authority.
- The proposed lease areas must have acceptable wind speeds.
- Water depths must be less than 1,100 meters (BOEM’s opinion of the maximum reasonable depth for offshore wind feasibility).
- The lease areas must not include any areas where bottom dwelling fish are protected.
- The lease areas must be outside whale sanctuaries.
- Areas with high vessel traffic (as determined by BOEM’s analysis of vessel traffic patterns) must be excluded.

<sup>30</sup> Abigail Ross-Hopper, Director of BOEM, statement at the May 16, 2016 BOEM Hawai‘i Offshore Wind Task Force meeting in Honolulu, Hawai‘i.

<sup>31</sup> A standard OCS block is 4800 meters square containing 2304 hectares (5693.3 acres) or about 9 square statute miles.

Based on this criteria, BOEM identified two “sub-areas” within the O‘ahu Call Area:

1. O‘ahu North, located approximately 7–24 nautical miles west of Kaena Point, O‘ahu, consists of 17 full and 20 partial Outer Continental Shelf (OCS) blocks.
2. O‘ahu South, located approximately 7–35 nautical miles south of Barbers Point, O‘ahu, consists of 44 full and 32 partial OCS blocks.

Figure H-15 shows a map of these O‘ahu Call Areas graphed on a 2.5 by 2.5 nautical mile grid.

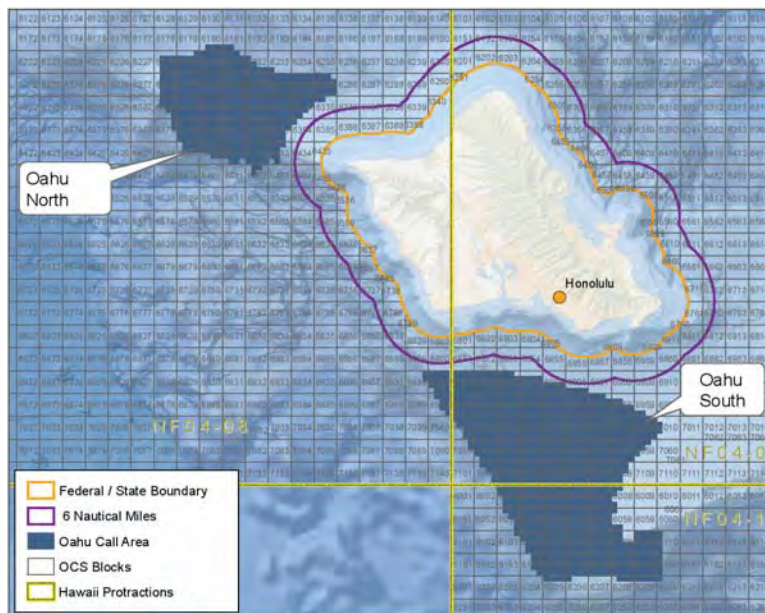

Figure H-15. BOEM Designated O‘ahu Call Areas

At a May 16, 2016 Task Force meeting, BOEM stated that the vessel traffic area exclusions had so far *not* taken into account U.S. Navy Pacific Fleet operations. A representative of the Pacific Fleet indicated that the Navy would like to provide classified information to BOEM to ensure that the Navy’s operations are considered. On May 25, 2016, the Navy published a map showing zones that were “Incompatible with Department of Navy Operational and Readiness Activities.”



## H. Renewable Resource Options for O'ahu

### Offshore Floating Platform Wind Energy

Figure H-16 shows that a large portion of the BOEM Call Areas fall into this incompatible zone. In addition, virtually all of the blocks that Alpha Wind and Progression Energy propose to develop are located within these incompatible zones. This should *not* be construed to preclude development of offshore wind around O'ahu. BOEM has contracted with NREL to develop more detailed information to assist BOEM and the U.S. Navy to further investigate how offshore wind can coexist with the Navy's operations and training missions.<sup>32</sup> As of early September 2016, this work is underway.

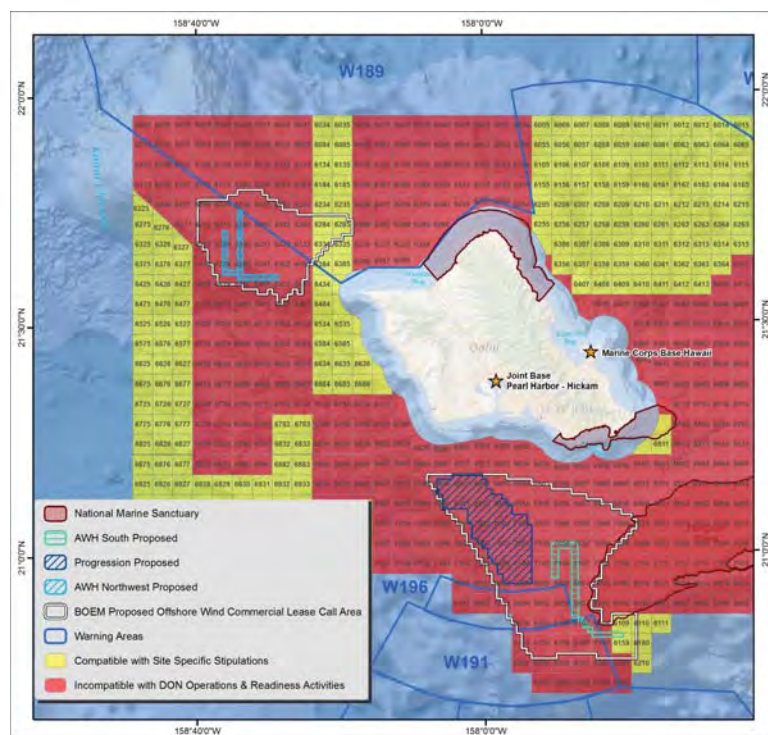

Figure H-16. Navy Incompatible O'ahu Call Areas and Unsolicited Lease Proposals<sup>33</sup>

### BOEM Lease Process

On June 24, 2016, BOEM issued a Call for Information and Nominations (Call), inviting "... the submission of information and nominations from parties interested in obtaining one or more commercial wind energy leases that would allow lessees to propose the construction of wind energy projects on the Outer Continental Shelf offshore the island of O'ahu, Hawai'i."<sup>34</sup> This is the first step in the BOEM leasing process.

<sup>32</sup> Telephone conversation with Walt Musial and Robi Robinchaud of National Renewable Energy Laboratory. September 8, 2016.

<sup>33</sup> <http://greenfleet.dodlive.mil/rsc/department-of-the-navy-hawaii-offshore-wind-compatibility/>.

<sup>34</sup> *Federal Register*, Vol. 81, No. 122, Friday, June 24, 2016, Notices, p 41335.

BOEM determines if competitive interest exists for blocks within the Call Area. If so, BOEM then moves to a competitive auction process (with appropriate public notices in advance of the “Sale Notice”). If there is no competitive interest, then BOEM may negotiate a lease directly with a project developer. For example, in the case of the unsolicited lease proposals submitted to BOEM so far, unless there is an interest from other parties in leasing the same blocks, BOEM may choose to negotiate directly with these two project developers.

Upon award of a lease, the developer has one year to develop a Site Assessment Plan (SAP). BOEM then conducts environmental and technical reviews of the SAP. BOEM can approve, approve with modifications, or disapprove the SAP.

If the SAP is approved (or modified to meet BOEM’s concerns), the developer then begins additional site assessment studies, including installation of meteorological towers, buoys, or both. The developer has five years from approval of the SAP to submit a Construction and Operations Plan (COP). The SAP and COP form the basis for the detailed environmental (including the EIS) and technical reviews. When the COP is approved (and all other required permits and approvals are obtained), the developer can begin construction of the project.

At the May 16, 2016 BOEM Task Force meeting, representatives of BOEM stated that the entire process could take 5 to 10 years to complete, which would support a construction start date no earlier than 2021.

## Environmental and Permitting

Besides obtaining a lease from BOEM and complying with the lease conditions, a variety of permits and approvals will be required to construct and operate an offshore wind project. The interested agencies include, but are not limited to:<sup>35</sup>

- U.S. Navy (including the Pacific Fleet and Marine Corps)
- U.S. Coast Guard
- U.S. Army Corps of Engineers
- U.S. Department of Commerce, National Oceanic and Atmospheric Administration
- Hawai‘i Humpback Whale National Marine Sanctuary
- National Ocean Service
- National Marine Fisheries
- U.S. Department of Interior

---

<sup>35</sup> This list is based on information from BOEM, but is not intended to be a comprehensive list of all of the permitting agencies and public consultations that would be involved in the development of an offshore wind project in Hawaiian waters.

## H. Renewable Resource Options for O‘ahu

### Offshore Floating Platform Wind Energy

- Fish and Wildlife Service
- National Park Service
- Federal Aviation Administration
- Environmental Protection Agency
- Council on Environmental Quality
- Advisory Council on Historic Preservation
- State of Hawai‘i Department of Land and Natural Resources
- State of Hawai‘i Department of Transportation Harbors Division
- State of Hawai‘i Department of Business, Economic Development, and Tourism
- State of Hawai‘i Office of Hawaiian Affairs

Other stakeholders with potential interests in an offshore wind project in Hawai‘i may include:

- Commercial fishing interests
- Commercial marine shipping
- Commercial ocean tour businesses
- Recreational ocean users
- Local communities impacted by any visual impacts, cable landings, new on-land infrastructure, etc.
- Non-governmental organizations.

An offshore wind project constructed to serve electric loads on O‘ahu will need to execute a Power Purchase Agreement with the Companies. Any PPA will be subject to successful negotiations, including price, schedule, and technical considerations. The PPA must be approved by the Hawai‘i Public Utilities Commission. Such an approval process is likely to be a litigated proceeding, extending the time until construction could possibly begin.

While obtaining the approvals for offshore wind projects requires a process similar to other energy development projects, the installation of floating platforms in 700–1,000 meter deep waters as proposed in Hawai‘i, with high voltage subsea electrical interconnections to land, has never been done before anywhere in the world. Therefore, there are potential unknowns about the permitting process and community acceptance that pose development risks. It is therefore likely that any successful approval process will be lengthy, complicated, and potentially contentious.

### *National Environmental Policy Act (NEPA)*

The National Environmental Policy Act (NEPA) requires Federal agencies to consider environmental factors when making decisions. For an offshore wind project in Hawai‘i, BOEM is the designated Federal lead agency for ensuring that NEPA requirements are met.

As the lead agency, it is BOEM’s responsibility to:

- Involve affected and interested members of the public.
- Coordinate the environmental review by other affected Federal agencies.
- Evaluate relevant environmental factors and potential mitigation of environmental impacts.
- Document the environmental affects by preparing an Environmental Impact Statement (EIS).

To evaluate potential leases, BOEM will do two NEPA reviews. The first NEPA review will occur before to the award of leases. This review will analyze resource and site characteristic assessments to inform BOEM about areas acceptable to be leased.

The second NEPA review will take place after the award of the leases and the developer’s submission to BOEM of a SAP and Environmental Assessment. During this period, the develop will create a site COP. Before starting construction, another NEPA analysis, most certainly an EIS, will need to be completed. Typically the EIS is scoped to include all of the factors that must be addressed under NEPA, as well as factors that may be specific to the State (for example, the Hawai‘i Environmental Policy Act)<sup>36</sup> or locale where the project is planned. That avoids duplication of efforts while meeting multiple jurisdictional requirements.

---

<sup>36</sup> Some NEPA and HEPA requirements overlap; important differences exist in others. Thus, it is generally more efficient to prepare an EIS that addresses the requirements of both.

## H. Renewable Resource Options for O‘ahu

### Offshore Floating Platform Wind Energy

In September 2015, the U.S. Department of Energy finalized a Programmatic Environmental Impact Statement (PEIS) that analyzed “... the potential environmental impacts, and best management practices that could minimize or prevent those potential environmental impacts, associated with 31 clean energy technologies and activities...”<sup>37</sup>

The Hawai‘i Clean Energy PEIS indicated that the State of Hawai‘i has particular interest in four environmental resource areas:

- Biological resources
- Land and submerged land use
- Cultural and historic resources
- Scenic and visual resources

BOEM has already begun to address some of these issues through a series of studies, some completed and some ongoing.

### Construction

Successful construction of offshore floating platform wind projects depends on the availability of port facilities for assembly, vessels for transporting assembled units and servicing installed units, and integrating and interconnecting the units to the onshore electric power grid.

#### *Port Facility Requirements*

The U.S. wind industry is still in its infancy. Offshore wind energy projects require specialized equipment, services, and labor expertise for construction and servicing, much of which does not yet exist. These capabilities are likely to develop based on lessons learned from the European offshore wind industry and by leveraging existing marine industries.

---

<sup>37</sup> Hawai‘i Clean Energy Final Programmatic Environmental Impact Statement Summary, U.S. Department of Energy, Office of Electricity Delivery and Energy Reliability, Office of Energy Efficiency and Renewable Energy, DOE/EIS-0459, September 2015.

Offshore wind construction and operation require specialized port facilities that can host fabrication and assembly of platform and turbines, staging for and the installation of the platforms and turbines at the project site, and ongoing operation and maintenance activities. BOEM recently commissioned a study that addresses the status and needs of port facilities to support an offshore wind and hydrokinetic energy industry in the Pacific Region of the United States, including Hawai‘i.<sup>38</sup> This report identified the following three major functions that one or more ports must provide to support offshore wind.

**Quick Reaction Port:** This includes pre-installation surveys and transfer of construction and maintenance crews to the wind platform site.

**Fabrication and Construction Port:** This function essentially fulfills the need for a transportation hub for all of the components (wind turbines, platforms, cables, and related components); for fabrication of device components; and for construction, staging, and pre-assembly of device components.

**Assembly Port:** This function provides the ability to assemble the floating platforms and turbines in port for towing to the project site.

In its BOEM Lease Application, Progression Energy states that the minimum requirements for a port that can support its project include:

- Access channel depth of at least 10 meters (32 feet).
- Minimum berthing frontage of 250–300 meters (820–984 feet).
- Quayside bearing capacity of approximately 9,071 kilograms/m<sup>2</sup> (10 tons).
- 20–30 acres of available staging areas and reliable access to intermodal transfer facilities.
- U.S. Government support offices in the vicinity.

Progression did not identify any specific available port facilities in Hawai‘i that could meet these minimum requirements.

The BOEM 2016-034 report provides an extensive assessment of Hawai‘i port facilities and their suitability to support floating platform wind development and operation. Based on its assessment of the port facilities, the BOEM 2016-034 report identified “potential gaps” related to port facilities in Hawai‘i for supporting an offshore wind industry in the State.

---

<sup>38</sup> *Determining the Infrastructure Needs to Support Offshore Floating Wind and Marine Hydrokinetic Facilities on the Pacific West Coast and Hawai‘i.* (OCS Study, BOEM 2016-011, March 3, 2016.)

## H. Renewable Resource Options for O‘ahu

### Offshore Floating Platform Wind Energy

These gaps include:

- Additional upland area with marine access would be needed to fully support fabrication requirements.
- Turbine components will likely be imported because of the lack of availability of land for fabrication and construction of turbines.
- The berth-specific bearing capacity in specific ports is unknown at this time.
- Assembly of the semi-submersible floating platforms will require major land redevelopment in any of the Hawai‘i port areas.
- There is limited redundancy among potential port locations.
- Harbor depths preclude assembly of the offshore wind spar buoys (assuming a spar buoy platform design) with existing technology.

In Hawai‘i, the ports of interest to the offshore wind industry are managed by the State of Hawai‘i Department of Transportation, Harbors Division. The most likely Hawai‘i port for support of an offshore wind industry in Hawai‘i is Kalaeloa Barbers Point.<sup>39</sup> The Harbors Division has indicated the following:<sup>40</sup>

- The current port facilities at Kalaeloa Barbers Point are congested with multiple competing uses for routine importation of commodities such as lumber, cement, and asphalt.
- There is a plan to add berthing space to relieve this congestion, but this plan is in response to additional demand from either existing users, or new users other than the offshore wind industry. The Harbors Division completed a Master Plan for 2040 for Kalaeloa Barbers Point Harbor in 2015. The Master Plan process, however, did not receive any input from offshore wind interests, and therefore it did not consider the possibility of offshore wind assembly or fabrication.
- Improvements of ports in the State of Hawai‘i usually happen after an EIS has been prepared. Revenue bonds are used to finance the improvements, however they cannot be issued for funding improvements that would only benefit a single user.
- There are inland areas around the Kalaeloa port that could be expanded. However, there is strong demand for this space from interests that would consider long-term leases (for example, 20 plus years). In contrast, offshore wind developers would only commit to much shorter term (for example, three years) leases. This sets up a policy decision by the State for deciding among competing uses of the limited area in existing ports, even if such ports are expanded.

<sup>39</sup> Telephone conversation with Dean Watase, Senior Planner, Department of Transportation, Harbors Division.

<sup>40</sup> *Ibid.*

- Due to the proximity to airports, assembly and erection of floating wind platforms, with towers and turbines as tall as 700 feet, would violate current FAA height restrictions at both Kalaeloa Barbers Point and Honolulu harbors.

As such, there are significant challenges for any developer wishing to utilize the few, already constrained ports in the State of Hawai'i for fabricating and assembling floating platform wind turbines. While these challenges might be overcome, significant resources will be required (time and money) and political decisions will have to be made. In particular, the time it will take to complete these modifications calls into question the ability to meet the aggressive schedules proposed by Alpha and Progression.

### *Vessels*

A variety of vessels will be required to construct and service offshore wind facilities.

Anchor handling tugs and service vessels, Offshore wind service vessels, crew transfer vessels, service vessels are typically not found on the west coast or in Hawai'i and would probably need to be purpose built to meet the high swell conditions in the Pacific Ocean. The first U.S. fleet of crew transfer vessels is being developed at the present time to service the Block Island Wind Project off of Rhode Island.

Ships for laying power cables are highly specialized vessels typically owned and mobilized by a cable manufacturer / installer such as Prysmian and ABB. There are presently very few ships in the world that can lay undersea power cables. While the existing ships can be made available in Hawai'i, the scheduling of these vessels can involve scheduling lead times of two to three years. High demand for undersea power cables for HVDC interconnections, and for the burgeoning demand related to the offshore wind industry in the United States, could lead to additional cable laying vessels being commissioned over the next few years.

### *Interconnection and Integration with the O'ahu Grid*

Interconnection and transmission integration issues for offshore wind projects serving the O'ahu grid have not been studied in detail. The interconnection and integration infrastructure, and its cost, depends on a number of factors: the specific point of interconnection, existing transmission infrastructure, thermal generation deactivations, and new generation installations between now and the in-service date of the offshore wind project.

There will likely be a capital cost associated with accommodating an interconnection of this magnitude. Most certainly, substantial upgrades will be required at the point of interconnection. In addition, depending on the configuration of the power system at the time of interconnection, substantial transmission upgrades, or even new transmission, could be required to accommodate the injection of a substantial amount of power at one or two points of interconnection.



## H. Renewable Resource Options for O‘ahu

### Offshore Floating Platform Wind Energy

Integrating offshore wind into the O‘ahu grid is also an issue. Consider:

- The largest single unit contingency in the O‘ahu system is presently 180 MW (the AES Hawai‘i coal power plant). Increasing the largest single unit contingency has operating cost ramifications related to the amount of “spinning” reserve required to maintain the reliability of the O‘ahu power system. This may result in the necessity to divide a single 400 MW project into two separate groups for interconnection.
- As of today, the peak demand on O‘ahu (net of customer owned generation) is approximately 1,200 MW. A 400 MW wind facility operating at system peak would be supplying about one-third of O‘ahu load. The minimum system load (net of customer owned generation) is approximately 500 MW. A 400 MW wind facility operating at the minimum load hour would be supplying 80% of the O‘ahu load, leaving little room for must-run or firm, dispatchable resources to operate (renewable or otherwise).
- The total system net energy requirement on the O‘ahu system (including line losses, but excluding customer generation) is approximately 6,500 GWh per year (net of energy efficiency and distributed generation).<sup>41</sup> Therefore, a 400 MW offshore wind project with an annual capacity factor of 60% would provide approximately one-third of the total energy requirements for O‘ahu. With other renewable resources in the resource mix (including must-take DER resources), this will likely require either curtailment of renewable resources or energy storage to better match generation with demand.

Utilizing wind energy from a single project might increase the total cost of providing ancillary services necessary for the grid to remain reliable, result in a concentration (that is, a less diversified portfolio) of renewable resources to meet Hawai‘i’s clean energy goals, and reduce the flexibility to accommodate other renewable resource options, including both grid-scale and DER options (although this is an economic and policy issue).

---

<sup>41</sup> *PSIP Update Report: April 2016, op. cit., Appendix J, Table J-10, page J-44.*

## Development Timetable

A conceptual timetable illustrating the time necessary for developing offshore wind reveals that, from today, a period of at least seven years will likely be required until commercial operation in Hawai‘i.

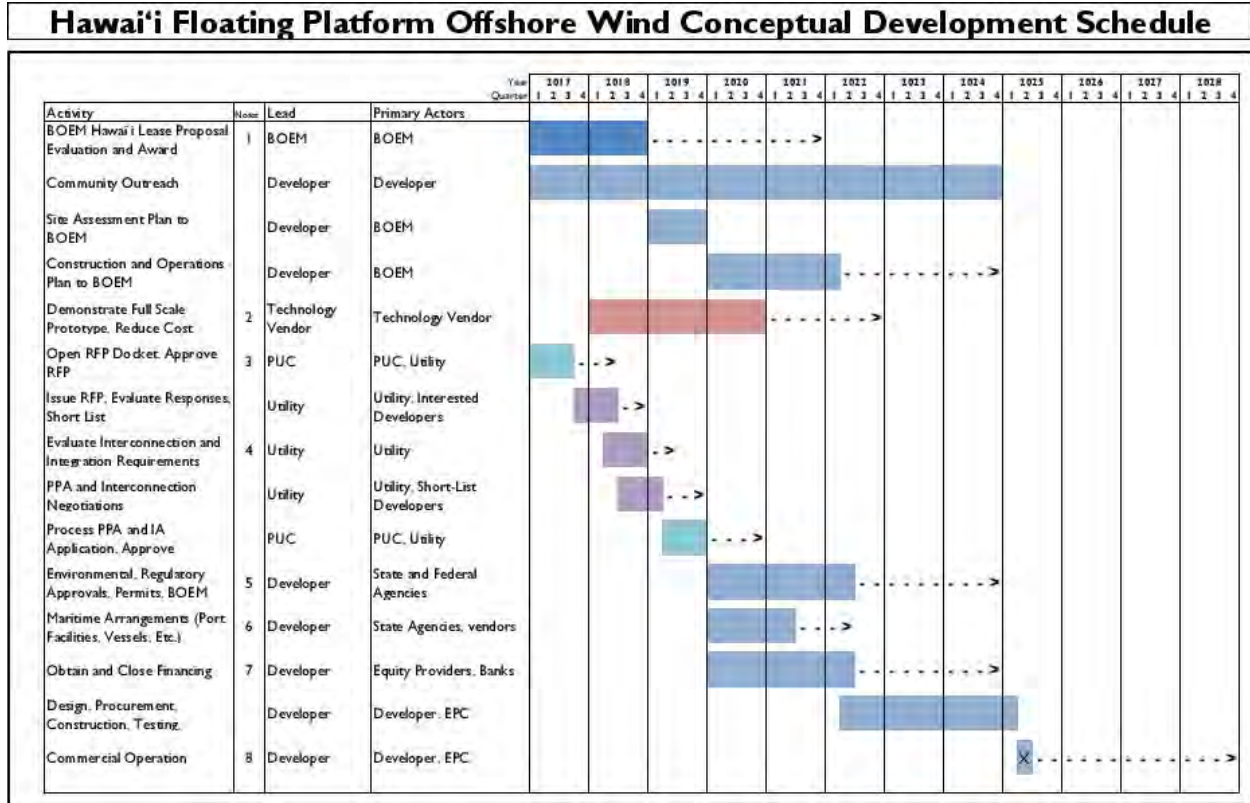

Notes: A dotted line with arrow (--->) denotes an area of significant schedule risk. The overall schedule impact is not shown.

- 1 BOEM has issued a call for lease proposals; indicated the process could take as long as five years.
- 2 Principle Power WindFloat scheduled for full scale prototype deployment in 2018.
- 3 Hawaiian Electric has filed a letter with the Hawai‘i Public Utilities Commission requesting to open an RFP docket.
- 4 Interconnection issues for injection of 400+ MW of offshore wind into the O‘ahu system are likely to be substantial.
- 5 This includes legislative actions and, if required, DOD approvals. It does not include litigation costs after permits are issued.
- 6 Arrangements for use of local port facilities and appropriate vessels. Mainland fabrication is likely to add capital cost.
- 7 Financing is dependent on full scale prototype success, backing of technology performance by large balance sheet EPC, and the ability to ensure the project and acceptable O&M arrangements.
- 8 Earliest likely commercial operation date. The schedule risk is driven by other activities.

Figure H-17. Conceptual Development Timeline for Offshore Floating Platform Wind in Hawai‘i

### Key Findings

Several key findings emerge from our analysis of offshore floating platform wind energy.

1. Offshore wind technology is still in the development phase and will likely not be commercially available until at least the early 2020s.
2. The capital cost of offshore floating platform wind is forecasted to decrease as the technology becomes more mature. Developer estimates for installation in Hawai‘i in the early 2020s appear to be too optimistic.
3. The BOEM process is defined. However, there are a multitude of additional agencies at the State and Federal levels that need to approve any offshore wind project in Hawai‘i.
4. The BOEM leasing process will likely take several years.
5. The availability of local ports is constrained, which might impact schedule and costs of offshore wind in Hawai‘i. Competing uses for port facilities might become a significant hurdle to constructing offshore wind platforms in Hawai‘i.
6. Developing offshore wind projects requires a system of undersea, alternating current, power cables. Floating substations are envisioned for the Hawai‘i offshore wind projects; there is currently little experience with floating substations.

### Conclusions

Our assessment of offshore floating platform wind energy results in these conclusions.

1. It is unlikely that either Progression Energy or Alpha Wind can successfully develop an offshore wind platform in the time frames they have publicly claimed.
2. Offshore floating platform wind will likely become a commercially available technology during Hawai‘i’s energy planning horizon.
3. 2030 is a reasonable point in time during the planning horizon to include offshore floating platform wind as a renewable resource option available for installation in Hawai‘i.
4. The viability of offshore floating platform wind as a renewable resource option for Hawai‘i will depend on political and community acceptance, overcoming siting issues (including siting and routing of undersea alternating current power cables), and a decline in capital cost to economically feasible levels.

---

## INTERISLAND TRANSMISSION

Interisland transmission cables, while technically feasible, must be considered on economics and policy.

Part of the answer to those considerations is to determine the ultimate purpose of interisland transmission. Interconnecting various island, always including O‘ahu, could result in lower overall operating costs. This is purely a financial analysis: do the benefits outweigh the costs. Interisland transmission also might be necessary to achieve the 100% renewable generation mandate.

### Technically Feasible

The technology to construct and operate interisland transmission cables is technically mature, commercially available with operating installations around the world, and financially feasible in capital markets. Such cables have been shown to have a very high level of reliability.

Because of the distances, high voltage direct current (HVDC) technology is being used for interconnecting the islands of O‘ahu, Maui, and Hawai‘i, including converter stations on either end of a submarine cable. Submarine HVDC systems have been successfully deployed around the world; the market for HVDC systems is expected to dramatically increase in the future.<sup>42</sup>

There are relatively few vendors of HVDC technology. Active vendors are global players with large balance sheets with the ability to support this technology. HVDC systems exhibit a high level of reliability and are highly controllable, providing flexibility for providing grid services.

Cost estimates for interisland transmission cables range from connecting remote resources (such as wind developed on one island specifically to serve another island) to connecting two or more of our island grids for joint dispatch. Costs for HVDC projects are typically developed with the vendor providing turnkey engineering procurement construction (EPC) with guaranteed prices (subject to sliding cost categories related to commodity prices), guaranteed schedules, and guaranteed performance.

Potential vendors are unlikely to develop accurate costs for a specific interisland cable configuration unless they can be assured that the project has a high likelihood of development. Absent that assurance, a qualified party could be engaged, for a fee, to

---

<sup>42</sup> <http://www.marketsandmarkets.com/Market-Reports/hvdc-grid-market-1225.html>.

## H. Renewable Resource Options for O‘ahu

### Interisland Transmission

study, assess, and develop a comprehensive cost estimate. Currently, our lowest known capital cost estimate for a single 200 MW interisland transmission cable between O‘ahu and Maui is approximately \$600 million.<sup>43</sup> The capital cost for multiple cables with higher capacities will be significantly higher.

Developing an interisland cable in Hawai‘i also faces a number of development challenges including: siting onshore infrastructure (for example, HVDC converter stations), integrating a cable with the existing power systems on connected islands, mitigating the impacts on marine mammals, avoiding deep sea corals, avoiding disturbances at archeological sites near coastal cable landing zones, permitting hurdles, cultural and social issues, among others. Many of these issues are shared with offshore wind, which also requires a system of undersea cables, but adds the complication of developing resources on one island to be used by another island.

Essentially, the decision to install interisland transmission cables is driven by two factors: economics: do the benefits outweigh the costs; and policy: do the benefits accede to social acceptance and political will.

Interisland transmission, if installed, also changes the underlying electric power structure from individually separated island grids to interconnected grids – for decades. The lifespan of HVDC cables approaches 40 years.

## Policy Issues

Proposals for undersea cables to provide O‘ahu access to energy resources located on other islands have been around since at least 1881, when King David Kalākaua visited Thomas Edison in his New York Laboratory.<sup>44</sup>

A substantial issue, thus, is the ability to actually develop renewable resources on the islands interconnected to O‘ahu. The public has expressed concern regarding development of wind projects in Maui County particularly if the power is intended for consumption on O‘ahu. Similarly, there has been expressed public concern to development of additional geothermal resources on Hawai‘i Island. Proposals were made to build 200 MW of wind power on Moloka‘i and 200 MW of wind power on Lana‘i for transmission to O‘ahu.

<sup>43</sup> NextEra Energy developed and filed the \$600 million estimate in Docket No. 2014-0169. (NextEra has since withdrawn from that proceeding.) This amount is at the low end of the \$553–\$969 million estimated range filed in our 2013 Integrated Resource Plan Report, Appendix H: Inter-Island Transmission Costs, for the capital cost of connecting O‘ahu with Maui to transmit 200 MW of energy with a HVDC non-redundant cable. NextEra’s estimate, however, is well below that adjusted-for-inflation \$760 million to \$1.24 Billion range that included permitting and other development costs such as land acquisition. In addition, it’s unclear whether NextEra’s cost estimate includes the transmission system improvements and upgrades necessary to interconnect O‘ahu and Maui.

<sup>44</sup> <http://hawaiiankingdom.org/blog/kalakaua-visits-edison-the-king-in-search-of-a-means-to-light-up-honolulu/>.

First Wind, and later Pattern Energy, withdrew from pursuing the Moloka‘i wind project. Castle & Cooke sold its interest in real estate on Lana‘i to Larry Ellison, but retained the rights to construct a wind project on Lana‘i. However, the status of Castle & Cooke’s continued plans for wind development on Lana‘i is unknown.

In 2013, the Hawai‘i Public Utilities Commission opened Docket 2013-0169 for the purpose of determining if interisland cables were in the public interest. After two rounds of comments from interested parties early in the life of that proceeding, Docket 2013-0169 has largely been inactive.

In April 2014, the Commission instructed the Companies to evaluate the feasibility of interisland cables<sup>45</sup> as part of the PSIP process. The Commission did not specify what purpose an interisland cable might serve, and therefore left it to the Companies to make that determination. Our 2014 PSIPs included an economic evaluation of interconnecting the O‘ahu and Maui power systems to achieve savings through joint dispatch. We found, however, that the gross benefits of such an interconnection was substantially less than the estimated cost of a cable. Thus, we concluded that interconnection solely for dispatch benefits was not economically feasible.

In Order No. 33320, the Commission ordered the Companies to further evaluate the feasibility of interisland transmission, particularly given the 100% RPS goal set forth in Act 97. Our 2016 updated PSIP analyzed the feasibility of interisland transmission, which focused on determining if there is an optimal plan for achieving Hawai‘i’s overall RPS goals through island interconnection compared to optimizing each island separately.

Rather than developing an accurate capital cost, we decided to first analyze the *benefits* of interisland transmission to determine if the sum total of such benefits could reasonably exceed this approximated cost. This break-even analysis assumes various “copper plate” configurations: assume one or more cables transfers power between two or more points, without consideration of reliability (that is, the need for redundant cables); comparing the benefits against \$600 million; and if benefits exceed cost, then conduct further analysis. For example, cumulative benefits of interconnecting O‘ahu and Maui<sup>46</sup> that approach \$600 million would warrant more detailed analysis.

---

<sup>45</sup> Decision and Order No. 32052, Docket No. 2012-0036.

<sup>46</sup> For perspective, our 2014 PSIPs showed a maximum benefit of approximately \$300 million the so-called “copper plate” configuration for and interconnection between O‘ahu and Maui (net present value gross savings)—about half the lowest estimated cost of \$600 million.

## H. Renewable Resource Options for O‘ahu

### Interisland Transmission

This additional analysis would include:

- Identifying the on-island transmission system upgrades required to interconnect the interisland cable, including an analysis of prospective interconnection points.
- Analyzing reliability and system security to determine the issues associated with operating an interisland cable.
- Retaining a third-party qualified to develop a detailed cost estimate for installing an interisland cable and a preliminary list of issues necessary for obtaining permits and approvals.

The benefits of interisland transmission are part of developing this December 2016 PSIP.

Our goal is to determine, as quickly as possible, whether or not interisland transmission represents a viable resource option for Hawai‘i that demands further analysis. We believe this two-step process – first evaluating the benefits, then, if warranted, evaluating the cost – is the most prudent, cost effective, and timely way to determine if interisland transmission demand further consideration as an option to pursue to help achieve our State’s renewable energy goals. Regardless, interisland transmission will require many years to develop, and as such, will not have an impact on our near-term action plans.

## HYDROKINETIC ENERGY

Hydrokinetic energy captures the energy from flowing water that occurs in rivers and mostly in ocean currents. This technology includes:

- Tidal barrage
- Tidal stream (and river in-stream energy)
- Ocean current
- Ocean wave
- Ocean thermal conversion
- Salinity gradient

The latent potential for hydrokinetic energy is, to put it mildly, extraordinary. Table H-10 compares the potential contribution that the various hydrokinetic energy technologies toward attaining the current worldwide energy production of 17,400 terawatt hours per year. Further, power from the ocean is relatively predictable, mostly firm generation. The overall potential, if ever realized, would easily generate enough energy to power the entire world, and could power over five times that amount.

Hydrokinetic Technology	Estimated Global Resources (TWh per year)	Percentage of Current Global Electricity Production
Tidal Barrage	300+	1.7%
Tidal Stream	800	4.6%
Ocean Wave	8,000–80,000	46%–460%
Ocean Thermal	10,000	57.5%
Salinity Gradients	2,000	11.5%
Totals	21,100–93,100	121.3%–535.3%

Table H-10. Hydrokinetic Energy Global Electricity Production Percentages

While hydrokinetic energy has incredible potential, none of these technologies are close to being commercially ready and would take decades to be realized. While a fair number of pilot and experimental projects are being implemented worldwide, their potential is essentially untapped. Notice that the ocean current technology is missing from Table H-10, mainly because it's merely conceptual.



## H. Renewable Resource Options for O‘ahu

### Hydrokinetic Energy

A report by The International Renewable Energy Agency (IRENA) described the six basic hydrokinetic technologies, and their related readiness and potential, which are summarized in Table H-11.<sup>47</sup>

Technology	TRL*	Readiness	Description	Conditions for Deployment	Hawai‘i Potential
Tidal Barrage (Tidal Range)	9	Commercial, but few projects developed.	Based on conventional hydropower technology. Impoundment of water near shore with tide filling the reservoir.	Large daily tidal fluctuations; very specific site characteristics.	Low
Tidal Stream	7–8	Prototype testing in field environments.	Capture tidal flow through constrained topography (for example, channels, bays, harbors) via underwater turbines.	High tidal fluctuations; specific geological features.	Low
Ocean Wave	6	Pre-commercial prototypes with commercialization goals for the “next decade”.	Various concepts for capturing energy from waves.	Best potential between latitudes of 30° and 60°.	Medium
Ocean Thermal	5-6	Pilot-scale test facilities, but no long term operation.	Utilizes temperature differentials between surface and deep water in a Rankine Cycle, with special working fluid.	Best potential between latitudes of 0° and 30°.	High
Ocean Current	4-5	Conceptual. No prototypes ever tested or demonstrated.	Capture energy from major ocean currents (open ocean) via underwater turbines.	Energy demand in proximity to major ocean currents.	High
Salinity Gradient	4	Conceptual.	Harnesses the chemical potential energy between fresh water and salt water	Distributed globally. Best areas where rivers meet the ocean.	Low

\* See Table H-7 for a description of the Technical Readiness Levels

Table H-11. Hydrokinetic Technologies Readiness and Potential

For Hawai‘i, the recoverable energy potential from wave power alone has been estimated to be about 80 terawatt-hours per year,<sup>48</sup> roughly equal to the state’s annual energy demand across all fuels (that is, electricity, gasoline, jet fuel, and others).<sup>49</sup>

When available, implementing certain hydrokinetic technologies would require addressing many of the same issues highlighted for offshore floating platform wind: siting, permitting, port facilities, competing uses of the ocean resources, and others. While the promise of extracting usable energy from the ocean is worthy of pursuit by researchers and technology developers, no “off-the-shelf” technology is available today

<sup>47</sup> *Ocean Energy Technology Readiness, Patents, Deployment Status and Outlook*, IRENA, August 2014, at xi; available at: [http://www.irena.org/DocumentDownloads/Publications/IRENA\\_Ocean\\_Energy\\_report\\_2014.pdf](http://www.irena.org/DocumentDownloads/Publications/IRENA_Ocean_Energy_report_2014.pdf).

<sup>48</sup> <http://www.boem.gov/Ocean-Wave-Energy/>.

<sup>49</sup> According to the Energy Information Administration, total energy demand in Hawai‘i in 2014 was 281.2 trillion Btu’s. [http://www.eia.gov/state/seds/data.cfm?incfile=/state/seds/sep\\_sum/html/rank\\_use\\_gdp.html](http://www.eia.gov/state/seds/data.cfm?incfile=/state/seds/sep_sum/html/rank_use_gdp.html). Conversion of Btu to kWh at a rate of 0.000293071 kWh/Btu yields an equivalent of 82.4 terawatt-hours.

for Hawai'i that can generate power in meaningful quantities. Based on current condition, several more decades might pass before such technologies achieve commercial viability.<sup>50</sup>

Even though it's impossible to predict the future commercial availability, cost, and performance characteristics of hydrokinetic technologies for Hawai'i; the chance that one or more of these hydrokinetic technologies becomes viable within our near-term action plan is highly implausible. Because of this, we did not consider these technologies in our resource planning. When such technologies are commercially available and can readily be financed, they could become viable options to replace power supply options such as wind, solar PV, geothermal, biomass, and other renewable resources.

## Tidal Barrage

Tidal barrage employs the vertical difference between high and low tides. It requires 10 meters of vertical difference between the ebb and flood of tides. The technology is similar to conventional hydroelectric dams.

There is both ebb generation and flood generation. For ebb generation: while the tide is rising, the reservoir behind the dam is filled with water through open sluices while the turbine gate is closed. When high tide is reached, the sluices shut. When the ocean level has receded to sufficiently low levels, the turbine gate opens and the water from the reservoir is channeled onto the turbine, thus generating electricity. For flood generation: while the tide is rising, water flows through the turbine into the reservoir, generating electricity during the flood. Ebb generation is more efficient than flood generation.

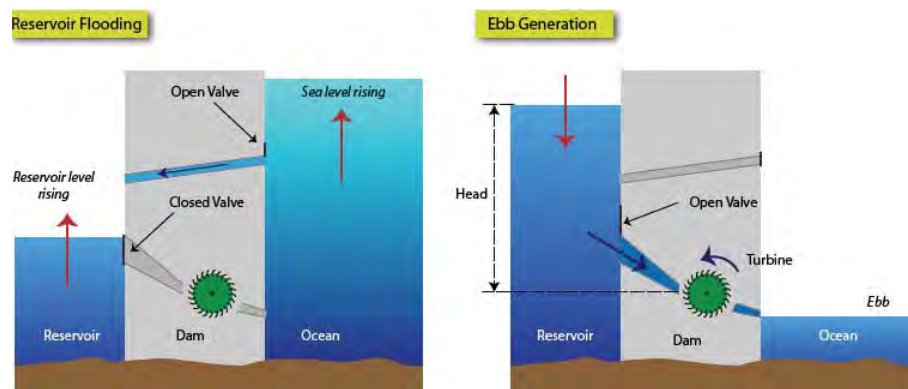

Figure H-18. Tidal Range Reservoir Flooding and Ebb Generation

<sup>50</sup> See: [http://e360.yale.edu/feature/why\\_wave\\_power\\_has\\_lagged\\_far\\_behind\\_as\\_energy\\_source/2760/](http://e360.yale.edu/feature/why_wave_power_has_lagged_far_behind_as_energy_source/2760/) and [http://e360.yale.edu/feature/will\\_tidal\\_and\\_wave\\_energy\\_ever\\_live\\_up\\_to\\_their\\_potential/2920/](http://e360.yale.edu/feature/will_tidal_and_wave_energy_ever_live_up_to_their_potential/2920/).

## H. Renewable Resource Options for O‘ahu

### Hydrokinetic Energy

While the potential for tidal barrage is huge, there are only 50 sites worldwide in six regions for implementation: the Bay of Fundy, Canada (with up to 12 meters mean tide); Bristol Channel and Cardiff Bay, United Kingdom; Normandy, France; Magellan Strait, Argentina and Chile; Cook Inlet, Alaska; and Penzhinskaya Bay, Kamtchatka, Russia. In addition, environmental concerns have limited expansion. No sites have been identified in Hawai‘i.

Only two sites worldwide are currently operating. The La Rance estuary plant in France (operating since 1966) generates 240 MW while the Bay of Fundy facility generates 8 MW. Both South Korea and China are currently building tidal barrage facilities. Russia is in the planning stages of building an enormous 87 GW tidal barrage facility in Kamtchatka.

### Tidal Stream

Tidal stream turbines exploit the kinetic energy from the water flowing in and out, in both ocean and river sites. Good sites have flow speeds of more than four meters per second in 40 meter depth. The technologies are similar to wind turbines. Apart from tidal barrages, tidal stream is the most developed marine technology with some projects on the brink of going commercial. Its low environmental impact favors tidal stream over tidal barrage.

Ocean Renewable Power Company (ORPC) installed their TidGen tidal generator turbine (Figure H-19) in Cobscook Bay in Eastport, Maine. TidGen is expected to increase the size of the generator to 5 MW gross, and maintain that for the length of their 20-year PPA.



Figure H-19. ORPC TidGen Tidal Generator

ORPC also installed their RivGen river generator turbine in the Kvichak River, adjacent to Igiugig, Alaska. On August 31, 2016, the U.S. Department of Energy awarded \$5,350,000 to ORPC to enhance the performance of its tidal turbine system.



Figure H-20. ORPC RivGen Generator

## Ocean Wave

Wave height and wave period (for horizontal speed) is used to generate energy. Typical wave height is 3 meters; its wave period is eight second. Because of these two types of wave energy, conversion is complex. As a result, technologies are also complex and sited far offshore for the best wave consistency.

Successful demonstration wave power projects have been implemented in several locations around the world, including Hawai‘i. Small grid-scale wave energy projects have been installed in Europe (such as the one depicted in Figure H-21).



Figure H-21. Pelamis Wave Energy Converter at the European Marine Energy Test Centre, 2008

## H. Renewable Resource Options for O‘ahu

### Hydrokinetic Energy

Carnegie Wave Energy is undertaking the design, construction, installation, and demonstration of a grid-connected wave generation project with up to 3 MW peak installed capacity off Garden Island, Western Australia. The project will deploy three grid-connected of the company’s CETO 6 units.



Figure H-22. CETO 6 Wave Energy Oscillating Buoy

The CETO 6 buoy oscillates with the ocean’s waves, transferring energy to a power conversion unit located inside the buoy, generating power offshore and transmitting it onshore via a subsea cable. The Australian Department of Defense intends to purchase the power generated by the project, which will provide electricity for HMAS Stirling, Australia’s largest naval base.

Closer to home, we currently partner with the U.S. Navy (and others) in a small-scale pilot. On September 18, 2016, the first wave-produced electricity went online in Kaneohe Bay on O‘ahu. The project consists of two buoys that each capture the ocean’s movement and convert it into electricity. One buoy produces 18 kilowatts of energy; the other produces 4 kilowatts. According to published reports, wave energy technology is at about the same stage as the solar and wind industries were in the 1980s.

## Ocean Thermal Energy Conversion

The temperature difference between surface and deep water can be used to drive a turbine. Warm surface water vaporizes an expanding gas that drives a turbine. Cold, deep ocean water cools the gas to a liquid, which is pumped back to the vaporizer.

Hawai‘i is a pioneer in ocean thermal energy conversion (OTEC) research, having demonstrated the first successful OTEC project on Hawai‘i Island in the 1970s. Currently, there are two ocean energy projects installations in Hawai‘i, both the first of their kind to be connected to a United States grid. In August 2015, Hawai‘i’s Makai Ocean Engineering completed the world’s largest operational OTEC power plant at its facility in Kona on Hawai‘i Island.



Figure H-23. Makai OTEC Generator

The OTEC power plant uses the temperature difference between the near-freezing deep water of the ocean and the surface waters heated by the sun to generate electricity. The plant produces 100 kilowatts of energy. In addition, a 1 MW OTEC plant is planned for the Hawai‘i Ocean Science and Technology Park in Kailua-Kona on Hawai‘i Island. Unfortunately, OTEC International (OTECI), which had proposed a 100 MW OTEC project to serve O‘ahu, announced that it was withdrawing from the Hawai‘i market.<sup>51</sup>

Although the thermal energy stored in oceans is huge, the low temperature difference of 20°C over a length of one kilometer makes it very difficult to exploit. Despite the technological promise of OTEC for large-scale electricity generation, no full-scale OTEC plant has yet to be built anywhere in the world; and the prospects appear decades away.

<sup>51</sup> <http://www.utilitydive.com/news/heco-developer-shelve-100-mw-ocean-thermal-energy-project-off-hawaii/401000/>.

## H. Renewable Resource Options for O'ahu

### Hydrokinetic Energy

#### Salinity Gradient

The salinity gradients between the natural mixing of fresh and salt water provides large amounts of energy, which this technologies aims to capture. Originally discovered in the 1970s, research has been slow and most of it recent. Research focuses on two practical methods: the reverse electrodialysis (RED) method and pressure retarded osmosis (PRO). Both technologies are dependent on selective semi permeable, ion-specific membranes (that is, only specific substances can pass through the membrane).

Siting is very location specific, although there are a large number of possibilities. While the majority of components required for a salinity gradient power have reached commercialization, the technology is still in its infancy. No salinity gradient power plants – conceptual, pilot, or functional – have been built anywhere in the world.

#### Commercial Prospects

Hydrokinetic power exhibits similar development challenges as offshore floating platform wind: siting, permitting, and financing. Implementing large-scale tidal and wave installations has thus far been hampered by a lack of understanding of the associated siting and permitting challenges in multiple jurisdictions. Wave and tidal power projects may face similar interconnection challenges as offshore wind.

The uncertainty and long time frames associated with achieving technology readiness and commercial availability of hydrokinetic energy suggest that this technology should not be considered an available renewable energy resource during the current PSIP planning cycle. Commercialization of hydrokinetic technologies is likely at least two, if not three, decades away. Success of the floating platform wind energy industry, however, could pave the way for these ocean technologies as they are perfected.

Should this technology become commercially viable in a large scale and demonstrate the ability to be financed without substantial subsidies, we will reconsider including wave and tidal power as a resource option in future resource plans.

# I. Financial Analyses and Bill Impact Calculations

In our analyses, the Companies developed alternative approaches to achieve 100% RPS, analyzed the differentials between cases, and prepared comprehensive total customer bill impact and rate analyses. These results are described in Chapter 5: Financial Impacts.

Preparing comprehensive bill impact and rate analyses for a nearly 30-year planning period is an unusual level of financial planning and projections in the industry. While the Resource Plans provide the expected fuel cost, operating costs, and capital investments for critical resources given our resource cost assumptions and fuel price forecasts, the capital investments and operating expenses for the balance of our utility business needs to be projected and incorporated into the comprehensive bill impact and rate analyses; in other words, our non-power supply costs.

To meet this challenge, we developed a top-down methodology to project this “balance-of-utility business” capital and expense requirements.

---

## ITERATIVE TOP-DOWN METHODOLOGY

Our non-power supply cost structure—and correspondingly its revenue requirement and customer bills in total—comprise four primary elements.

- Operating & maintenance costs.
- Taxes other than income and public benefits fund.
- Return on and of existing utility asset investments.
- Return on and of future utility asset investments, net of productivity savings.



## I. Financial Analyses and Bill Impact Calculations

### Iterative Top-Down Methodology

We integrate the non-power supply cost structure with the power supply forecast to develop a holistic plan by operating utility. We then apply a financing capacity test and a rate change test and make adjustments as needed to ensure the results are within acceptable ranges.

### Financing Capacity Test

We currently have a limit to the amount of new capital expenditures we can finance on terms acceptable to both customers and shareholders. There is a ceiling on the total capital expenditures of the consolidate plan in a given year or period of years.

The annual capital expenditures of the power supply plans and the future annual capital expenditures for the balance of the business are summed by year to determine if the total capital expenditures are within the Companies' financing capacity. Projected capital expenditures for both the power supply plans and the balance of the utility business are evaluated for operational needs along with the need to stay within the Companies' financing capacity. The adjusted capital expenditure plan is then used for the customer bill and rate impact analyses.

### Rate Change Test

There are also economic and policy limitations to levels of future changes in customer bills and rates. While the science of these limits maybe somewhat less precise than the financing capacity limits discussed above, these limits are real and constraining.

To determine an annual rate change test limitation for each operating utility against which to test the plans, three different approaches to project annual rate changes were considered. These are:

- Rates adjust at the rate of inflation.
- Rates adjust at a blended rate, reflecting fuel price forecasts<sup>1</sup> and general inflation for "business as usual"<sup>2</sup> operations.
- Rates adjust at the rate of price change over the prior decade.

These approaches, when applied to each operating utility, result in the following annual rate change scenarios (shown in Figure I-1 through Figure I-3).

---

<sup>1</sup> The fuel price component of these rate trajectories have been adjusted to reflect fuel blending required to meet environmental regulations.

<sup>2</sup> "Business as usual" in this context means continued use of the existing generating portfolio and fuel types, consistent with environmental regulations.

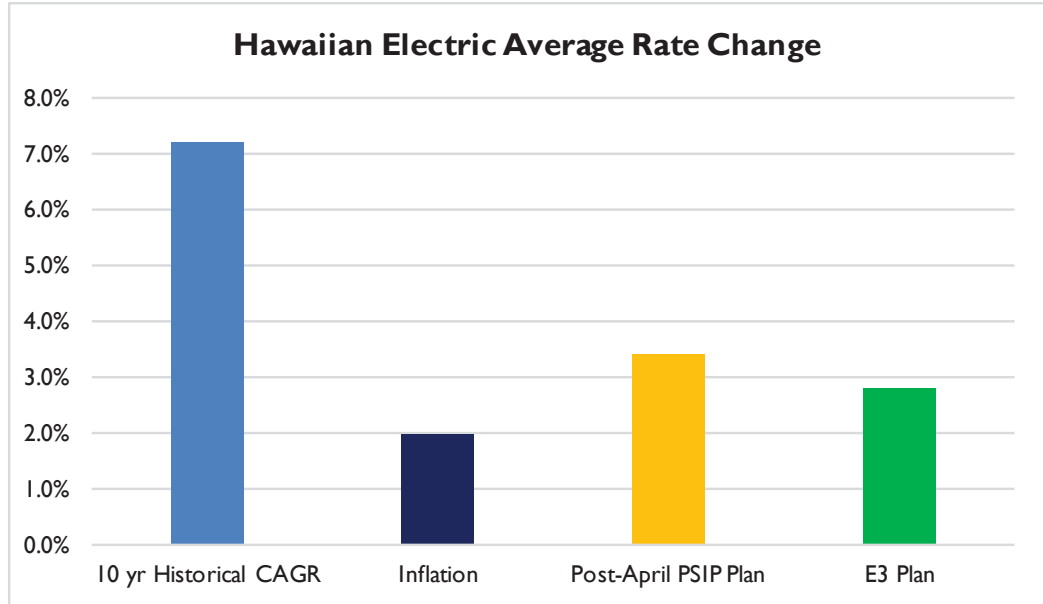

Figure I-1. Hawaiian Electric Average Rate Change

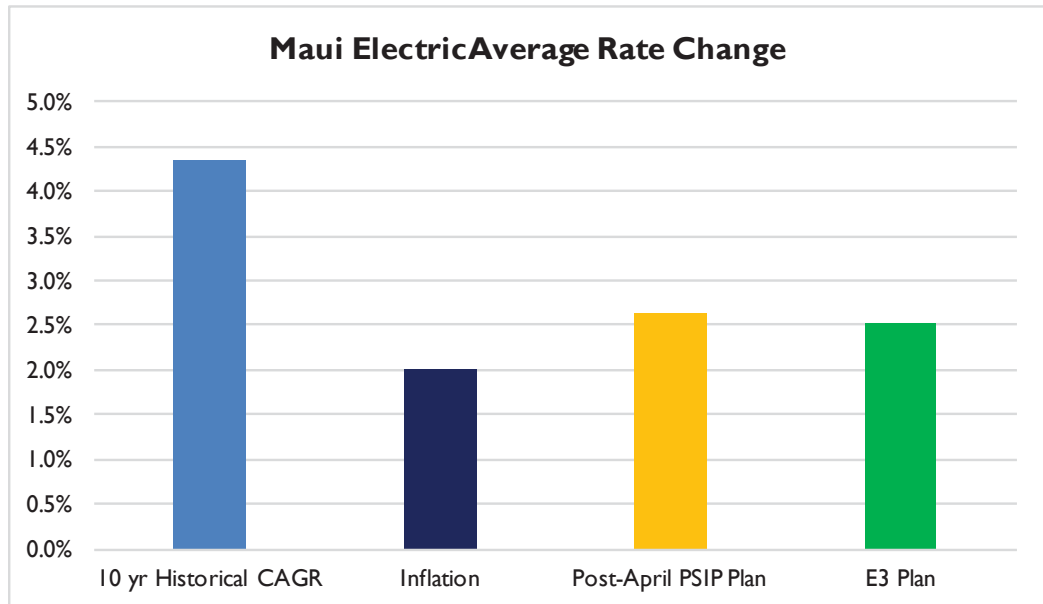

Figure I-2. Maui Electric Average Rate Change

## I. Financial Analyses and Bill Impact Calculations

Iterative Top-Down Methodology

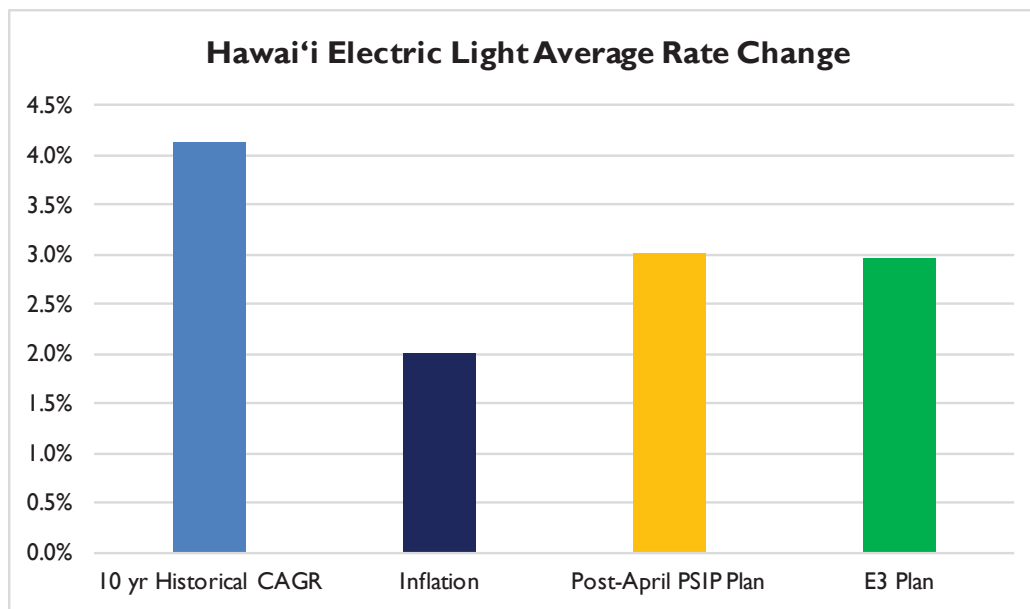

Figure I-3. Hawai'i Electric Light Average Rate Change

In addition to these annual rate change data points, we understand that there is a price point beyond which customers have economically feasible alternatives to grid supply. While there are many quantitative and qualitative factors that go into such a decision, we know that we must deliver to our customers an attractive total value proposition of affordability, reliability, and convenience. Based on these analyses, we targeted an annual rate change ceiling of 4%, with exceptions made in certain years for implementation of significant major capital projects, while giving consideration to the operational needs for balance of the utility business capital expenditures.

The lumpy rate increases inherent with tradition rate base treatment of major capital projects are a challenge in this context. One approach that could be used to smooth out the rate impact of significant major capital investments is to allow for the inclusion of the Construction Work in Progress (CWIP) associated with major projects to be included in rate base. This approach would also benefit customers through a lower total cost for each project, as AFUDC financing charges would not be added to a project's cost. This treatment for major capital investments is one that a number of other jurisdictions have adopted; while we have not included that treatment in our rate and bill impact calculations, we believe it is a concept that should be considered, perhaps for all new significant major projects greater than \$50M, as these plans move from proposals to projects.

It is important to note that annual rate change is a more constraining constraint as compared to total bill impact because of the anticipated sales volume reduction impact of energy efficiency measures.

### Impact of Energy Efficiency Portfolio Standard on Rates and Customer Bills

Hawai‘i’s Energy Efficiency Portfolio Standard (EEPS) is guiding significant improvements in energy efficiency across all customers and is a primary driver of the decline in kWh sales through 2030. These usage declines are incorporated into the sales forecasts used for the PSIP analyses. Figure I-4 provides a perspective on the significance of this impact on projected sales volume for O‘ahu. While these net sales figures include the impact of both EEPS and the standard DER penetration assumptions, the DER impact is generally constant year to year, so the shape of the curve is driven by the EEPS impact.

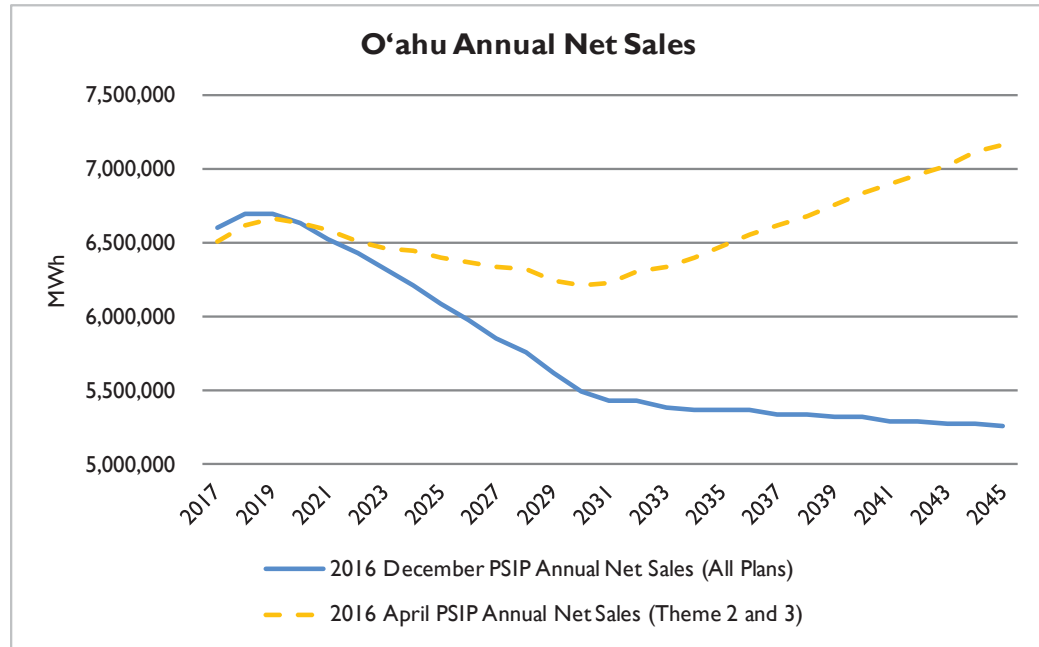

Figure I-4. Impact of Energy Efficiency Portfolio Standard on Sales

These sales volume changes are allocated across all customer classes in the PSIP analyses and do impact both the residential rate and residential customer bill impact analyses. While factors, including the applicable level of DG-PV penetration, do impact the specific calculations by resource plan for each island, the calculated usage per non-DG-PV residential customer varies with the EEPS driven net sales decline (Figure I-5).

## I. Financial Analyses and Bill Impact Calculations

Iterative Top-Down Methodology

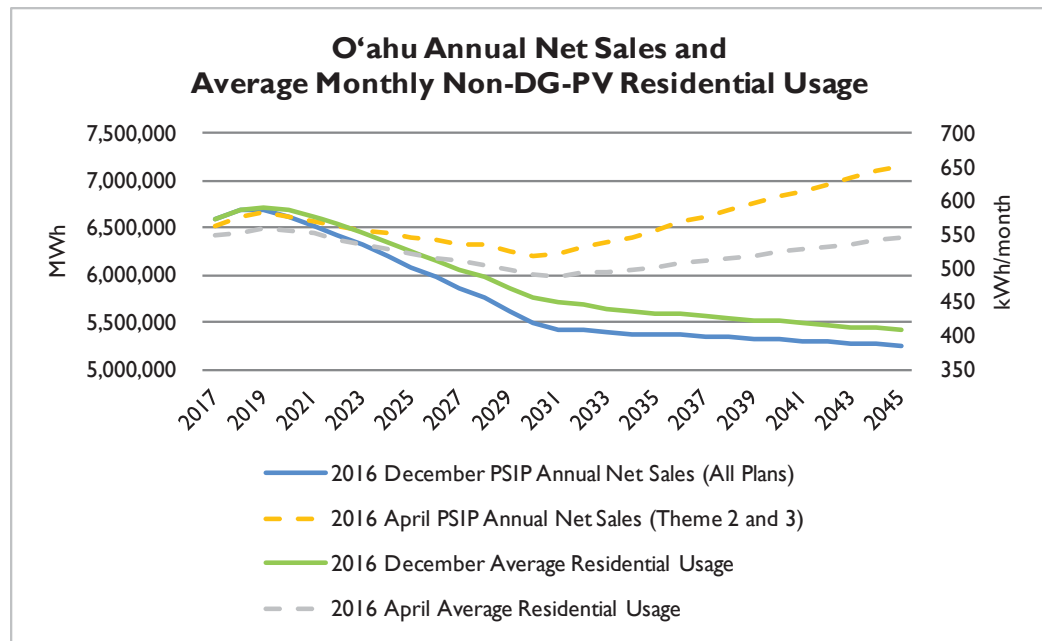

Figure I-5. Impact of Energy Efficiency Portfolio Standard on Sales & Residential Usage

### Applying the Rate Change Test Iteratively

To test each scenario against this initial rate change limit, we have combined the annual capital expenditures, fuel, and operating costs associated with the PSIP Plans with the annual capital expenditure and operating cost projections for the balance of the utility business to calculate an initial rate impact for each. We use the twelve month average 2015 residential rate level for each island as the starting point for this analysis. The use of a twelve month average rate provides some degree of smoothing to the very volatile monthly rates customers have experienced, due to the dramatic swings in oil prices.

For any year in which an operating utility plan results in a rate change greater than the annual ceiling, we review and adjust the timing and magnitude of the capital expenditures associated with the balance of the utility business or of significant major projects within that time frame, as appropriate. Exceptions were allowed in certain years due to the implementation of significant major capital projects.

Through iteration we calculate a capital expenditure profile that results in annual rate changes less than or equal to the ceiling, with limited exceptions due to significant major projects, and is consistent across all plans, so as to ease direct comparison of revenue requirements and customer bill impacts between plans.

## Alignment with Existing Capital Plans and Ability to Meet Customer Requirements Test

This top-down, balance-of-utility business constrained capital expenditure plan will be reviewed to ensure that it reflects investment levels that will continually meet customer requirements for new service, maintain or enhance service reliability, and enable timely modernization of the grid to enable the distributed energy resources called for in the PSIP Plans. Management judgment will be applied to the timing and magnitude of the total capital expenditure plan to adjust as appropriate so as to ensure these critical customer requirements will be met.

## Resource Usage Test

Lastly, final balance-of-utility business capital expenditure plan will be reviewed from a resource management perspective. Cost effective execution of capital work requires effective use of existing and future Company resources, especially in transmission and distribution. A degree of consistency in the level of investment is highly desirable given the availability and mobilization costs of contract resources in Hawai'i and the required investment and timeline for training and development of Company resources. Here again, management judgment will be applied to determine if adjustments to the magnitude and timing of the final balance-of-utility business capital expenditure plan is required.

---

## OPERATIONS AND MAINTENANCE EXPENSES

Operating and maintenance (O&M) expenses are a broad category of expense, which we have projected in three distinct ways. First, PSIP-related O&M is projected for each resource plan as modeled, based on the resource cost, retirement, and transition costs associated with each resource plan. Second, for Smart Grid and ERP, specific O&M cost adjustments are used, consistent with the respective General Order 7 applications.<sup>3</sup> Third, for Hawaiian Electric and Hawai'i Electric Light, specific requested rate case increases<sup>4</sup> for O&M are used for the 2017 and 2016 test years respectively. For Maui Electric's expected 2018 Test Year Rate Case, the test year O&M increase was based on the average of Hawaiian Electric's and Hawai'i Electric Light's submitted rate cases identified above. The remaining operating and maintenance costs are projected to increase at the rate of inflation over the 30 year forecast period.

---

<sup>3</sup> Applications to the Commission for approval to commit funds in excess of \$2.5 million.

<sup>4</sup> Hawai'i Electric Light 2016 Test Year Rate Case, Docket No. 2015-0170; Hawaiian Electric 2017 Test Year Rate Case, Docket No. 2016-0328.

## I. Financial Analyses and Bill Impact Calculations

### Taxes Other than Income and Public Benefits Fund

This assumption represents an intense pressure on operating costs, as labor costs comprise a significant percentage of these operating costs and skilled labor costs have consistently risen at rates above inflation in recent years. When this relationship is extended out over 30 years, it implies either a reversal of this labor cost relationship or very significant productivity gains must be achieved in order to meet this operating cost projection. If such gains are not achieved, future operating costs will be higher than the costs incorporated into the customer bill impact and rate analyses.

---

## TAXES OTHER THAN INCOME AND PUBLIC BENEFITS FUND

A material component of a customer's total electric bill is comprised of various taxes the Companies pay, as well as the public benefit fund charge the Companies collect to fund Hawai'i Energy's energy efficiency programs. The laws and regulations that govern these taxes and fees are assumed to remain constant throughout the forecast period. Taxes on fuel that are assessed volumetrically are projected consistent with the plan's expected fuel consumption. Other fees are assumed to increase at the rate of inflation.

The current public benefit fund charge of 2% of electric revenues, including revenue taxes, was applied throughout the planning period.

---

## RETURN ON AND OF EXISTING UTILITY ASSETS

The Companies have \$4.1 billion of net utility assets, as of December 31, 2015, including \$1.0 Billion of generating property, plant, and equipment assets. These existing assets are currently used and useful for utility service, are being depreciated, and the net balance is in rate base earning a return, based on the authorized capital structure and return on equity. The customer bill impact and rate impact analysis assumes the currently authorized capital structure, return on equity, and interim rate adjustment mechanisms are constant over the forecast period. Similarly, the analyses assume that depreciation rates for existing plant remain the same. Lastly, the analyses assume that upon retirement, undepreciated plant balances are transferred to a regulatory asset amortized over 20 years and that removal costs in excess of removal costs already recovered from customers, if any, are given the same regulatory treatment.

---

## CAPITAL INVESTMENTS IN POWER SUPPLY ASSETS

For each resource plan, all of the capital investments associated with the plan are summed by year to reflect the total annual capital expenditure for the new resources envisioned in the plan. In addition, each plan also includes the capital expenditures required for the major reliability investments for each existing generating unit that is expected to operate well into the 2030s or beyond. Lastly, routine generation capital expenditures already planned for 2017 through 2020 are included, and a provision of \$1 million per year per unit for capital expenditures associated with break or fix activities is included for each existing generating unit that remains operational beyond 2020.

These capital expenditures were modeled using the traditional rate base approaches for determining revenue requirements and customer rates. This approach assigns the capital cost recovery risk for these investments to customers and to the extent certain customers disconnect from the grid or significantly reduce their grid consumption, capital cost recovery would be shifted to the remaining customers. While the Companies are not yet in a position to make a specific proposal, we believe it is likely that capital cost recovery for certain of these power supply investments would be appropriately treated as a cost that cannot be bypassed. To the extent that we determine this is the case, we would anticipate including such a recommendation as part of any filing seeking approval of such a capital project.

---

## BALANCE-OF-UTILITY BUSINESS CAPITAL INVESTMENTS

The iterative top down methodology uses “balance-of-utility business” capital expenditures, as one of the adjustable inputs to achieve an acceptable rate trajectory. The balance of utility business capital expenditures are divided into two specific categories: (1) significant “balance-of-utility business” major project and (2) all other utility capital expenditures.

Significant major projects, requiring GO7 approval, include Smart Grid and ERP/EAM. Total capital expenditures and deferred software costs for these projects<sup>5</sup> are projected as follows:

- Significant “balance-of-utility business” major project capital expenditures
  - Smart Grid: \$346 million
  - ERP/EAM: \$78 million

---

<sup>5</sup> These are the cost estimates available at the time of this analysis. For the most complete and current cost estimates for these projects, please refer to the most recent filings applicable to each.



## I. Financial Analyses and Bill Impact Calculations

### Balance-of-Utility Business Capital Investments

It should be noted that capital expenditures for new office or yard facilities are not included in the customer bill impact and rate impact analyses. If, as the Companies continues to evaluate our facility requirements in the normal course of business, new facility investments can be justified, those would be evaluated on a stand-alone business case basis.

To frame the level of balance-of-utility business capital expenditures required over the forecast period, we considered several sources and perspectives. These include:

- Balance-of-utility business capital expenditure benchmark data for U.S. utilities indicate that for utilities with aging T&D assets, capital expenditures in the \$400 to \$600 per customer per year range are typical. This would suggest the following ranges for each operating utility:
  - Hawaiian Electric: \$120 million to \$180 million
  - Maui Electric: \$30 million to \$45 million
  - Hawai'i Electric Light: \$30 million to \$45 million
- Hawaiian Electric's most recent five years have averaged approximately \$190 million
- Engineering assessments across the Hawaiian Electric grids indicate significant reliability and capability issues that need to be addressed to ensure reliable service, particularly so given Hawaii's exposure to hurricanes and other major storms.
- Historical averages for a panel of US utilities indicate that approximately \$7.5 billion in balance of business utility capital expenditures are required for each 1% growth in GDP. Using DBEDT's forecasted growth rate of 2.33%, the projected balance-of-utility business capital expenditures are:
  - Hawaiian Electric: \$178 million
  - Maui Electric: \$44 million
  - Hawai'i Electric Light: \$43 million

Given these data, it is expected that the combination of the PSIP Preferred Plan capital expenditures and rate change limits could constrain balance-of-utility business capital expenditures for at least the first 10 to 15 years of the planning period.

## RETIREMENT AND REMOVAL COSTS

All of the Plans call for the deactivation and subsequent retirement of existing fossil generation units. For financial modeling, each unit is considered to be retired two years after it is deactivated, unless reactivation is explicitly planned in the resource plan. Further, we have assumed that each unit is removed in the year following retirement.

The net book value at retirement and the removal costs represent prudent expenditures that have served customers for many years and thus will need to be recovered from customers. We expect to seek Commission approval for recording these costs as a regulatory asset, to be amortized and recovered from customers over the 20 years following unit retirement. The financial results presented in this report are based on this approach.

Table I-1 presents the net book value of the units to be retired, annual depreciation expense, as well as the estimated removal costs for each.

Unit	Millions	Net Book Value: December 31, 2015	Annual Depreciation Expense	Estimated Removal Costs
Honolulu 8 & 9		\$49.4	\$1.6	\$20.0
Waiau 3 & 4		\$22.7	\$0.9	\$20.0
Waiau 5 & 6		\$39.8	\$1.2	\$20.0
Kahe 1-3		\$76.7	\$2.4	\$30.0
Kahe 4		\$24.9	\$1.0	\$10.0
Kahului 1-4		\$5.4	\$1.4	\$10.9
Puna Steam		\$11.4	\$0.4	\$4.0
Hill 5 & 6		\$14.5	\$1.0	\$9.0

Table I-1. Financial Data of Units to Be Retired

With the shift to renewable energy sources, several of the resource plans call for converting the generator of retired generating units for use as a synchronous condenser. In those cases, we have assumed that the generator assets and common plant that continue to be used for synchronous condenser operations will have a net book value of \$2 million per unit that will remain in service and \$1 million of removal costs will be avoided.

The net book value at retirement and the removal costs incurred represent prudent expenditures that have served customers for many years and thus will need to be recovered from customers. The financial results represent recovery of these costs from customers over a 20-year period following unit retirement.

## I. Financial Analyses and Bill Impact Calculations

### Retirement and Removal Costs

In prior PSIPs, we modeled the recovery of retirement and removal costs through a securitization mechanism. While this approach could be used, it may not prove to be cost effective because these costs are somewhat smaller than previously anticipated and are spread out over a number of years. This makes the administrative costs of establishing and using a securitization mechanism appear impractical.

We expect to seek Commission approval for recording these costs as a regulatory asset, to be amortized and recovered from customers over the 20-years following unit retirement.

There is one aspect of a standard utility securitization that does seem to be appropriate for these costs. Recovery of these costs on a non-bypassable basis from all current and future customers would be appropriate, as all current customers have benefited from the use of these assets. While this rate design topic is beyond the scope of this 2016 updated PSIP, we suggest that this concept be considered in future rate design discussions relating to retirement and removal costs.

## J. Modeling Assumptions Data

The Companies created this PSIP based on the current state of the electric systems in Hawai‘i, forecast conditions, and reasonable assumptions regarding technology readiness, availability, performance, applicability, and costs. As a result, this plan presents a reasonable and viable path into the future for the evolution of our power systems. We have documented and been fully transparent about the assumptions and methods used to develop this plan. We recognize, however, that over time, these forecasts and assumptions may or may not prove to be accurate or representative, and that the plan would need to be updated to reflect changes. We will continually evaluate the impacts of any changes to our material assumptions, seek to improve the planning methods, and evaluate and revise the PSIP to best meet the needs of our customers.

This appendix summarizes the modeling assumptions data used as input to our analyses conducted for creating the PSIP. This data includes:

- Reliability criteria
- Utility cost of capital
- Fuel price forecasts and availability
- Energy sales and peak demand forecasts and comparisons
- UHERO State of Hawai‘i Forecasts
- Resource capital costs
- Demand response data inputs

---

## RELIABILITY CRITERIA

### Adequacy of Supply

Every year, we file an Adequacy of Supply (AOS) report. This report indicates how the generation capacity on each island's power grid is able to meet all reasonably expected demand as well as provide a reasonable reserve to meet emergencies. The AOS for the island of O'ahu incorporates a Loss-of-Load Probability (LOLP) of, at most, one outage day every 4½ years in its overall capacity planning criteria.

Another commonly used planning metric for designing a system to meet the adequacy of supply requirements is "reserve margin". For the December 2016 updated PSIP, the production modeling teams assumed a minimum 30% planning reserve margin for generation on Maui and Hawai'i Island. Because of their smaller sizes, the islands of Lana'i and Moloka'i do not have a reserve margin reliability criteria, but plan for sufficient generating capacity to serve the system demand in the event of a loss of the largest unit or a unit on maintenance.

The planning reserve margin for O'ahu was assumed to be a minimum of 45% to approximate the LOLP guideline of one outage day every 4½ years for O'ahu. O'ahu's proxy 45% reserve margin threshold for long-term modeling purposes was estimated using LOLP analysis from Hawaiian Electric's 2007 to 2016 AOS reports. The reserve margin at the point where capacity would be needed according to the LOLP guideline was determined for many situations. On average, capacity needed to be added when the reserve margin fell to 45%.

The benefit of using reserve margin as a proxy for the actual LOLP guideline is that resource optimizations for long-term plans can be performed relatively quickly. Reserve margin calculations are relatively simple while LOLP calculations are very complex. We would analyze LOLP to determine when adequacy of supply in the near-term and to support applications for approval to add new, firm capacity.

Reserve margin calculations are deterministic in that the reserve margin for a system is calculated from discrete additions and subtractions of capacity. Firm and variable generation resources, as well as other limited run-time options (such as demand response and energy storage), were assumed to contribute capacity value to fulfill the reserve margin targets.

These thresholds use this formula to calculate the percent criteria for reserve margin:

The utility will maintain a minimum XX% Reserve Margin ( $F_{RM}$ ) over the annual system peak.

$$\frac{\sum_{i=1}^N N_i + L_{QC} - (L_{Peak} - L_{DR})}{(L_{Peak} - L_{DR})} \geq F_{RM}$$

Where:

- $F_{RM}$  is the Reserve Margin.
- $N_i$  is the normal net capability of all firm units.
- $L_{DR}$  is the amount of interruptible load available and measurable for the interruption for the entire period of the expected capacity shortfall.
- $L_{QC}$  is the estimated capacity value of grid scale variable renewable and stored energy generation on the system.
- $L_{Peak}$  is the forecasted annual system peak load.

As the systems evolve, the target reserve margin and capacity planning criteria will be periodically evaluated to ensure resource adequacy and supply, with consideration of the resource risk based historical performance of the types of resources providing the capacity. A search of capacity planning studies resulted in numerous papers and issues that are continuing to be studied in many different jurisdictions. One example from a study in New England<sup>1</sup> stated the following when planning for system adequacy:

Energy storage has the capacity to change the load shape and reduce LOLE, but in systems with very high penetration of variable renewable energy and large-scale storage, a new framework may be required to ensure system adequacy and to credit those system components with their capacity value in a way that is clear, fair and effective. Energy storage systems obviously do not provide net energy, and only provide capacity value when they are in the presence of generators.

In power systems which include very high wind penetration (Above 50%) or similar penetrations of other variable, renewable energy, system adequacy calculations may need to take a different form.<sup>2</sup>

Our island systems are at these planning thresholds and beyond to achieve a 100% renewable future, and will need to evolve with best practices for capacity and resource planning as they continue to meet changing needs.

<sup>1</sup> Letson, Frederick. (2015). *Wind Power Capacity Value Metrics and Variability: A Study in New England*; [http://scholarworks.umass.edu/dissertations\\_2/474/](http://scholarworks.umass.edu/dissertations_2/474/).

<sup>2</sup> *ibid.*, at 129.

### Capacity Value of Variable Generation, Storage, and Demand Response

Evaluating the potential to remove firm capacity generators from service—or retire them—as new resources become available must consider both reliability and adequacy of supply. Adequacy of supply evaluates whether sufficient energy capacity exists to serve the forecast demand. This evaluation must reflect the difference between conventional fossil generation and new resources.

Wind and solar cannot be scheduled to operate, as their output is variable and dependent upon availability of the resource. Determining variable resource capacity value (contribution to adequate energy supply) with a high level of confidence is a considerable challenge. Demand Response and storage differ from historical generators in being finite energy resources—the capacity is available for a specific duration beyond which it cannot be relied upon to provide energy.

An accurate determination of the capacity value of these new types of resources is critical to ensure that customer demand can be reliably met with the anticipated mix of new resources. This consideration is particularly important for the autonomous island systems in Hawai'i as the resources are limited to those available within each island's service area.

### Capacity Value of Wind Generation

The capacity value of existing and future wind resources is determined using a statistical correlation of wind output during the peak hour of each day. A 90% probability or confidence level was used to estimate the capacity value towards capacity planning. The peak demand hour was used for evaluation of historical data. In the future, additional assessments will consider a four-hour peak period to ensure adequacy of supply for the shoulder periods.

The 90% confidence level was based on a consideration of the performance of Hawaiian Electric's firm capacity units. For example, the recorded Equivalent Forced Outage Rate (Demand) (EFORd)<sup>3</sup> was 10.2% in 2015. Between 2009 and 2014, the value ranged from a low of 3.4% (2013) to a high of 5.9% (2014).<sup>4</sup> A simple unweighted average of 2009–2015 EFORd would yield 5.1%. In the probability analysis, a higher confidence level would result in a lower capacity value. Using a 95% confidence level (approximately corresponding to the simple unweighted average of 2009–2015 EFORd), the capacity value of wind would be zero. A 90% confidence level (approximately corresponding to the worst EFORd year) still resulted in a wind capacity value of zero.

<sup>3</sup> EFORd weights forced outages more heavily during periods when demand is high since that is when capacity is needed the most. Maui Electric and Hawai'i Electric Light do not use the EFORd metric.

<sup>4</sup> Hawaiian Electric's 2016 Adequacy of Supply, filed on January 29, 2016.

Similar confidence levels have been reviewed at other jurisdictions (such as Southwest Power Pool and Bonneville Power Administration).<sup>5</sup>

The capacity value of wind at each facility is based on the daily historical availability of the wind resource to serve demand during the peak periods when capacity is needed. This historical valuation was applied to the future, including for new resources, as an approximation. The contribution would be reassessed upon actual installation based on the wind profile and production of the specific site and equipment, and its correlation to future demand profiles (the relationship anticipated to change over time).

Currently, there are no wind facilities on Lana‘i and Moloka‘i. Historical data would be required to establish the capacity value of a wind facility developed on these islands. It should be noted that because of varying wind regimes, the established wind capacity value differs on O‘ahu, Maui, and Hawai‘i Island.

**Hawaiian Electric Capacity Value of Wind.** Based on an examination of historical available wind capacity during the peak period hours, the two existing wind facilities (30 MW Kahuku Wind and 69 MW Kawailoa Wind) do not contribute to capacity planning. There was a poor correlation (less than 90% confidence level) between wind output and peak period hours. Capacity contribution from future resources would be reassessed upon actual installation based on the wind profile and production of the specific site and equipment. In addition, correlating to future demand peak periods may change the resulting capacity value.

**Maui Electric Capacity Value of Wind.** Based on historical examination of available wind capacity during the peak period hours, the aggregate capacity planning value of the three existing wind facilities (30 MW Kaheawa Wind Power I, 21 MW Kaheawa Wind Power II, and 21 MW Auwahi Wind Energy) is about 2.8 MW.

For PSIP modeling, the capacity value of future Maui wind facilities is 3.9% of the facility’s nameplate value. This is an approximation. The contribution would be reassessed upon actual installation based on the wind profile and production of the specific site and equipment. As with Hawaiian Electric, correlating to future demand peak periods may change the resulting capacity value.

**Hawai‘i Electric Light Capacity Value of Wind and Run of River Hydroelectric.** Based on an historical examination of available wind capacity during the peak period hours, the aggregate capacity planning value of the two existing wind facilities (20.5 MW Tawhiri wind and 10.56 MW Hawi Renewable Development wind) is about 3.7 MW. Using this same methodology, the capacity value of the hydroelectric facilities is about 1 MW.

---

<sup>5</sup> J. Rogers and K. Porter, (2012). Summary of Timer Period-Based and Other Approximation Methods for Determining the Capacity Value of Wind and Solar in the United States. [www.nrel.gov/docs/fy12osti/54338.pdf](http://www.nrel.gov/docs/fy12osti/54338.pdf)



## J. Modeling Assumptions Data

### Reliability Criteria

For PSIP modeling, the capacity value of future Hawai'i Island wind facilities is 12% of the facility's nameplate value, and the capacity value of hydroelectric facilities is 6% of the facility's nameplate value. This is an approximation. The contribution would be reassessed upon actual installation based on the wind profile and production of the specific site and equipment. Again, correlating to future demand peak periods may change the resulting capacity value.

### Capacity Value of Solar Generation

The approach to valuating the capacity value of solar is the same as used for the variable wind and hydro. Thus capacity value of solar generation is highly dependent on correlating to peak periods. Using the same capacity valuation methodology as for wind and hydroelectric resources, based on historical peak period hours, the capacity value of existing and future grid-scale PV and DG-PV is 0. This result is driven by the fact that variable PV does not produce during the peak evening period after the sun has set.

If a capacity valuation methodology is used, changes in the load shape from DR programs and energy storage are accounted for (as an example, DR programs and energy storage move the demands from evening periods into the midday). In that case, the capacity value of solar generation could be nonzero. In the E3 methodology, the capacity value of solar depends on the hour of the day. The capacity value is highest during the midday hours and zero during the evening peak. Applying this methodology may also change the capacity value of wind and hydroelectric resources.

The planning reserve margin (PRM) analysis was performed by E3; it is described in Appendix C: Analysis Methods and Models and in Appendix P: Consultant Report.

### Capacity Value of Demand Response

The estimated megawatt potential from various programs is included in PSIP capacity planning based on updated program potential from March 2016. These programs include the Residential and Small Business Direct Load Control, Commercial and Industrial Direct Load Control, Customer Firm Generation, and Time-of-Use.

## Required Regulating Reserve

General Electric (GE), working under a contract with the Hawai'i Natural Energy Institute (HNEI)<sup>6</sup>, developed a formula for determining the amount of regulating reserve necessary to maintain the minute-to-minute balance between supply and demand on the O'ahu grid. The formula is:

Required regulating reserve amount equals the sum of:

Approximately 1 MW regulating reserve for each 1 MW of delivered wind and PV generation up to 18% of nameplate capacity of wind and PV during daytime the hours of 7 AM to 6 PM; plus

1 MW regulating reserve for each 1 MW of delivered wind and PV generation up to 23% of nameplate capacity during the hours of 6 PM to 7 AM

GE developed the formula by converting the hourly MW reserve requirements from previous studies into an hourly reserve requirement as a percent of the total online renewable capacity. The reserves represent the regulating reserve portion of the total reserve requirement only after taking into account quick-start reserve capability on O'ahu provided by existing gas-turbine and reciprocating engines (CIP CT-1, Airport DSG, Waiiau 9, and Waiiau 10).

Electric Power Systems (EPS) developed a formula for Lana'i, Moloka'i, and Hawai'i Island. The formulas are based on resources whose outputs respond directly to energy source availability, without mitigation for smoothing or ramp control. That formula is:

Required regulating reserve amount equals the sum of:

1 MW regulating reserve for each 1 MW of delivered wind generation up to 50% of nameplate capacity of wind, plus

1 MW regulating reserve for each 1 MW delivered DG-PV generation up to 20% of nameplate capacity of DG-PV, plus

1 MW regulating reserve for each 1 MW of delivered utility-scale PV generation up to 60% of nameplate capacity of utility-scale PV

---

<sup>6</sup> Refer to HNEI study material <http://www.hnei.hawaii.edu/projects/hawaii-rps-study> and <http://www.hnei.hawaii.edu/projects/hawaii-solar-integration> for more information.

## J. Modeling Assumptions Data

### Reliability Criteria

The amount of regulating reserve required on Maui to regulate frequency because of the variability of output from variable generation resources is currently determined from a formula derived in the December 19, 2012 Hawai'i Solar Integration Study prepared by GE for the National Renewable Energy Laboratory, HNEI, Hawaiian Electric Company and Maui Electric Company. That formula is:

The greater of 6 MW, or  
1 MW regulating reserve for each 1 MW of delivered wind and solar power up to a maximum of 27 MW, less 10 MW for the KWP II BESS. (Solar power includes behind-the-meter and grid-side PV.)

Maui Electric plans to transition to the EPS regulating reserve formula. But first, Maui Electric must determine the effects on costs and curtailment with the addition of 40 MW of internal combustion engines, a 20 MW regulating reserve BESS, a 20 MW contingency reserve BESS, and the decommissioning of Kahului Power Plant.

## UTILITY COST OF CAPITAL AND FINANCIAL ASSUMPTIONS

The Hawaiian Electric Companies finance their investments through two main sources of capital: debt (borrowed money) or equity (invested money). In both cases, we pay a certain rate of return for the use of this money. This rate of return is our *Cost of Capital*.

Table J-1 lists the various sources of capital, their weight (percent of the entire capital portfolio), and their individual rates of return. Composite percentages for costs of capital are presented under the table.

Capital Source	Weight	Rate
Short Term Debt	3.0%	4.0%
Long Term Debt (Taxable Debt)	39.0%	7.0%
Hybrids	0.0%	6.5%
Preferred Stock	1.0%	6.5%
Common Stock	57.0%	11.0%

Composite Weighted Average 9.185%

After-Tax Composite Weighted Average 8.076%

Table J-1. Utility Cost of Capital

---

## FUEL PRICE FORECASTS AND AVAILABILITY

The potential cost of producing electricity depends, in part, on the cost of fuels utilized in the generation of power. The cost of different fuels over the next 20-plus years are forecast and used in the PSIP analyses. The Companies use the following different types of fuels in our company-owned generators:

- Low Sulfur Fuel Oil (LSFO). A residual fuel oil similar to No. 6 fuel oil that contains less than 5,000 parts per million of sulfur; about 0.5% sulfur content.
- No.2 Diesel Oil
- Ultra-Low Sulfur Diesel (ULSD)
- Naphtha
- Medium Sulfur Fuel Oil (MSFO containing less than 2% sulfur; also called ISO-Industrial Fuel Oil)
- Biodiesel

### Petroleum-Based Fuels

The petroleum-based fuel forecasts reflect forecast data for Imported Crude Oil and Gross Domestic Product (GDP) Chain-Type Price Index from the U.S. Energy Information Administration (EIA) Annual Energy Outlook (AEO) Early Release report published in May 2016. Historical prices for crude oil are EIA publication table data for the Monthly Energy Review and macroeconomic data. Historical actual fuel costs incorporate taxes and certain fuel-related and fuel-handling costs including but not limited to trucking and ocean transport, petroleum inspection, and terminal fees.

The April 2015 AEO placed the price of Brent crude oil at \$60 a barrel. By the end of 2015, the price had dropped to below \$40 a barrel – below the 2015 AEO low economic growth case which estimated 2016 Brent crude oil at over \$50 per barrel. The 2016 AEO Early Release estimated the average Brent crude oil price to be \$37 a barrel in 2016, rising to \$77 a barrel by 2020 as demand and supply come into balance.

In 2016, the ratio of oil to natural gas prices was approximately 2.5:1; the lowest in over ten years. The 2016 AEO Early Release projects that oil prices will begin to rise steadily over the next 25 years. Natural gas prices are projected to also grow, but more slowly based on likely improvements to extraction technologies. By 2015, oil-to-natural-gas prices are projected to increase to an approximate 4.9:1 ratio.

## LNG Fuel Price Forecasts

The April 2015 AEO reported that natural gas prices dropped from \$3/MMBtu to less than \$2/MMBtu.

The delivered LNG fuel price forecasts include cost information for the pipeline transport, LNG liquefaction, transportation of the LNG, and transportation logistics from the Companies' Containerized LNG Supply to Hawai'i RFP. The EIA forecasts are based on Henry Hub pricing. Henry Hub, a Louisiana natural gas distribution hub and pricing point for natural gas futures contracts, trades on the New York Mercantile Exchange (NYMEX). Natural gas prices are expected to increase gradually over the next decade. The LNG price forecasts used in the PSIP attempts to account for natural gas that is sourced from British Columbia. Based on the future's market pricing and historical data, gas sourced from Alberta (AECO market) and British Columbia (Station 2 gathering point) has traded at a discount to the United States Henry Hub pricing.

For Oahu's LNG pricing curves, we applied a negative 26.5% basis to create a Station 2 equivalent Henry Hub price. For example, a \$2.00/MMBtu Henry Hub price would equate to a \$1.47/MMBtu Station 2 price. We then applied a 4.5% adder to the derived Station 2 price to account for shrinkage on the pipelines from the Station 2 gathering point to the liquefaction plant.

The Companies contemplates that the natural gas for its LNG will be procured under a daily or monthly index, gathered at Station 2 and transported on the Spectra Energy Westcoast Transmission T-South pipeline. T-South is a looped (multiple pipeline) system that moves gas from Station 2 to the Huntingdon/Sumas trading pool. T-South firm capacity can be procured at a rolled-in tariff rate – if capital improvements are required to increase pipeline capacity, expansion costs are borne by all users on the pipeline. Charges to use the pipeline will be at a fixed tariff CAD/GJ rate, converted to \$/MMBtu. As a mature depreciating pipeline system, the general trend is towards stable long-term rates. The current rate is approximately \$0.32/MMBtu.

From the Sumas hub, gas will be distributed on the Fortis regulated Coastal Transmission System (CTS) to the existing FortisBC Energy Inc. (FEI) LNG facility on Tilsbury Island in Delta, British Columbia, Canada on the Fraser River. The CTS pipeline rate is regulated under the Rate Schedule 50 (RS50) tariff in units of CAD/GJ and converted to \$/MMBtu for the Hawaiian Electric contract. The FEI CTS system is designed to meet high winter peaking demand and is therefore under-utilized for a majority of the year. Therefore, if more flat non-peaking load is added, by Hawaiian Electric or other industrial demand, the general trend would be for rates to reduce. This is reflected in the RS50 rate floor which decreases as demand increases. The current tariff rate under RS50 is approximately \$0.42/ MMBtu.

## **J. Modeling Assumptions Data**

### Fuel Price Forecasts and Availability

The LNG fuel price forecasts in Table J-2 through Table J-4 represent the total variable costs of the LNG (including the gas commodity, taxes, port fees, wharfage, stevedoring, and other ancillary delivery service charges). Table J-5 lists the total nominal LNG costs, including variable and fixed costs. Fixed costs include liquefaction, pipeline tolls (for tariff service), and shipping charges.



**Hawaiian Electric Fuel Price Forecasts**

\$/MMBtu	Hawaiian Electric Fuel Price Forecasts					
	2016 EIA AEO Early Release					
Year	LSFO	No. 2 Diesel	ULSD	40% LSFO/ 60% ULSD	Biodiesel	LNG
2016	\$6.85	\$9.40	\$10.32	\$8.86	\$29.87	n/a
2017	\$9.13	\$11.78	\$12.76	\$11.24	\$32.31	n/a
2018	\$11.04	\$13.77	\$14.82	\$13.23	\$34.41	n/a
2019	\$13.85	\$16.69	\$17.81	\$16.15	\$37.30	n/a
2020	\$15.45	\$18.37	\$19.55	\$17.83	\$39.20	n/a
2021	\$16.77	\$19.78	\$21.01	\$19.23	\$40.93	\$7.61
2022	\$17.88	\$20.97	\$22.25	\$20.42	\$42.48	\$7.77
2023	\$18.76	\$21.93	\$23.24	\$21.36	\$43.76	\$8.03
2024	\$19.56	\$22.79	\$24.14	\$22.22	\$44.96	\$8.43
2025	\$20.48	\$23.79	\$25.17	\$23.21	\$46.28	\$8.71
2026	\$21.58	\$24.96	\$26.39	\$24.37	\$47.78	\$8.31
2027	\$22.60	\$26.06	\$27.53	\$25.46	\$49.23	\$8.43
2028	\$23.56	\$27.10	\$28.61	\$26.50	\$50.64	\$8.64
2029	\$24.75	\$28.37	\$29.93	\$27.76	\$52.28	\$8.85
2030	\$25.71	\$29.42	\$31.02	\$28.79	\$53.75	\$9.03
2031	\$27.09	\$30.89	\$32.55	\$30.26	\$55.62	\$9.15
2032	\$28.53	\$32.44	\$34.15	\$31.80	\$57.57	\$9.36
2033	\$30.05	\$34.06	\$35.83	\$33.41	\$59.60	\$9.48
2034	\$31.68	\$35.80	\$37.63	\$35.14	\$61.74	\$9.64
2035	\$33.02	\$37.24	\$39.13	\$36.57	\$63.66	\$9.78
2036	\$34.78	\$39.12	\$41.07	\$38.43	\$65.94	\$9.96
2037	\$36.19	\$40.64	\$42.65	\$39.94	\$67.95	\$10.07
2038	\$38.08	\$42.64	\$44.73	\$41.94	\$70.37	\$10.19
2039	\$39.77	\$44.45	\$46.60	\$43.74	\$72.63	\$10.49
2040	\$41.89	\$46.70	\$48.92	\$45.97	\$75.26	\$10.71
2041	\$43.62	\$48.54	\$50.83	\$47.81	\$77.54	\$10.94
2042	\$45.54	\$50.59	\$52.94	\$49.84	\$79.99	n/a
2043	\$47.51	\$52.67	\$55.10	\$51.92	\$82.48	n/a
2044	\$49.51	\$54.80	\$57.30	\$54.04	\$85.00	n/a
2045	\$51.56	\$56.97	\$59.54	\$56.20	\$87.55	n/a

Table J-2. Hawaiian Electric Fuel Price Forecasts (nominal dollars)



## J. Modeling Assumptions Data

Fuel Price Forecasts and Availability

### Maui Electric Fuel Price Forecasts

\$/MMBtu	Maui Electric Fuel Price Forecasts						
	2016 EIA AEO Early Release						
Year	MSFO	No. 2 Diesel	ULSD (Maui)	ULSD (Moloka'i)	ULSD (Lana'i)	Biodiesel	LNG
2016	\$5.59	\$9.52	\$9.87	\$11.09	\$14.07	\$29.87	n/a
2017	\$7.55	\$12.17	\$12.58	\$13.78	\$16.79	\$32.31	n/a
2018	\$9.19	\$14.40	\$14.86	\$16.05	\$19.08	\$34.41	n/a
2019	\$11.60	\$17.66	\$18.20	\$19.35	\$22.39	\$37.30	n/a
2020	\$12.98	\$19.53	\$20.12	\$21.27	\$24.35	\$39.20	n/a
2021	\$14.10	\$21.08	\$21.71	\$22.87	\$26.00	\$40.93	\$9.98
2022	\$15.06	\$22.40	\$23.06	\$24.23	\$27.42	\$42.48	\$10.18
2023	\$15.81	\$23.45	\$24.14	\$25.32	\$28.56	\$43.76	\$10.48
2024	\$16.49	\$24.40	\$25.12	\$26.31	\$29.60	\$44.96	\$10.92
2025	\$17.28	\$25.50	\$26.24	\$27.44	\$30.79	\$46.28	\$11.24
2026	\$18.21	\$26.79	\$27.57	\$28.78	\$32.18	\$47.78	\$10.89
2027	\$19.09	\$28.01	\$28.81	\$30.03	\$33.49	\$49.23	\$11.05
2028	\$19.91	\$29.15	\$29.98	\$31.22	\$34.73	\$50.64	\$11.30
2029	\$20.92	\$30.56	\$31.43	\$32.67	\$36.24	\$52.28	\$11.57
2030	\$21.74	\$31.70	\$32.60	\$33.86	\$37.50	\$53.75	\$11.79
2031	\$22.92	\$33.33	\$34.27	\$35.55	\$39.25	\$55.62	\$11.96
2032	\$24.16	\$35.04	\$36.02	\$37.31	\$41.07	\$57.57	\$12.22
2033	\$25.45	\$36.83	\$37.86	\$39.15	\$42.99	\$59.60	\$12.39
2034	\$26.85	\$38.75	\$39.83	\$41.13	\$45.03	\$61.74	\$12.60
2035	\$27.99	\$40.34	\$41.46	\$42.78	\$46.76	\$63.66	\$12.79
2036	\$29.50	\$42.42	\$43.59	\$44.91	\$48.96	\$65.94	\$13.02
2037	\$30.70	\$44.09	\$45.30	\$46.65	\$50.77	\$67.95	\$13.19
2038	\$32.32	\$46.32	\$47.58	\$48.93	\$53.12	\$70.37	\$13.36
2039	\$33.77	\$48.31	\$49.63	\$50.99	\$55.25	\$72.63	\$13.72
2040	\$35.59	\$50.81	\$52.18	\$53.54	\$57.88	\$75.26	\$14.00
2041	\$37.07	\$52.85	\$54.27	\$55.64	\$60.05	\$77.54	\$14.29
2042	\$38.71	\$55.11	\$56.59	\$57.97	\$62.44	\$79.99	n/a
2043	\$40.39	\$57.42	\$58.96	\$60.34	\$64.88	\$82.48	n/a
2044	\$42.11	\$59.78	\$61.37	\$62.76	\$67.37	\$85.00	n/a
2045	\$43.86	\$62.18	\$63.84	\$65.23	\$69.90	\$87.55	n/a

Table J-3. Maui Electric Fuel Price Forecasts (nominal dollars)

### Hawai'i Electric Light Fuel Price Forecasts

\$/MMBtu	Hawai'i Electric Light Fuel Price Forecasts					
	2016 EIA AEO Early Release					
Year	MSFO	No. 2 Diesel	ULSD	Naphtha	Biodiesel	LNG
2016	\$5.90	\$9.98	\$10.25	\$11.96	\$29.87	n/a
2017	\$7.88	\$12.55	\$12.88	\$14.40	\$32.31	n/a
2018	\$9.54	\$14.70	\$15.09	\$16.46	\$34.41	n/a
2019	\$11.98	\$17.86	\$18.31	\$19.44	\$37.30	n/a
2020	\$13.37	\$19.68	\$20.17	\$21.19	\$39.20	n/a
2021	\$14.51	\$21.19	\$21.72	\$22.67	\$40.93	\$10.20
2022	\$15.48	\$22.48	\$23.05	\$23.93	\$42.48	\$10.41
2023	\$16.24	\$23.51	\$24.10	\$24.94	\$43.76	\$10.71
2024	\$16.93	\$24.44	\$25.05	\$25.87	\$44.96	\$11.16
2025	\$17.73	\$25.51	\$26.15	\$26.92	\$46.28	\$11.48
2026	\$18.68	\$26.78	\$27.45	\$28.16	\$47.78	\$11.14
2027	\$19.57	\$27.97	\$28.66	\$29.33	\$49.23	\$11.30
2028	\$20.40	\$29.09	\$29.81	\$30.44	\$50.64	\$11.56
2029	\$21.43	\$30.46	\$31.21	\$31.78	\$52.28	\$11.83
2030	\$22.26	\$31.59	\$32.36	\$32.90	\$53.75	\$12.05
2031	\$23.46	\$33.18	\$33.99	\$34.45	\$55.62	\$12.23
2032	\$24.71	\$34.85	\$35.70	\$36.08	\$57.57	\$12.50
2033	\$26.03	\$36.60	\$37.49	\$37.79	\$59.60	\$12.67
2034	\$27.44	\$38.47	\$39.41	\$39.62	\$61.74	\$12.89
2035	\$28.60	\$40.03	\$41.00	\$41.15	\$63.66	\$13.09
2036	\$30.13	\$42.05	\$43.07	\$43.12	\$65.94	\$13.32
2037	\$31.35	\$43.69	\$44.75	\$44.73	\$67.95	\$13.49
2038	\$32.99	\$45.86	\$46.97	\$46.83	\$70.37	\$13.68
2039	\$34.46	\$47.80	\$48.96	\$48.73	\$72.63	\$14.04
2040	\$36.30	\$50.23	\$51.45	\$51.08	\$75.26	\$14.32
2041	\$37.80	\$52.22	\$53.48	\$53.01	\$77.54	\$14.62
2042	\$39.47	\$54.43	\$55.74	\$55.15	\$79.99	n/a
2043	\$41.17	\$56.68	\$58.04	\$57.33	\$82.48	n/a
2044	\$42.91	\$58.97	\$60.39	\$59.56	\$85.00	n/a
2045	\$44.69	\$61.31	\$62.79	\$61.82	\$87.55	n/a

Table J-4. Hawai'i Electric Light Fuel Price Forecasts (nominal dollars)

## J. Modeling Assumptions Data

Fuel Price Forecasts and Availability

### LNG Total Cost Price Forecasts

#### 2016 EIA Total Cost Henry Hub Spot Prices for Natural Gas

\$/MMBtu	2016 EIA Total Cost Henry Hub Spot Prices for Natural Gas		
	<i>O'ahu Total Cost</i>	<i>Maui Total Cost</i>	<i>Hawai'i Island Total Cost</i>
Year			
2021	\$14.76	\$17.09	\$17.31
2022	\$15.01	\$17.38	\$17.61
2023	\$15.35	\$17.76	\$17.99
2024	\$15.83	\$18.28	\$18.52
2025	\$16.20	\$18.69	\$18.93
2026	\$15.88	\$18.42	\$18.67
2027	\$16.09	\$18.67	\$18.92
2028	\$16.39	\$19.02	\$19.27
2029	\$16.70	\$19.37	\$19.63
2030	\$16.96	\$19.68	\$19.95
2031	\$17.18	\$19.95	\$20.22
2032	\$17.49	\$20.31	\$20.59
2033	\$17.71	\$20.57	\$20.86
2034	\$17.97	\$20.89	\$21.18
2035	\$18.22	\$21.19	\$21.48
2036	\$18.50	\$21.52	\$21.82
2037	\$18.72	\$21.80	\$22.10
2038	\$18.95	\$22.08	\$22.39
2039	\$19.36	\$22.55	\$22.86
2040	\$19.69	\$22.94	\$23.26
2041	\$20.05	\$23.35	\$23.68

Table J-5. 2016 EIA Total Cost Henry Hub Spot Prices for Natural Gas (reference case—nominal dollars)

### Hawaiian Electric Fuel Price Forecast Trends

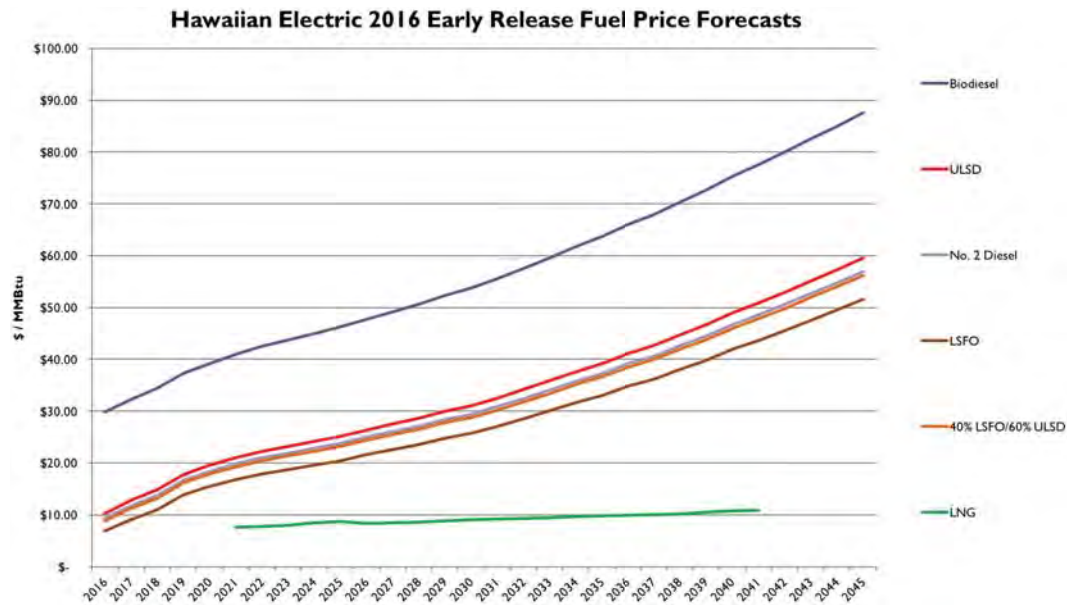

Figure J-1. Hawaiian Electric Fuel Price Forecast Trends (nominal dollars)

### Maui Electric Fuel Price Forecast Trends

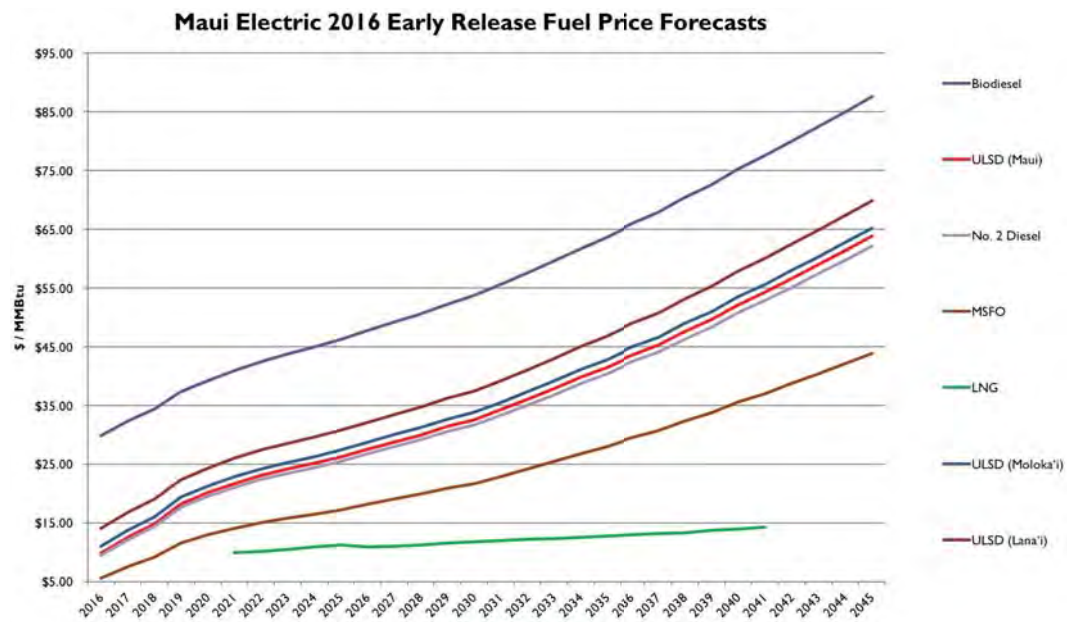

Figure J-2. Maui Electric Fuel Price Forecast Trends (nominal dollars)

## J. Modeling Assumptions Data

Fuel Price Forecasts and Availability

### Hawai'i Electric Light Fuel Price Forecast Trends

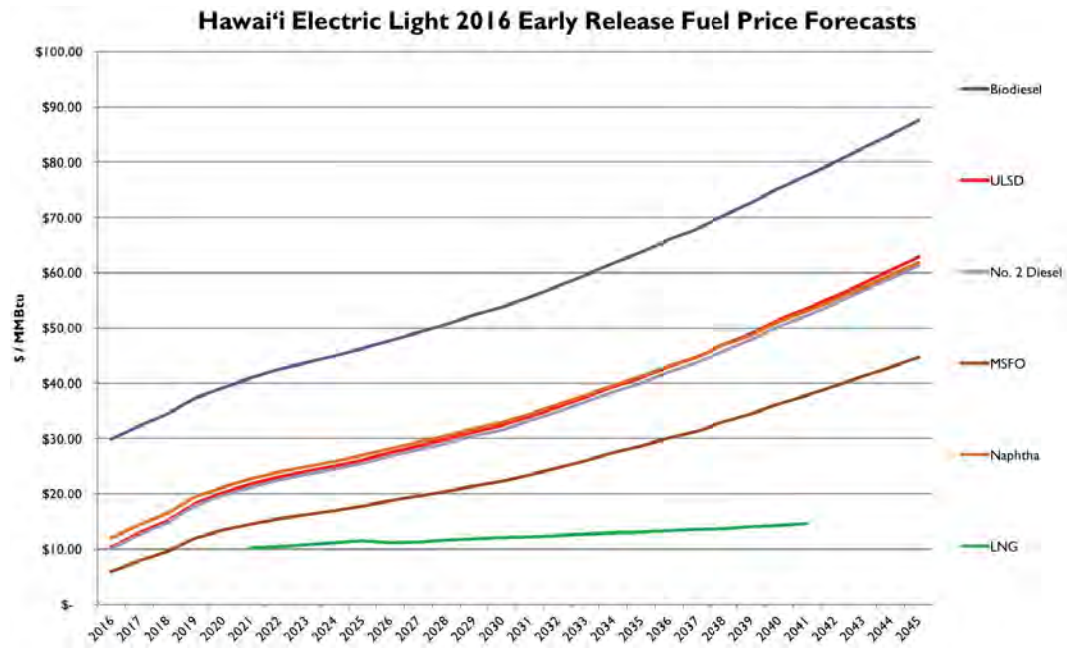

Figure J-3. Hawai'i Electric Light Fuel Price Forecast Trends (nominal dollars)

---

## ENERGY SALES AND PEAK DEMAND FORECAST

The purpose of the load (or peak demand) and sales (energy) forecasts in a planning study is to provide the energy requirements (in GWh) and peak demands (in MW) that must be served by the Company during the planning study period. Forecasts of energy requirements and peak demand must take into account economic trends and projections and changing end uses, including the emergence of new technologies.

The forecast developed for the February 2016 interim filing was one of the key assumptions that fed into the beginning of an iterative process used to determine varying levels of customer adoption of DER and participation in DR programs to achieve system optimization. As described in Appendix C: Analysis Methods and Models, the PSIP optimization process involves iterative cycles that analyze DER, DR and utility-scale resources in production simulation and financial rate models toward selecting a preferred plan. Forecast sensitivities were developed as a result of varying the levels of DER and DESS adoption.

These sensitivities and iterations led to the forecast used for this December 2016 update, which differs from the forecasts in the February 2016 and April 2016 updates in the amount of customer adoption of DER. Although DR and behind the meter energy storage (DESS) projections and their influences are modeled in this December 2016 PSIP update, the sales and peak demand forecasts do not reflect any influence from DR programs, DESS, or modification of DER operation in response to grid reliability needs. Subsequent steps in the analysis process address these impacts. For instance, DR load shifting programs result in changes to customer load shape and therefore peak load at certain times. There is also a possibility that output of DER may be reduced in response to a system excess generation condition, which would be identified in subsequent analysis steps as well.

### Sales and Peak Demand Projections Methodology

The Company develops sales and peak demand forecasts on an annual basis and utilizes the latest information available at the time the forecast is prepared. The sales and peak forecasts adopted in May 2015 for all islands were used as the starting point for the sales and peak demand analyses, as they were the most currently available forecasts. As part of the first iteration in the PSIP optimization process the customer-sited distributed generation (DG-PV) projections in the May 2015 forecast were updated to reflect modifications to the existing Company tariffs identified in Decision and Order No. 33258 in Docket No. 2014-0192 received in October 2015 for use in the February 2016 interim filing. This order approved revised interconnection standards, the closing of the Net Energy Metering program and new options for customers aimed at continuing the

## J. Modeling Assumptions Data

### Energy Sales and Peak Demand Forecast

growth of rooftop solar while ensuring safe and reliable service. Subsequent to the February 2016 Interim filing, the DG-PV forecasts have been updated with each cycle of the iterative process described in Appendix C.

The methodology for deriving net peak demand and energy requirements to be served by the Company begins with the identification of key factors that affect load growth. These factors include the economic outlook, analysis of existing and proposed large customer loads, and impacts of customer-sited technologies such as energy efficiency measures and DG-PV. Impacts from emerging technologies such as electric vehicles (EV) and storage are also evaluated given their significant potential impact on future demand for energy.

The Company reached out to Hawai'i Energy to assist with the development of alternative energy efficiency forecasts to better address potential uncertainties. The Company received future energy efficiency program estimates from Hawai'i Energy and has been collaborating with Hawai'i Energy to understand how best to incorporate their projections into the broader long-term forecast. At this time, it is a work in progress that was not available to support the December 2016 PSIP update. However, the Company will use information provided by Hawai'i Energy to inform future forecasts and as part of a larger iterative cycle, the PSIP analyses could be incorporated into the ongoing Energy Efficiency Technical Working Group process.

## Energy Sales Forecast

In general, the underlying economy driven sales forecast ("underlying forecast") is first derived by using econometric methods and historical sales data, excluding impacts from energy efficiency measures and DG. This methodology captures the impact of economic growth, which is typically the most influential factor when forecasting long-term changes in sales and peak demand. Estimates of impacts from energy efficiency measures, DG installed through the Company's tariffed programs and electric vehicles (referred to as "layers") are then incorporated to adjust the underlying forecast to arrive at a preliminary sales forecast. This methodology is illustrated below in the following chart (Figure J-4). The forecast is then used to drive the DER optimization routine.

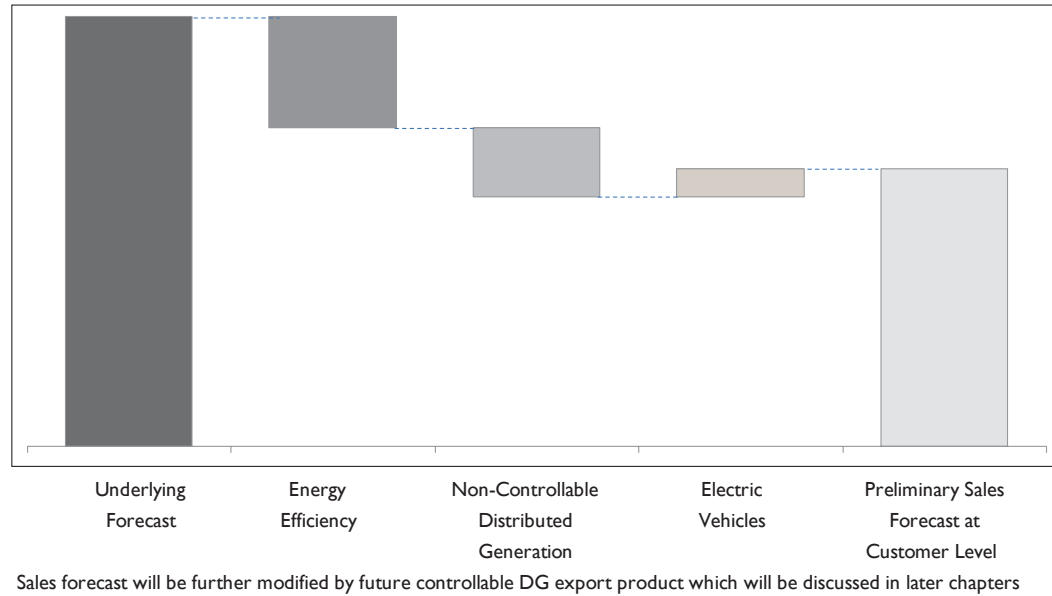

**Figure J-4. Illustrative Waterfall Methodology for Developing the Sales Forecast**

The forecasted sales used to be served by each operating company through the study period expressed at the customer level is shown in Figure J-5 through Figure J-9. This forecast depicts the starting point with market DG-PV forecasts used in the December 2016 PSIP update analyses. Data for the sales forecast projections are detailed in Table J-7 through Table J-11.

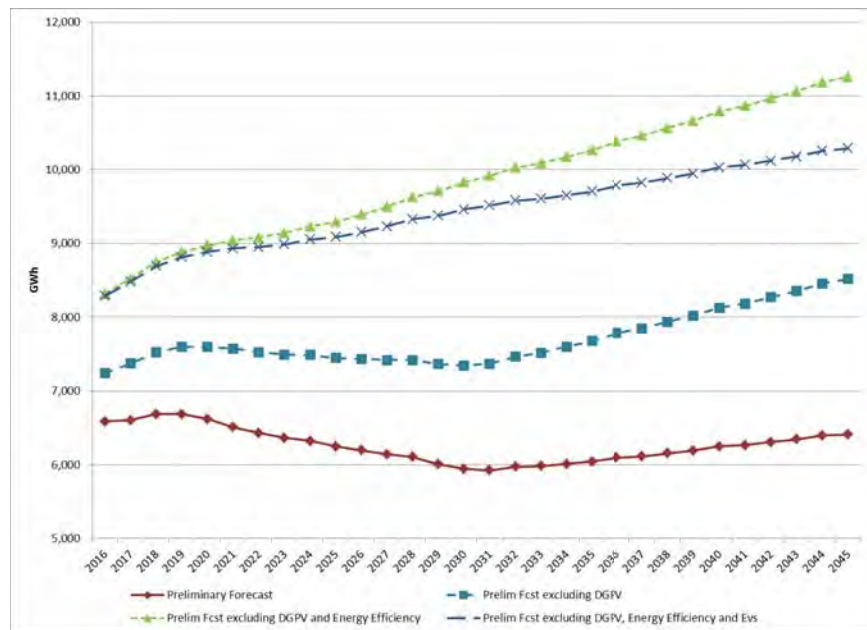

**Figure J-5. O'ahu Customer Level Sales Forecast**



## J. Modeling Assumptions Data

Energy Sales and Peak Demand Forecast

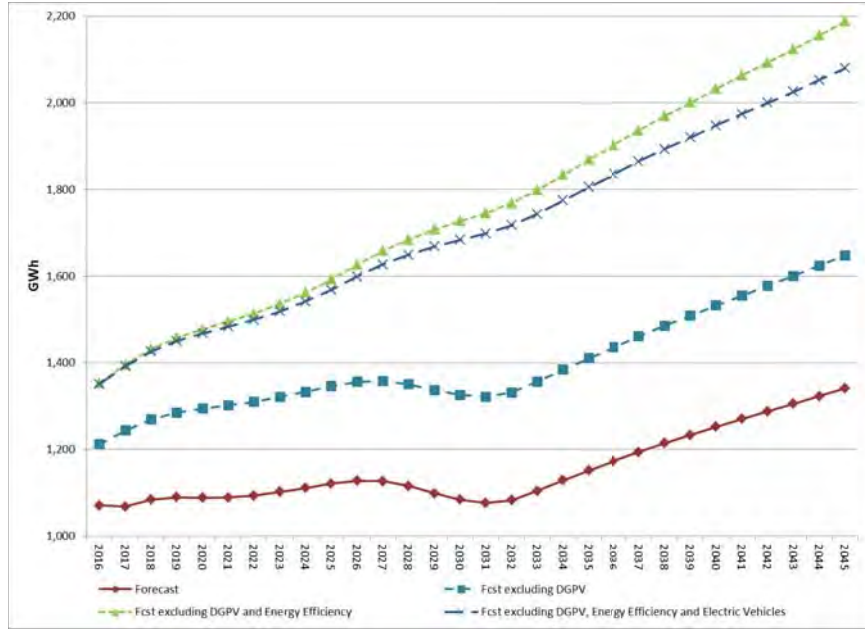

Figure J-6. Maui Island Customer Level Sales Forecast

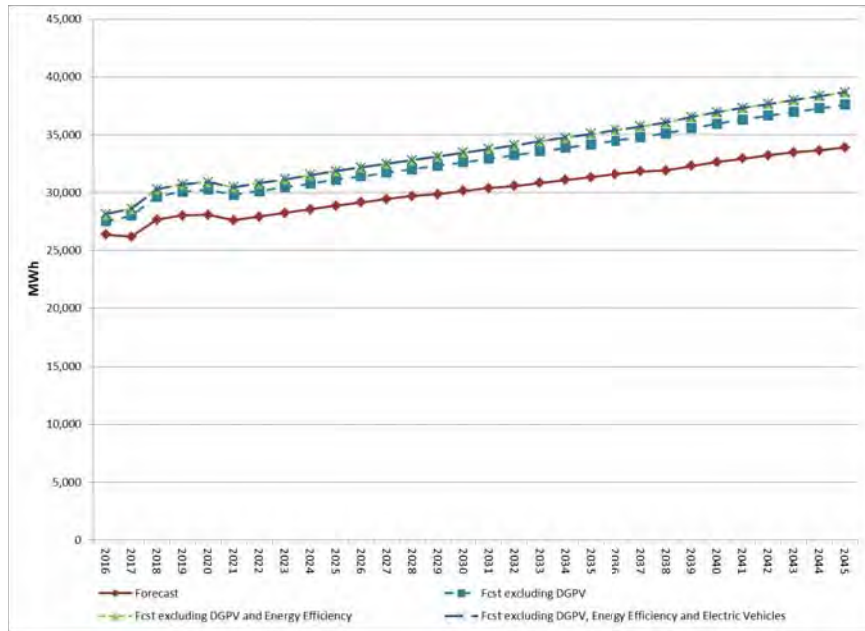

Figure J-7. Lana'i Customer Level Sales Forecast

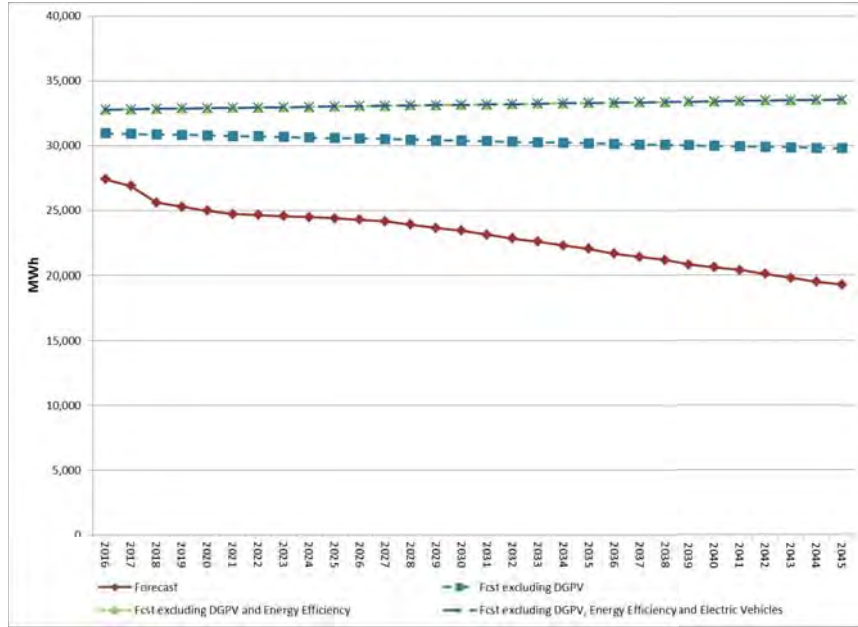

Figure J-8. Moloka'i Customer Level Sales Forecast

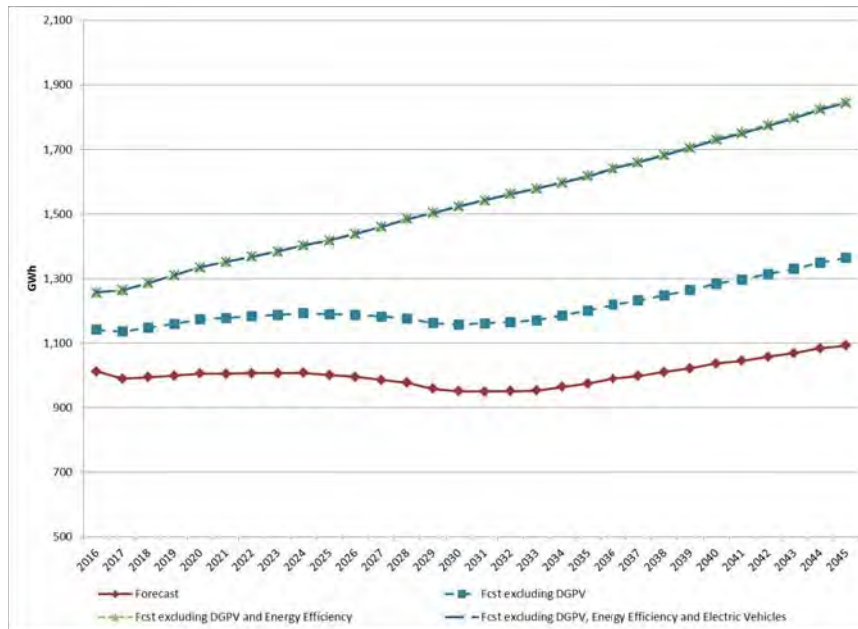

Figure J-9. Hawai'i Island Customer Level Sales Forecast

## J. Modeling Assumptions Data

Energy Sales and Peak Demand Forecast

### DG-PV Energy Sales Forecasts

Table J-6 depicts the difference between our initial input assumptions and those assumed by Ulupono as a result of their suggested changes. Note that these Ulupono amounts are projected, and not necessarily the results of the revised NREL resource potential study.

Resources (MW)	Hawaiian Electric	Ulupono (Dr. Fripp)	Maui Electric	Hawai'i Electric Light
Onshore Grid-Scale PV	2,756	6,583	783	30,484
Onshore Market DG-PV	1,308	n/a	206	184
Onshore High DG-PV	2,101	3,022	450	456
Onshore Grid-Scale Wind	162	2,680	840	3,532
Offshore Grid-Scale Wind	800	800	n/a	n/a

Table J-6. Renewable Energy Resource Potential

**Underlying Forecast.** The underlying forecast incorporates projections for key drivers of the economy prepared by the University of Hawai'i Economic Research Organization (UHERO) in April 2015 such as job counts, personal income and resident population. Electricity price and weather variables are also included in the models.

**Energy Efficiency.** The preliminary projections for impacts associated with energy efficiency measures over the next five to ten years were assumed to be consistent with historical average annual impacts achieved by the Public Benefits Fund Administrator, Hawai'i Energy. In addition to the impacts from Hawai'i Energy's programs, changes to building and manufacturing codes and standards would be integrated into the marketplace over time contributing to market transformation. Collectively, these changes would support energy efficiency impacts growing at a faster pace in order to meet the longer term energy efficiency goal in 2030 (expressed in GWh). This pace is identified in the framework that governs the achievement of Energy Efficiency Portfolio Standards (EEPS) in the State of Hawai'i as prescribed in Hawai'i Revised Statutes § 269-96, and set by the Commission in Decision and Order No. 30089 in Docket No. 2010-0037. It was assumed the 30% sales reduction goal would continue beyond 2030. These projections did not consider participation in DR programs. DR program participation is taken into consideration in later steps of the analysis process.

To determine the peak demand savings from energy efficiency, an average annual ratio between historical efficiency sales and peak impacts was applied to the projected annual energy impacts.

There is a significant uncertainty regarding the degree customers will engage in the adoption of energy efficiency measures, building practices and participation in DR programs. This will have a direct impact on projected sales and peak demand levels. If customer adoption is lower than projected, then demand for energy could exceed the forecasted levels and conversely, higher than projected would lower customer demand for

energy. Over the 30-year planning period, participation may be higher or lower than the forecast depending on factors such as customer preferences, general economic conditions and availability of affordable technology. Although all future unknowns cannot be identified, the Company will work together with Hawai'i Energy to develop alternative energy efficiency forecasts to better understand and address potential uncertainties.

**Distributed Generation.** In support of the December 2016 updated PSIP, an iteration of the DER optimization cycle was completed. The projections for impacts associated with distributed generation photovoltaic (DG-PV) systems installed under the Company's tariffed programs (legacy NEM, SIA, grid-supply to cap, self-supply and potential future grid-supply) were developed separately by program for residential and commercial customers and aggregated into an overall forecast for DG-PV systems. For the self-supply portion of the forecasts, residential and small commercial DG-PV systems were paired with distributed energy storage systems (DESS). The paired DG-PV and DESS system sizes were based on optimal customer economics determined by maximizing the NPV of the customer investment via the Boston Consulting Group ("BCG") customer adoption model. Residential and some small commercial load shapes on average have relatively lower daytime load and higher evening loads. Therefore in a self-supply program the use of a DESS allows them to self-generate a much larger portion of their energy needs than they would be able to otherwise if their PV system size was limited to not exceed their daytime load. Larger commercial customers on average have larger daytime loads that enable them to benefit significantly from a self-supply program without the need to invest in DESS. Additional stand-alone DESS, not necessarily paired with PV, were projected to participate in Demand Response programs since it is possible for customers and the grid to benefit from stand-alone DESS as well.

In the near term (through 2018) assumptions based on recent historical activity and known projects were made regarding the timing of system installations associated with the remaining applications in the legacy NEM queue, Customer Grid Supply up to the cap, and near term SIA projections. For additional future quantities of self-supply, SIA and potential future grid-supply DG-PV systems, the Company used a customer adoption model developed by BCG. The model examines the relationship between economics and adoption of DG-PV and DG-PV with DESS based on payback time, net present value (NPV) and internal rate of return (IRR) from the customer's perspective. For the potential future grid-supply program, it was assumed that energy exported to the grid would be compensated at utility-scale PV LCOE.

Figure J-10 through Figure J-14 depicts the market DG-PV forecasts for O'ahu, Hawai'i Island, Maui, Lanai, and Molokai developed to support the December 2016 PSIP update. Table J-15 through Table J-19 depicts the customer self-supply DESS forecasts for the respective islands. Data corresponding to the DESS forecast figures are detailed in Table J-27 through Table J-31.

## J. Modeling Assumptions Data

Energy Sales and Peak Demand Forecast

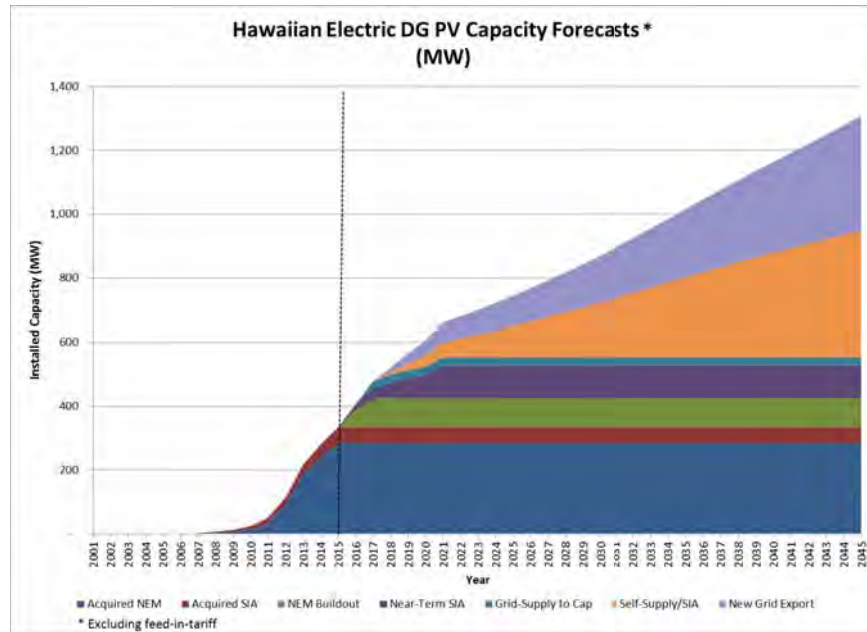

Figure J-10. O'ahu Market DG-PV Capacity Forecasts

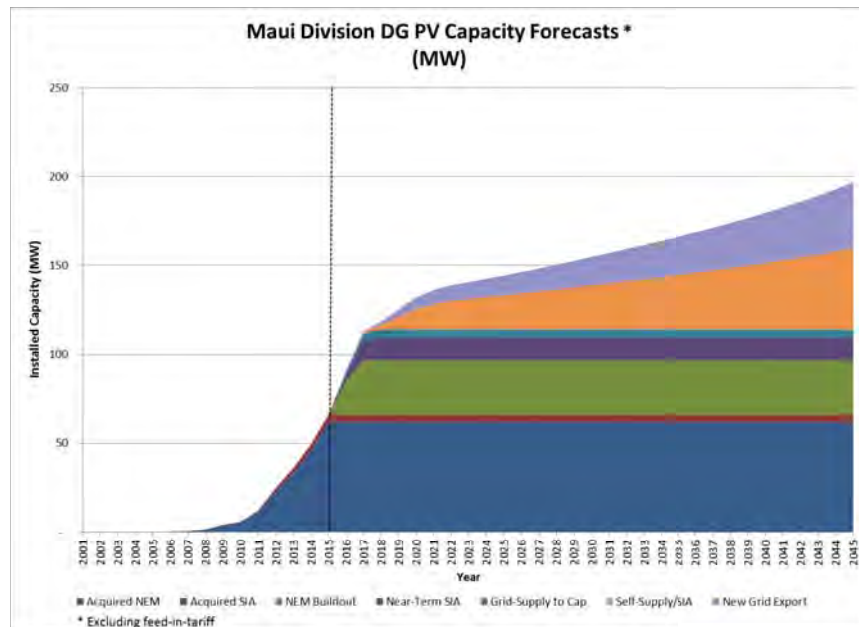

Figure J-11. Maui Island Market DG-PV Capacity Forecasts

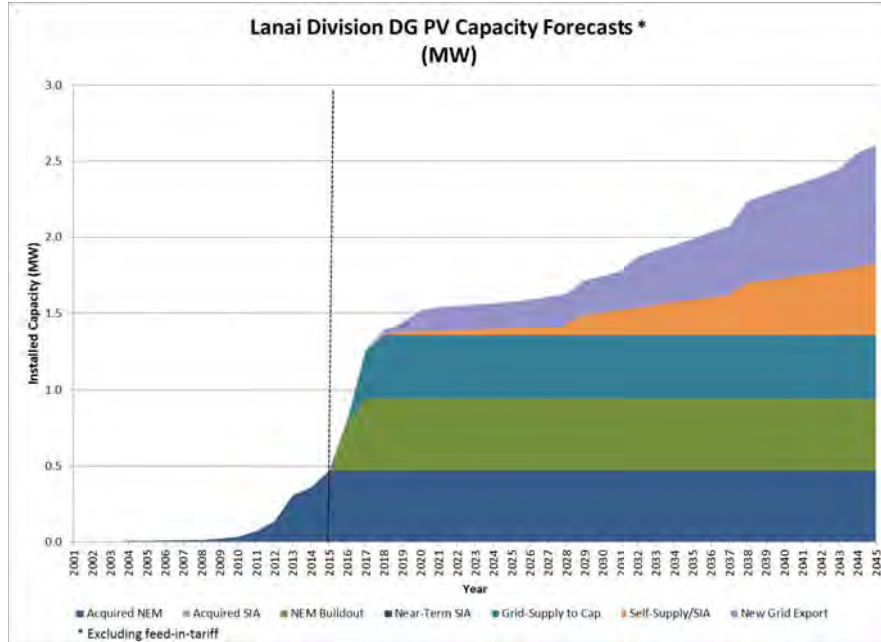

Figure J-12. Lana'i Market DG-PV Capacity Forecasts

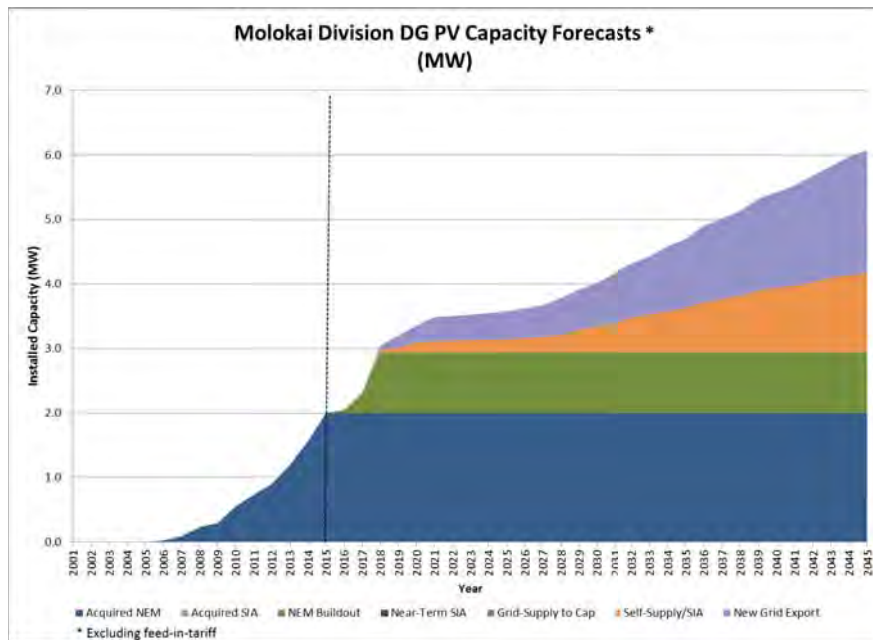

Figure J-13. Moloka'i Market DG-PV Capacity Forecasts

## J. Modeling Assumptions Data

Energy Sales and Peak Demand Forecast

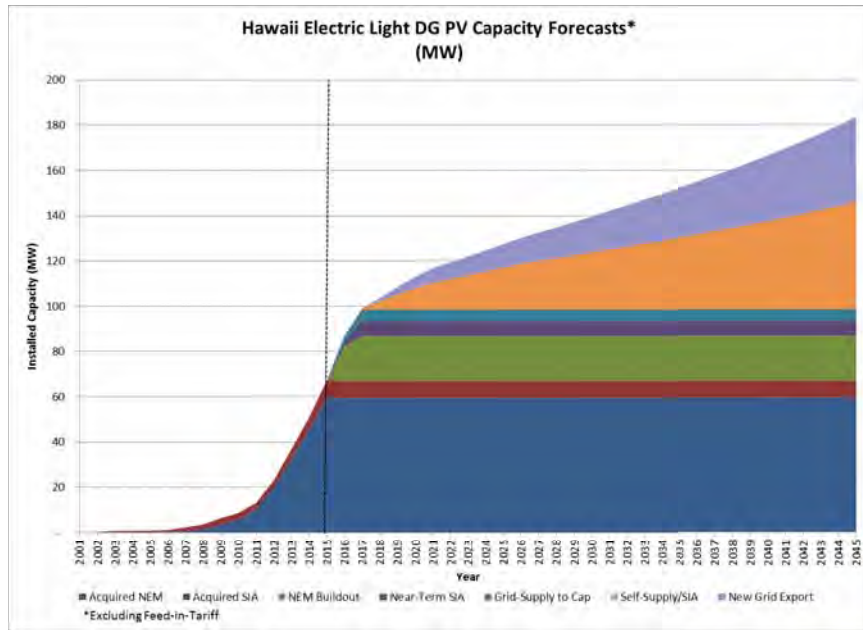

Figure J-14. Hawai'i Island Market DG-PV Capacity Forecasts

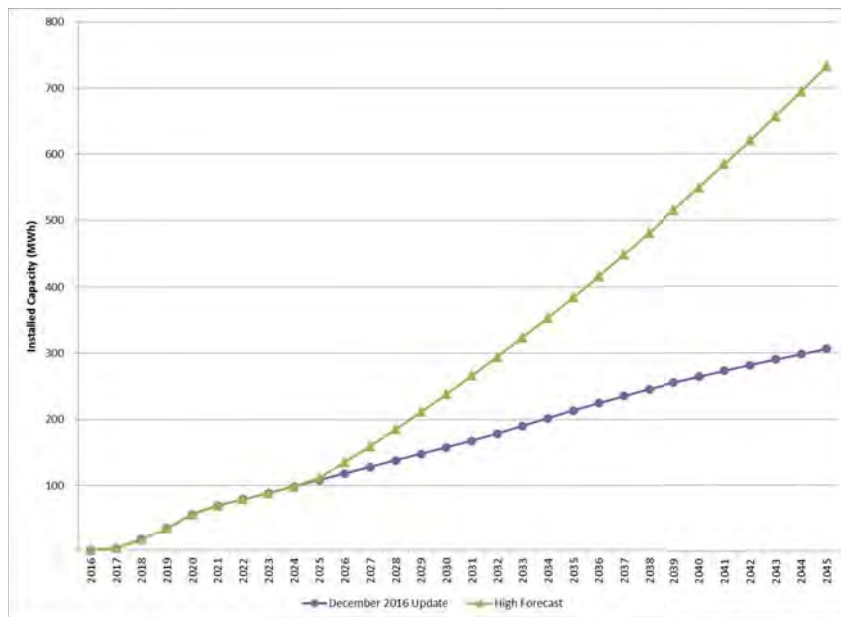

Figure J-15. O'ahu Market Self-Supply DESS Capacity Forecasts

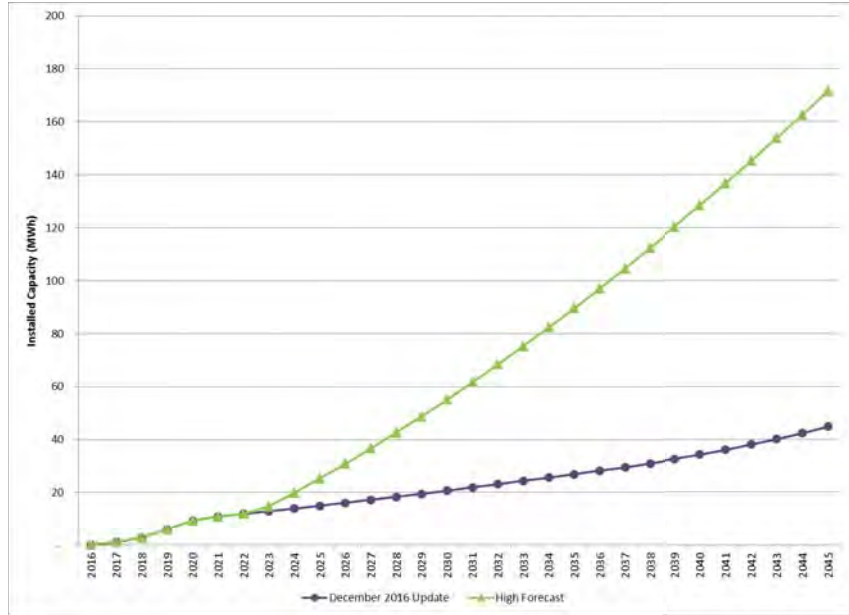

Figure J-16. Maui Market Self-Supply DESS Capacity Forecasts

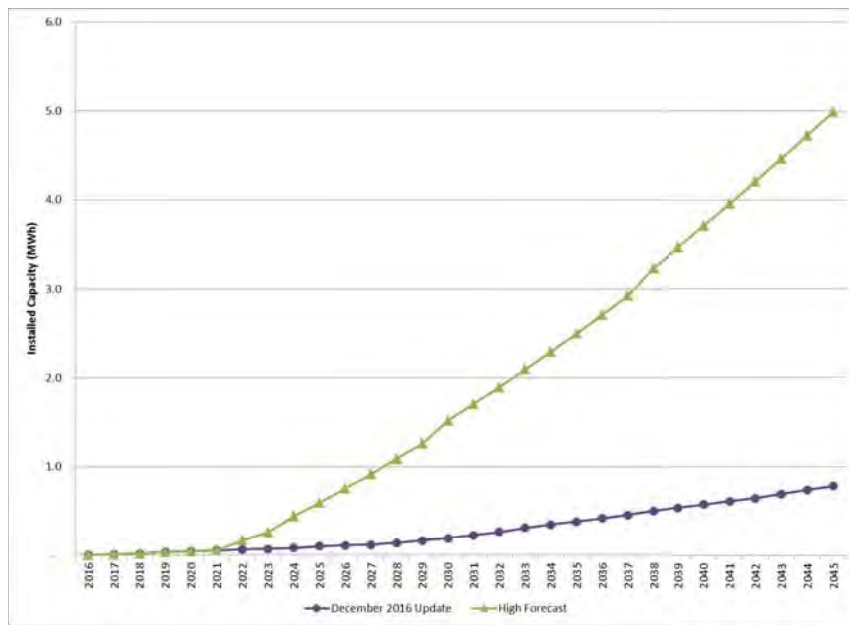

Figure J-17. Lana'i Market Self-Supply DESS Capacity Forecasts



## J. Modeling Assumptions Data

### Energy Sales and Peak Demand Forecast

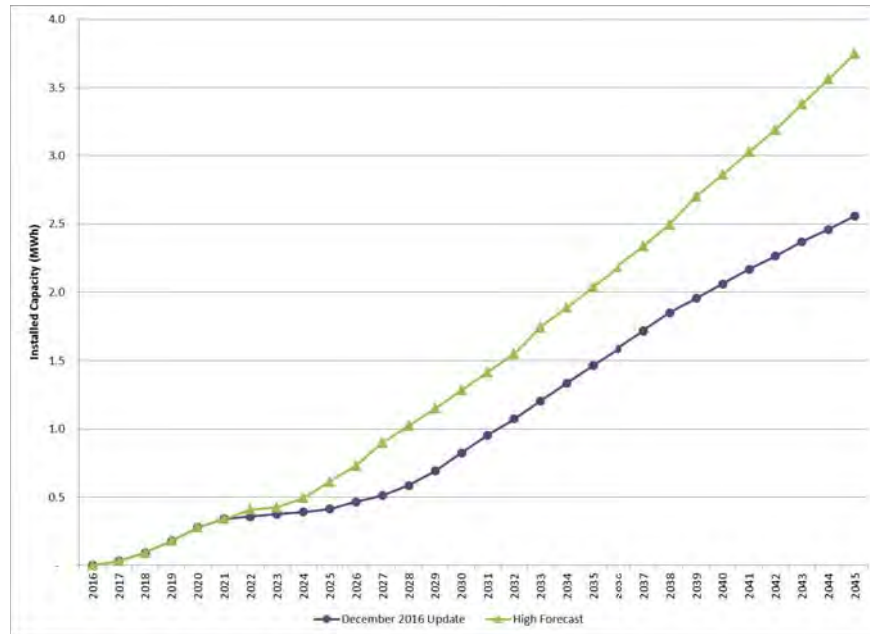

Figure J-18. Moloka'i Market Self-Supply DESS Capacity Forecasts

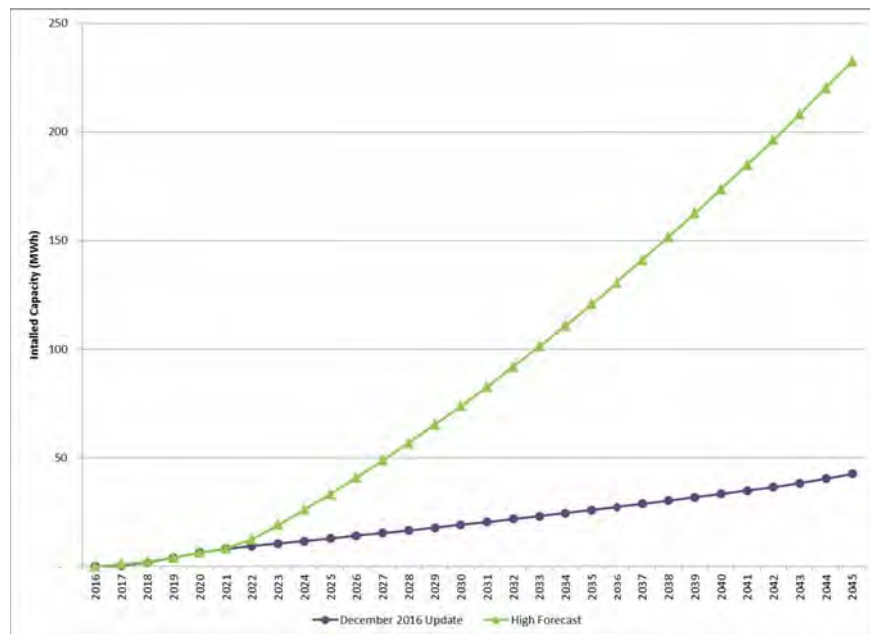

Figure J-19. Hawai'i Island Market Self-Supply DESS Capacity Forecasts

### High DG-PV Market Potential

The high DG-PV market potential forecast scenario was also updated to include DESS paired with self-supply PV systems. For the residential customers the Company assumed that 100% of the single-family residential electricity sales would be offset by DG-PV by 2045. The Company assumed that it was unlikely to offset 100% of the commercial

customers' load given the amount of rooftop space required and challenges arising from property ownership, and therefore focused on business sectors that currently participate or are likely to participate in a Company program. Roughly, 20-25% of the total commercial sales would be offset by DG-PV in 2045 for all islands with the exception of Lanai (7%) which has fairly low participation to date.

The Company recognized that reaching the high DG-PV market potential by 2045 still required projections that reflect achievable near term potentials before taking off on the path to 2045. There is lead-time involved when standing up new programs, financial incentives and/or the development and deployment of technology solutions. As such, the Company used similar projections of total PV and DESS capacity as the market DG-PV forecast in the near term before ramping up to the high DG-PV market potential. It was also assumed that under the high DG-PV market potential scenario, all residential, small and medium commercial customers would require a DESS for systems installed under the self-supply program since their daytime loads on average may be lower than their evening loads. Therefore in a self-supply program the use of a DESS allows them to self-generate a much larger portion of their energy needs than they would be able to otherwise if their PV system size was limited to not exceed their daytime load. The larger commercial customers on average have larger daytime loads that enable them to benefit significantly from a self-supply program without the need to invest in DESS.

The forecast was not done from a maximum rooftop potential perspective and did not consider whether it was cost effective from a customer or system level perspective. To achieve this higher level of DG-PV and DESS adoption will likely require mandates or significant additional customer incentives.

The Company is continuing efforts to estimate the technical potential for rooftop DG-PV through discussions with companies such as Google and Mapdwell that are developing tools to address this question. More details on the Google and Mapdwell opportunities are described in Appendix H: Renewable Resource Options for O'ahu.

See Figure J-20 through Figure J-24 for a comparison between four DG-PV forecasts used in the 2016 PSIP updates. Data corresponding to the DG-PV forecast figures are detailed in Table J-22 through Table J-26.

## J. Modeling Assumptions Data

### Energy Sales and Peak Demand Forecast

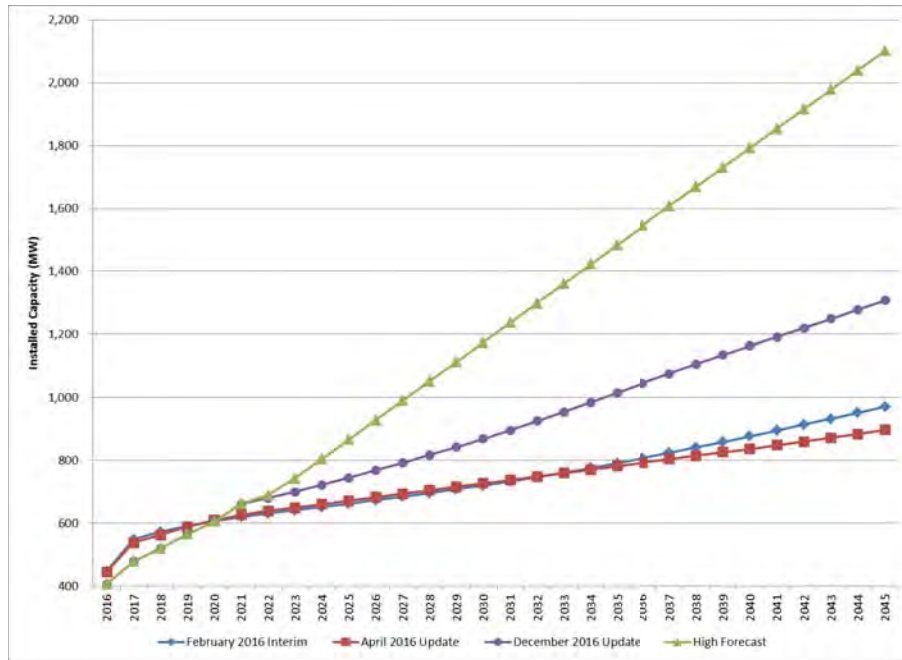

Figure J-20. O'ahu DG-PV Capacity Forecast Comparison

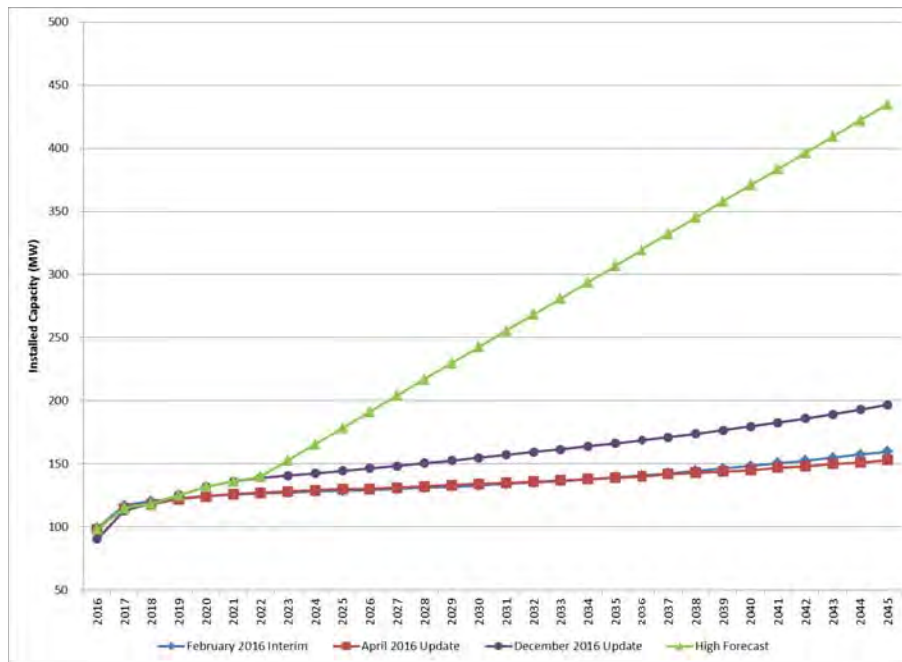

Figure J-21. Maui Island DG-PV Capacity Forecast Comparison

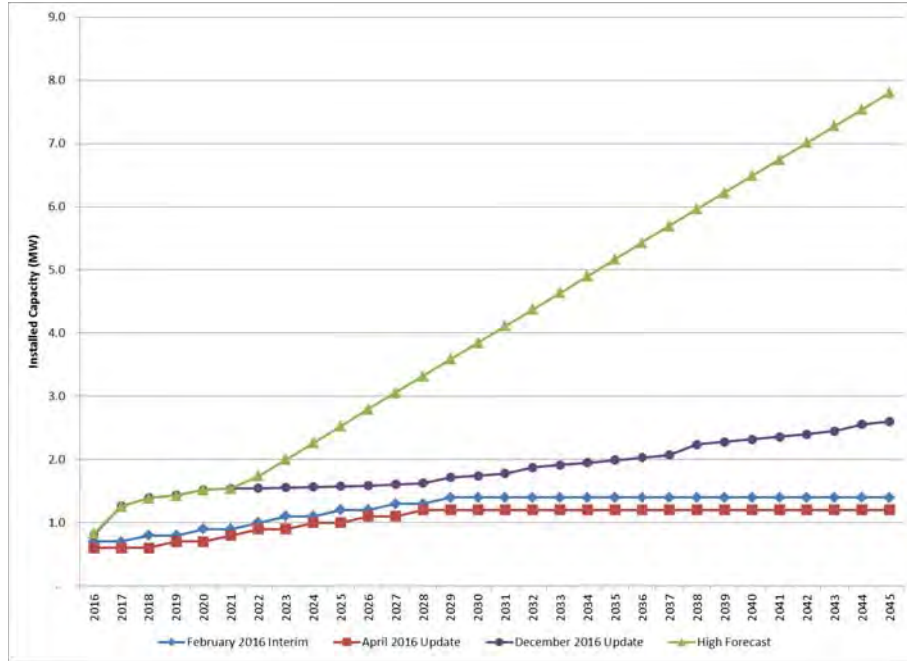

Figure J-22. Lana'i Island DG-PV Capacity Forecast Comparison

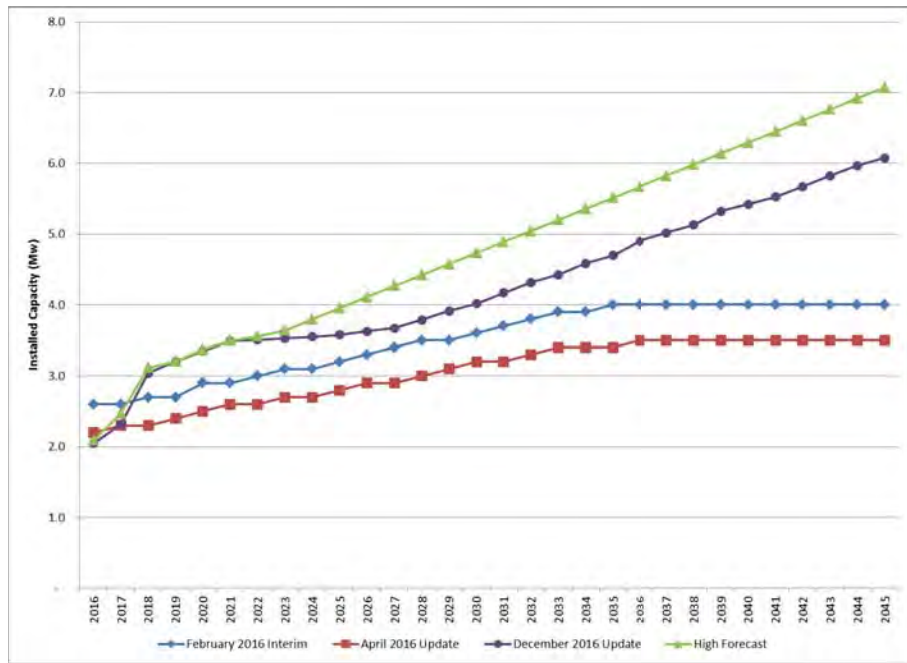

Figure J-23. Moloka'i Island DG-PV Capacity Forecast Comparison

## J. Modeling Assumptions Data

### Energy Sales and Peak Demand Forecast

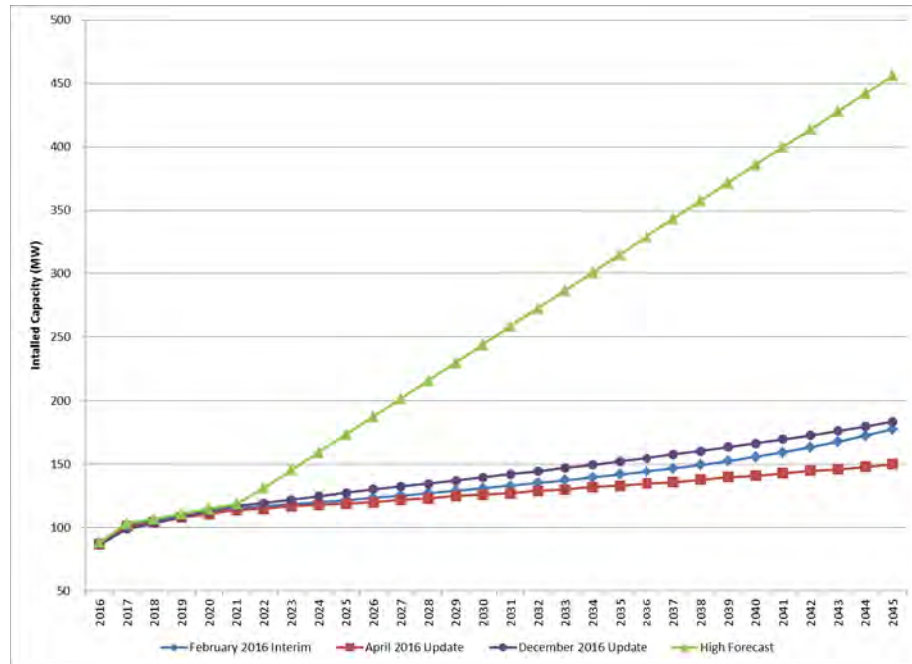

Figure J-24. Hawai'i Island DG-PV Capacity Forecast Comparison

**Electric Vehicles.** The development of the electric vehicles forecast was based on estimating the number of electric vehicles purchased per year using a historical average annual growth rate then multiplying by an estimate of the annual energy used per vehicle. The annual energy used per vehicle was based on the average miles driven per year as stated in the Hawai'i Data Book multiplied by the energy required per mile averaged over a 2015 Nissan Leaf, Chevy Volt, Chevy Spark, and Tesla Model S.

### Peak Demand Forecast

The peak demand forecast was derived using Itron's proprietary modeling software, MetrixLT. The software utilizes load profiles by rate schedule from class load studies conducted by the Company and the underlying sales forecast derived by rate schedule. The rate schedule load profiles adjusted for forecasted sales are aggregated to produce system profiles. The Company employed the highest system demands to calculate the underlying annual system. After determining the underlying peak forecast, the Company made adjustments that were outside of the underlying forecasts, for example impacts from energy efficiency measures. No adjustments were made to the underlying system peak forecast for DG-PV or electric vehicles as forecasted system peaks are expected to occur during the evening.

The underlying peak forecast for Lana'i and Moloka'i Divisions were derived by employing a sales load factor method which compares the annual sales in MWh against the peak load in MW multiplied by the number of hours during the year.

The peak demands of each operating company forecasted through the study period expressed at the net generation level are in Figure J-25 through Figure J-29 and do not include the impacts of customers’ distributed storage systems or the effects of DR programs on the peaks. Behind the meter DESS impacts to evening peaks are accounted for in the DR peak reduction impacts to allow optimization of the use of the resources and to avoid the possibility of double-counting the impacts. Inclusion of the DESS impacts in the DR analysis allows the DR modeling to potentially increase the value of these DESS resources by incenting DESS energy outflow based on grid system needs, which may differ from the customer’s native usage profile. Data for the peak forecast projections are detailed in Table J-12 through Table J-16.

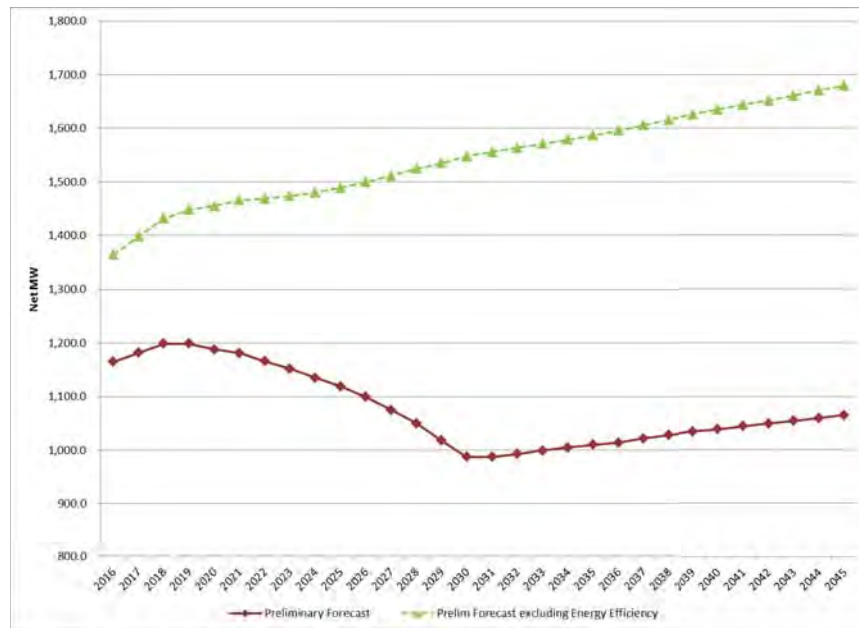

Figure J-25. O’ahu Generation Level Peak Demand

## J. Modeling Assumptions Data

Energy Sales and Peak Demand Forecast

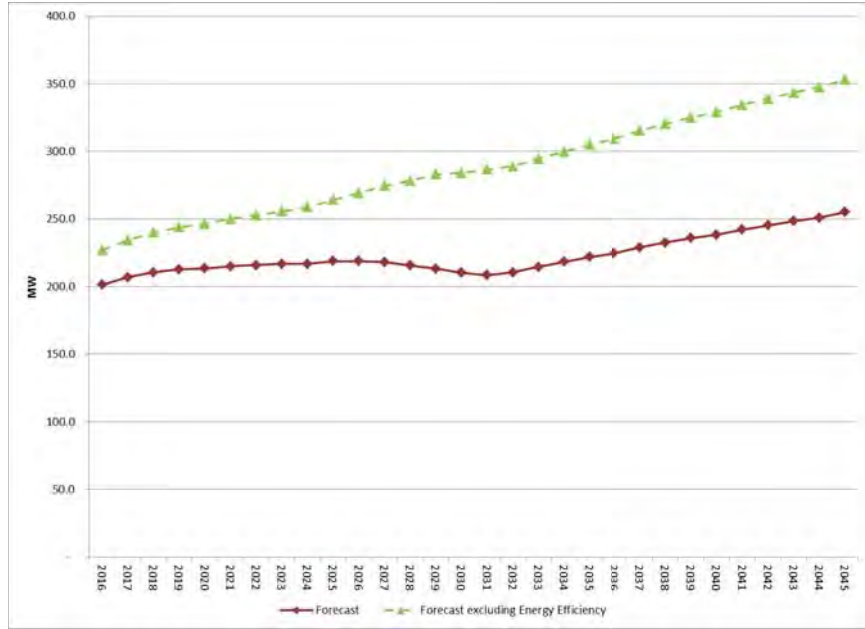

Figure J-26. Maui Island Generation Level Peak Demand

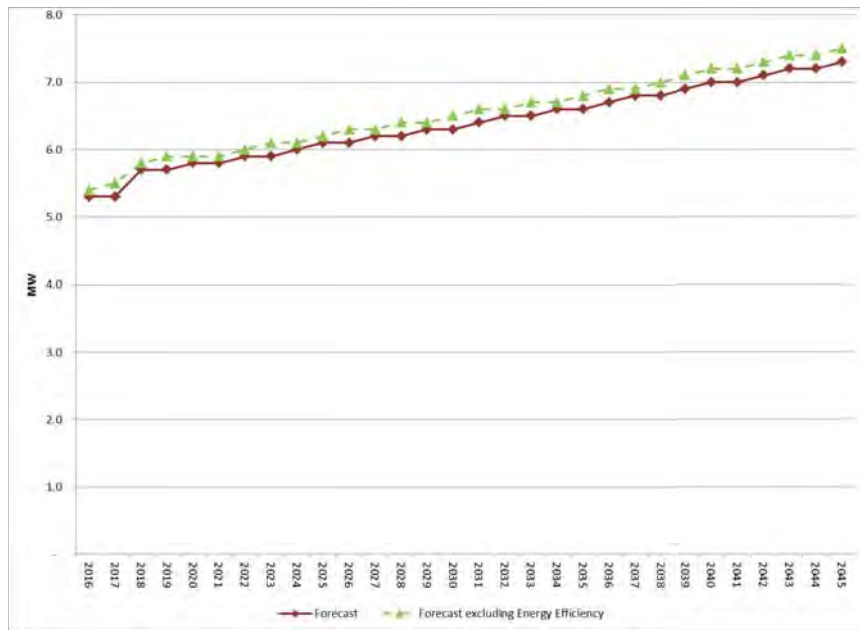

Figure J-27. Lana'i Generation Level Peak Demand

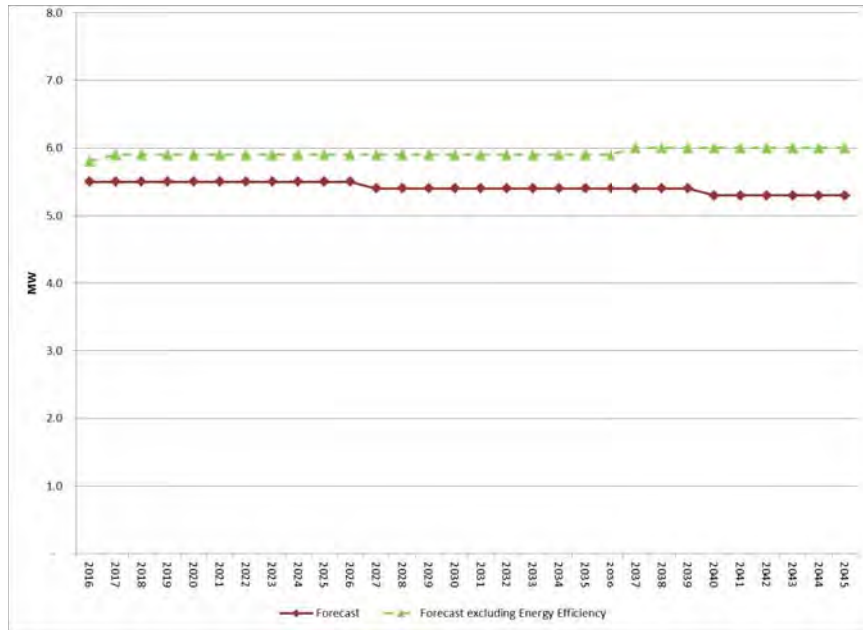

Figure J-28. Moloka'i Generation Level Peak Demand

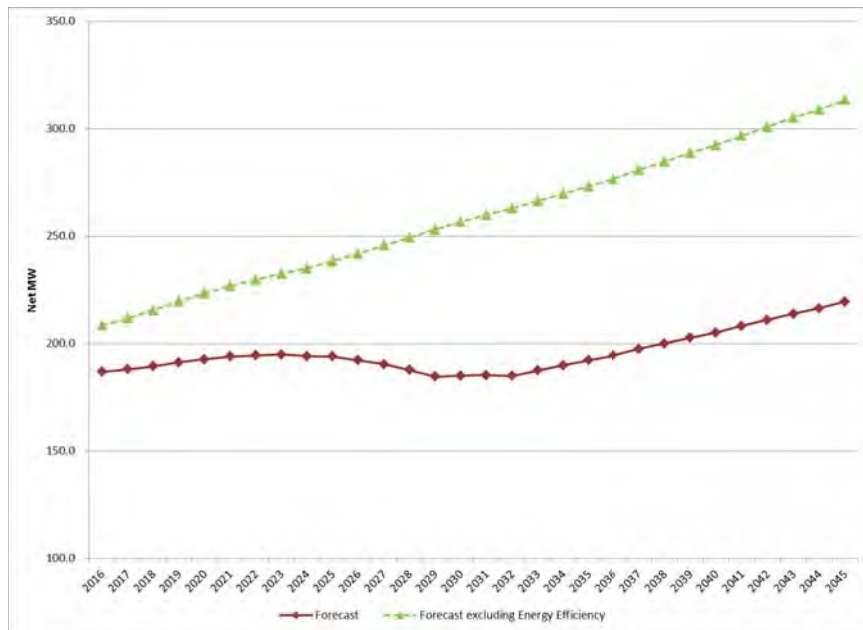

Figure J-29. Hawai'i Island Generation Level Peak Demand



## J. Modeling Assumptions Data

### Energy Sales and Peak Demand Forecast

#### Comparison to the April 2016 PSIP Update Forecast

The forecasts used in this December 2016 update differ from the April 2016 update only in the amount of sales offset by customer-sited DG-PV generation due to the updated DG-PV forecasts (Table J-17 and Table J-21).

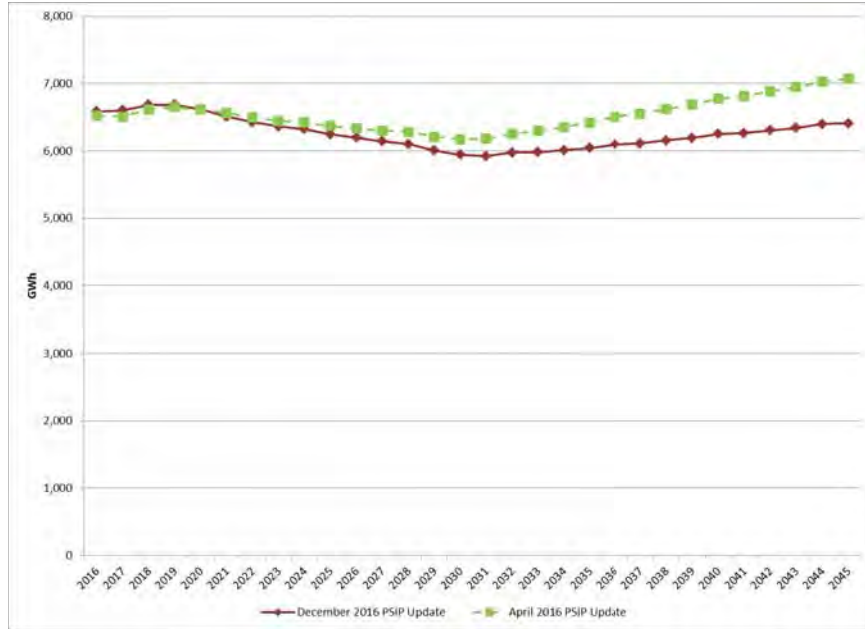

Figure J-30. O'ahu Sales Forecast Comparison

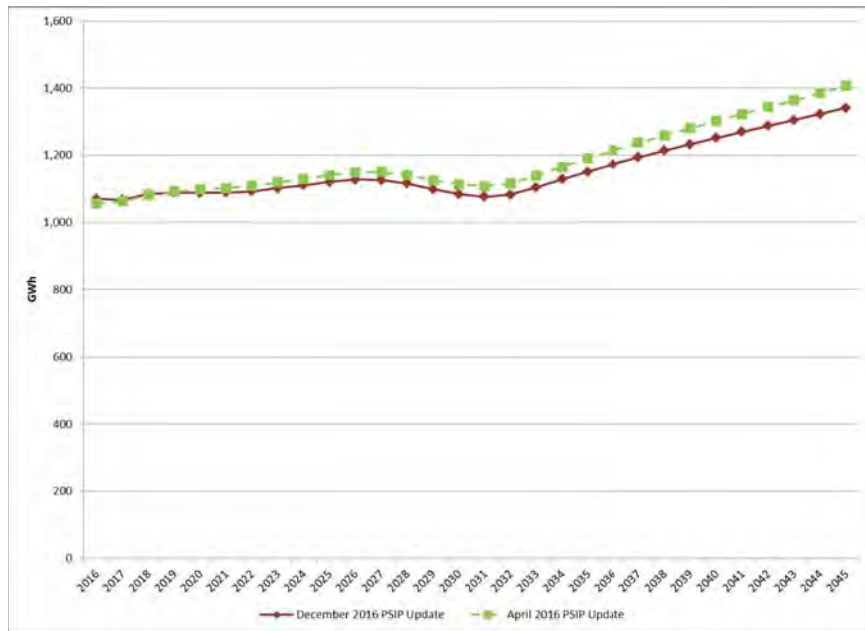

Figure J-31. Maui Island Sales Forecast Comparison

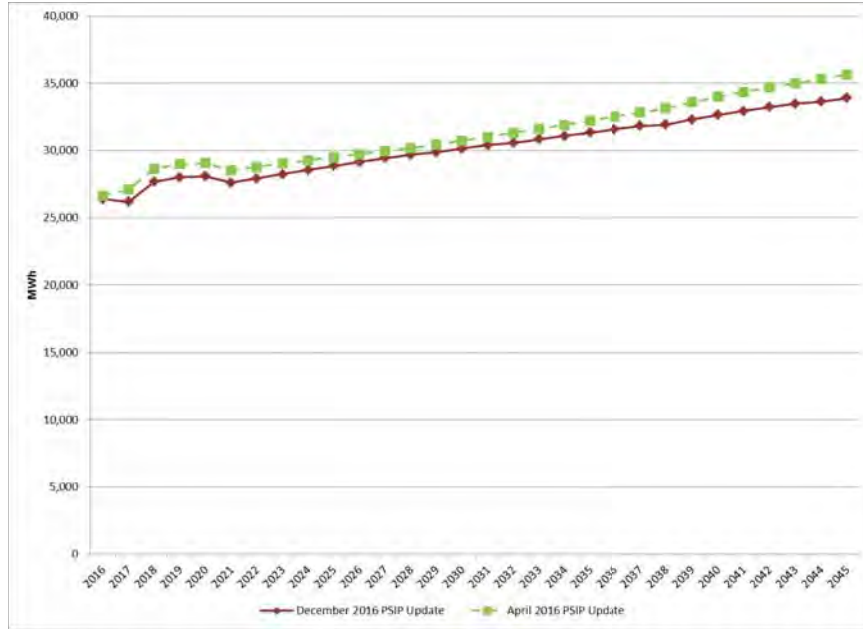

Figure J-32. Lana'i Sales Forecast Comparison

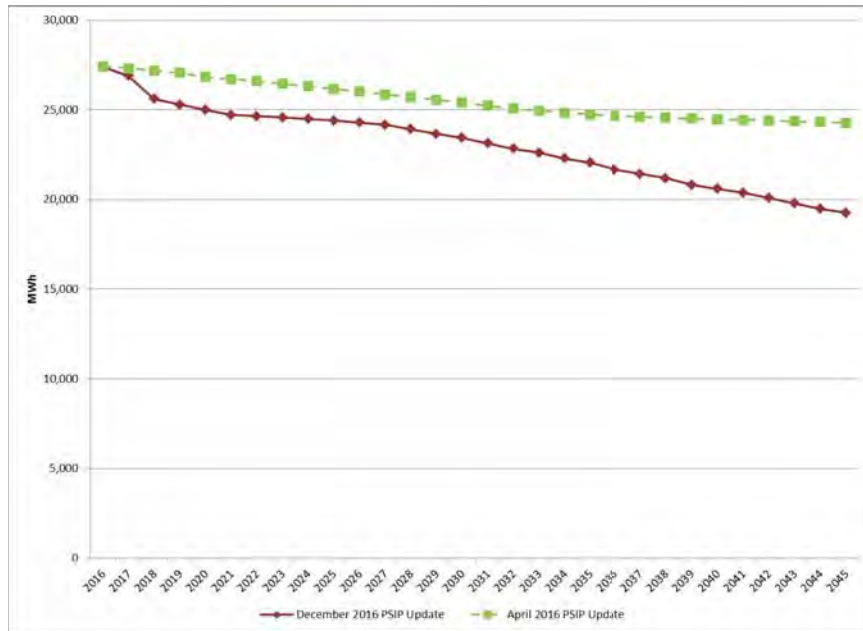

Figure J-33. Moloka'i Sales Forecast Comparison

## J. Modeling Assumptions Data

### Energy Sales and Peak Demand Forecast

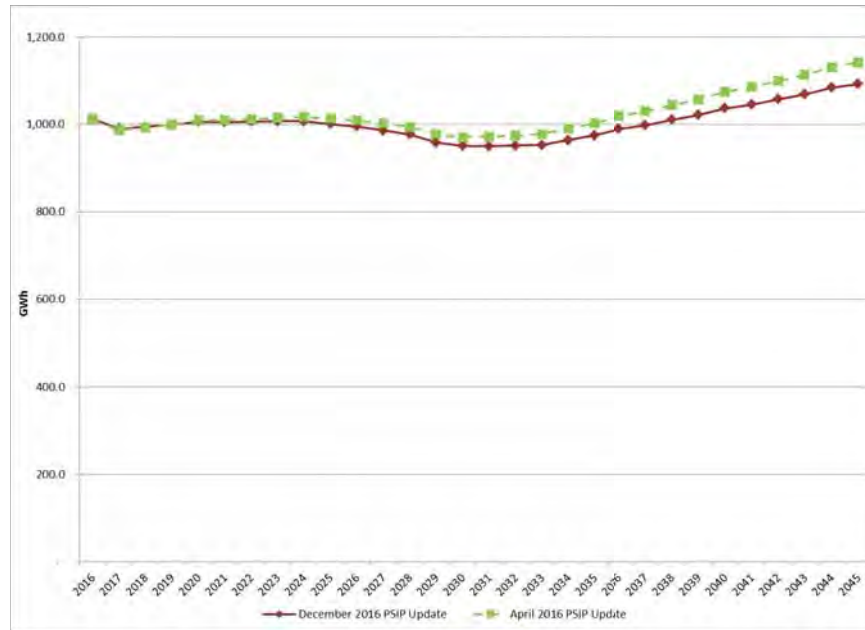

Figure J-34. Hawai'i Island Sales Forecast Comparison

See Table J-17 through Table J-21 for the detailed sales comparison between the sales forecasts used for the December 2016 PSIP update and the April 2016 PSIP update.

Note that the peak forecasts were developed using the method described in the prior page. There is no change to the peak forecasts since the April 2016 PSIP update. Self-supply program DESS energy outflows can reduce the peak loads in the future, however for reasons explained earlier those impacts are reflected in the DR impacts rather than the peak forecast.

### UHERO’s Economic Forecasts

UHERO’s forecasts for non-farm jobs, personal income, and visitor arrivals were used in developing the sales forecasts. Figure J-35 through Figure J-37 compare the economic forecasts developed by UHERO in 2015 against the forecast developed in 2014, illustrating the less optimistic outlook between the two forecasts. See also Table J-32 through Table J-34 for a comparison between UHERO’s April 2014 and April 2015 economic forecasts.

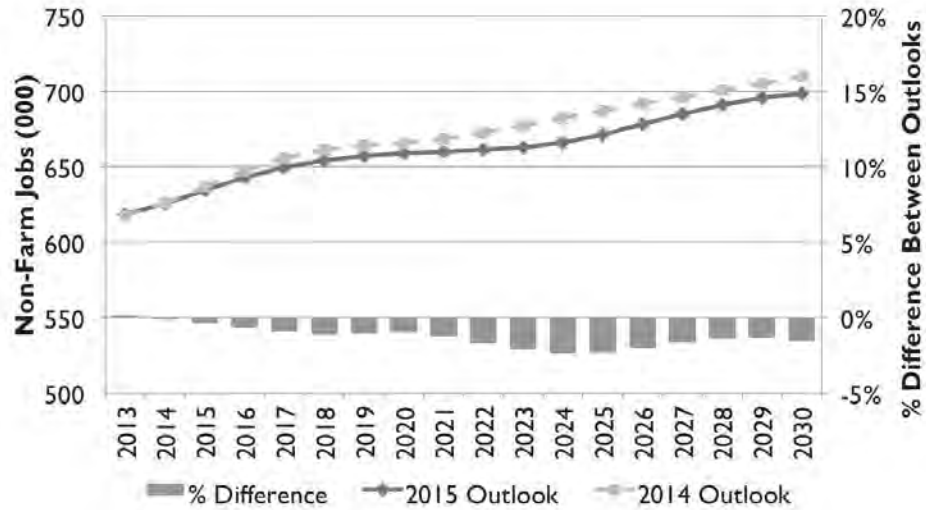

Figure J-35. Hawai'i Non-Farm Job Count Forecast Comparison

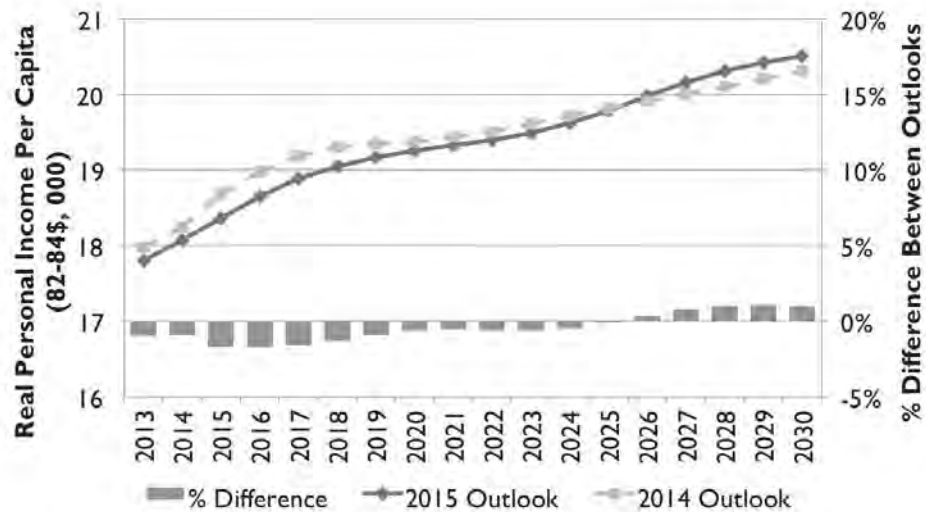

Figure J-36. Hawai'i Real Personal Income per Capita Forecast Comparison

## J. Modeling Assumptions Data

Energy Sales and Peak Demand Forecast

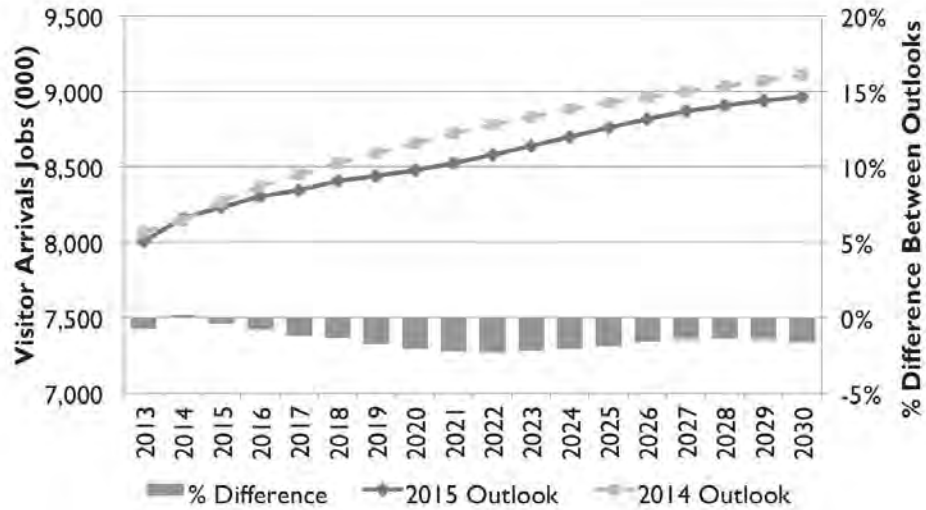

Figure J-37. Hawai'i Visitor Arrival Forecast Comparison

### Load Profiles

Available generating resources must be able to meet a demand profile over a period of time that doesn't include customer-sited distributed generation. Our analysis used a demand profile in two ways:

- An annual hourly load profile (8,760 data points: 365 days at 24 hours a day).
- A sub-hourly load profile data, which model intra-hour issues associated with ramping of generating resources and energy storage in response to variable renewable generation.

Because of the proliferation of customer-sited distributed generation, the net load profile has changed dramatically over the past few years. Our analysis assumed a system gross load profile. The model includes the profile of customer-sited distributed generation, which results in the net load to be served.

### Sub-Hourly Profile

Black & Veatch has developed sub-hourly profiles for variable generation that includes rooftop solar panels, and utility-scale solar and wind. These profiles form the backbone for evaluating the impacts of variable generation and the fleet’s ability to meet demand.

Black & Veatch’s model is based on historical changes in minute-to-minute generation by asset type and island. Using historical data, the model creates a probability distribution function based on time of day and current generation levels. The probability, then, is a distribution of all the possible changes in demand for an asset type. Combining this probability with random number generation results in the change in output for the next time step for that asset.

The model “fills in” the sub-hourly generation of each asset in between the hourly generation profiles provided by the Hawaiian Electric planning group. Black & Veatch’s model ensures that energy production over each day with the sub-hourly profiles matches the production from the hourly model. This daily energy matching aligns total production with models that employ only hourly data.

The difference between the modeling data for sub-hourly versus hourly is dramatic. Figure J-38 depicts an example day of an hourly profile on the Hawaiian Electric grid and the output profile from the Black & Veatch model.

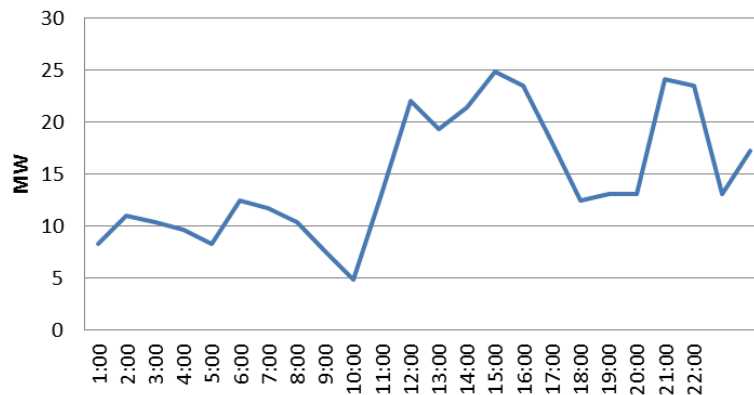

Figure J-38. Wind Unit Day Hourly Profile Example

**J. Modeling Assumptions Data**

Energy Sales and Peak Demand Forecast

Figure J-39 depicts an example day of an hourly profile on the Hawaiian Electric grid and the output profile from the Black & Veatch model.

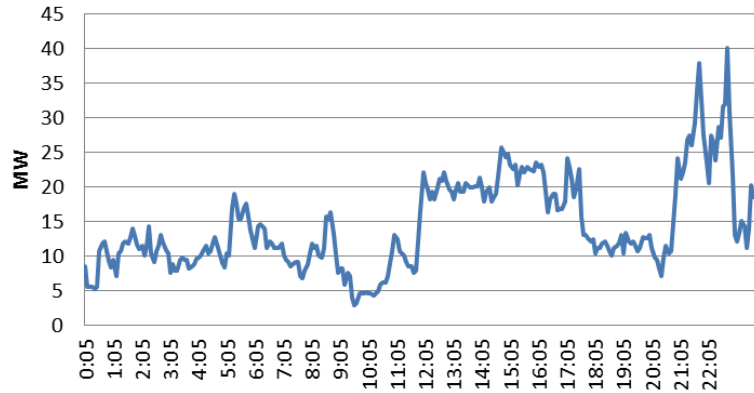

Figure J-39. Wind Unit Day Sub-Hourly Profile Example



## SALES FORECASTS

## O'ahu Customer Level Sales Forecast

GWh	Underlying Forecast	Energy Efficiency	DG-PV	Electric Vehicles	Customer Level Sales Forecast
Year	a	b	c	d	e = a + b + c + d
2016	8,286	(1,077)	(656)	31	6,585
2017	8,481	(1,149)	(772)	42	6,602
2018	8,691	(1,224)	(839)	55	6,684
2019	8,817	(1,288)	(912)	69	6,686
2020	8,886	(1,375)	(977)	86	6,620
2021	8,933	(1,466)	(1,067)	106	6,507
2022	8,953	(1,557)	(1,097)	129	6,428
2023	8,987	(1,647)	(1,129)	153	6,363
2024	9,054	(1,744)	(1,164)	179	6,325
2025	9,087	(1,846)	(1,201)	207	6,247
2026	9,154	(1,957)	(1,239)	236	6,194
2027	9,230	(2,080)	(1,277)	267	6,140
2028	9,329	(2,209)	(1,317)	300	6,103
2029	9,377	(2,346)	(1,358)	334	6,007
2030	9,460	(2,486)	(1,400)	370	5,944
2031	9,513	(2,553)	(1,445)	407	5,923
2032	9,581	(2,561)	(1,491)	444	5,973
2033	9,605	(2,568)	(1,539)	482	5,981
2034	9,652	(2,574)	(1,588)	521	6,011
2035	9,704	(2,584)	(1,637)	560	6,042
2036	9,785	(2,601)	(1,686)	599	6,097
2037	9,823	(2,615)	(1,735)	639	6,112
2038	9,886	(2,628)	(1,783)	679	6,154
2039	9,947	(2,644)	(1,830)	719	6,192
2040	10,032	(2,665)	(1,875)	759	6,250
2041	10,066	(2,680)	(1,921)	799	6,264
2042	10,122	(2,692)	(1,966)	841	6,305
2043	10,178	(2,707)	(2,013)	883	6,342
2044	10,257	(2,726)	(2,060)	927	6,397
2045	10,288	(2,741)	(2,108)	971	6,409

Table J-7. O'ahu Customer Level Sales Forecast



## J. Modeling Assumptions Data

Sales Forecasts

### Maui Island Customer Level Sales Forecast

GWh	Underlying Forecast	Energy Efficiency	DG-PV	Electric Vehicles	Customer Level Sales Forecast
Year	a	b	c	d	$e = a + b + c + d$
2016	1,351	(142)	(141)	2	1,070
2017	1,392	(152)	(176)	3	1,067
2018	1,426	(163)	(185)	5	1,084
2019	1,450	(173)	(195)	7	1,089
2020	1,468	(183)	(206)	9	1,088
2021	1,483	(194)	(212)	12	1,089
2022	1,499	(204)	(217)	14	1,093
2023	1,518	(214)	(219)	17	1,102
2024	1,541	(229)	(222)	21	1,110
2025	1,568	(247)	(225)	24	1,121
2026	1,599	(270)	(228)	28	1,127
2027	1,626	(301)	(231)	32	1,126
2028	1,649	(334)	(235)	35	1,116
2029	1,668	(371)	(238)	39	1,099
2030	1,684	(401)	(242)	43	1,084
2031	1,698	(424)	(245)	47	1,076
2032	1,717	(437)	(249)	51	1,082
2033	1,743	(442)	(252)	55	1,104
2034	1,775	(450)	(256)	59	1,128
2035	1,805	(458)	(259)	63	1,151
2036	1,835	(467)	(263)	67	1,173
2037	1,865	(476)	(267)	72	1,194
2038	1,893	(484)	(271)	76	1,214
2039	1,920	(492)	(275)	80	1,233
2040	1,948	(500)	(280)	85	1,252
2041	1,974	(508)	(285)	89	1,270
2042	2,000	(516)	(290)	94	1,288
2043	2,026	(524)	(295)	98	1,305
2044	2,053	(532)	(301)	103	1,323
2045	2,080	(540)	(307)	108	1,341

Table J-8. Maui Island Customer Level Sales Forecast

## Lana'i Customer Level Sales Forecast

MWh	Underlying Forecast	Energy Efficiency	DG-PV	Electric Vehicles	Customer Level Sales Forecast
Year	a	b	c	d	e = a + b + c + d
2016	28,114	(585)	(1,150)	–	26,379
2017	28,596	(602)	(1,805)	–	26,189
2018	30,273	(618)	(1,988)	–	27,666
2019	30,701	(635)	(2,045)	–	28,021
2020	30,910	(652)	(2,171)	–	28,087
2021	30,472	(668)	(2,200)	–	27,604
2022	30,811	(685)	(2,211)	–	27,915
2023	31,158	(702)	(2,222)	–	28,234
2024	31,510	(719)	(2,234)	–	28,558
2025	31,846	(735)	(2,251)	–	28,860
2026	32,169	(752)	(2,268)	–	29,149
2027	32,493	(769)	(2,297)	–	29,428
2028	32,801	(785)	(2,325)	–	29,691
2029	33,122	(802)	(2,451)	–	29,869
2030	33,449	(819)	(2,491)	–	30,140
2031	33,771	(835)	(2,537)	–	30,398
2032	34,102	(852)	(2,674)	–	30,577
2033	34,438	(869)	(2,731)	–	30,838
2034	34,753	(885)	(2,782)	–	31,085
2035	35,076	(902)	(2,839)	–	31,335
2036	35,409	(919)	(2,902)	–	31,589
2037	35,731	(935)	(2,959)	–	31,837
2038	36,062	(952)	(3,193)	–	31,917
2039	36,539	(969)	(3,256)	–	32,314
2040	36,949	(985)	(3,313)	–	32,651
2041	37,319	(1,002)	(3,370)	–	32,947
2042	37,676	(1,019)	(3,428)	–	33,229
2043	38,008	(1,035)	(3,496)	–	33,476
2044	38,348	(1,052)	(3,650)	–	33,646
2045	38,690	(1,069)	(3,719)	–	33,902

Table J-9. Lana'i Customer Level Sales Forecast

## J. Modeling Assumptions Data

Sales Forecasts

### Moloka'i Customer Level Sales Forecast

MWh	Underlying Forecast	Energy Efficiency	DG-PV	Electric Vehicles	Customer Level Sales Forecast
Year	a	b	c	d	e = a + b + c + d
2016	32,779	(1,829)	(3,550)	–	27,400
2017	32,810	(1,896)	(4,015)	–	26,899
2018	32,837	(1,963)	(5,270)	–	25,604
2019	32,864	(2,030)	(5,545)	–	25,289
2020	32,891	(2,097)	(5,808)	–	24,986
2021	32,918	(2,164)	(6,042)	–	24,712
2022	32,945	(2,231)	(6,068)	–	24,646
2023	32,972	(2,298)	(6,106)	–	24,568
2024	32,999	(2,365)	(6,148)	–	24,486
2025	33,027	(2,433)	(6,195)	–	24,399
2026	33,052	(2,500)	(6,276)	–	24,277
2027	33,078	(2,567)	(6,354)	–	24,158
2028	33,104	(2,634)	(6,557)	–	23,913
2029	33,130	(2,701)	(6,777)	–	23,652
2030	33,156	(2,768)	(6,957)	–	23,431
2031	33,182	(2,835)	(7,224)	–	23,123
2032	33,208	(2,902)	(7,480)	–	22,826
2033	33,235	(2,969)	(7,666)	–	22,599
2034	33,261	(3,036)	(7,943)	–	22,282
2035	33,287	(3,103)	(8,139)	–	22,045
2036	33,313	(3,170)	(8,492)	–	21,651
2037	33,340	(3,237)	(8,688)	–	21,414
2038	33,366	(3,305)	(8,884)	–	21,178
2039	33,393	(3,372)	(9,222)	–	20,799
2040	33,419	(3,439)	(9,391)	–	20,589
2041	33,446	(3,506)	(9,572)	–	20,368
2042	33,472	(3,573)	(9,831)	–	20,068
2043	33,499	(3,640)	(10,090)	–	19,769
2044	33,525	(3,707)	(10,344)	–	19,474
2045	33,552	(3,774)	(10,524)	–	19,254

Table J-10. Moloka'i Customer Level Sales Forecast

## Hawai'i Island Customer Level Sales Forecast

GWh	Underlying Forecast	Energy Efficiency	DG-PV	Electric Vehicles	Customer Level Sales Forecast
Year	a	b	c	d	e = a + b + c + d
2016	1,257	(116)	(129)	0.5	1,012
2017	1,264	(128)	(147)	0.7	989
2018	1,287	(140)	(153)	0.8	994
2019	1,310	(151)	(161)	1.0	999
2020	1,335	(163)	(167)	1.1	1,006
2021	1,351	(174)	(173)	1.2	1,005
2022	1,368	(186)	(177)	1.3	1,007
2023	1,384	(198)	(181)	1.4	1,007
2024	1,403	(212)	(185)	1.6	1,007
2025	1,418	(230)	(189)	1.7	1,001
2026	1,438	(252)	(193)	1.9	995
2027	1,460	(279)	(196)	2.0	986
2028	1,484	(310)	(199)	2.2	977
2029	1,503	(343)	(203)	2.3	959
2030	1,523	(368)	(207)	2.5	951
2031	1,542	(383)	(211)	2.6	950
2032	1,562	(400)	(214)	2.8	951
2033	1,578	(410)	(218)	2.9	953
2034	1,597	(414)	(222)	3.1	964
2035	1,616	(419)	(226)	3.2	975
2036	1,640	(425)	(229)	3.4	989
2037	1,659	(431)	(234)	3.6	998
2038	1,681	(437)	(238)	3.7	1,010
2039	1,704	(444)	(242)	3.9	1,022
2040	1,730	(450)	(247)	4.1	1,037
2041	1,750	(457)	(251)	4.3	1,045
2042	1,773	(464)	(256)	4.4	1,058
2043	1,796	(471)	(261)	4.6	1,069
2044	1,823	(478)	(266)	4.8	1,084
2045	1,844	(485)	(272)	5.0	1,092

Table J-11. Hawai'i Island Customer Level Sales Forecast

## J. Modeling Assumptions Data

### Peak Demand Forecasts

## PEAK DEMAND FORECASTS

### O'ahu Generation Level Peak Demand Forecast

MW	Underlying Forecast	Energy Efficiency	DG-PV	Electric Vehicles	Net Peak Forecast*
Year	a	b	c	d	e = a + b + c + d
2016	1,363.7	(198.7)	0	0	1,165.0
2017	1,397.7	(215.7)	0	0	1,182.0
2018	1,431.7	(232.7)	0	0	1,199.0
2019	1,447.7	(248.7)	0	0	1,199.0
2020	1,454.7	(266.7)	0	0	1,188.0
2021	1,465.7	(284.7)	0	0	1,181.0
2022	1,468.7	(302.7)	0	0	1,166.0
2023	1,473.7	(321.7)	0	0	1,152.0
2024	1,479.7	(344.7)	0	0	1,135.0
2025	1,488.7	(369.7)	0	0	1,119.0
2026	1,499.7	(400.7)	0	0	1,099.0
2027	1,511.7	(436.7)	0	0	1,075.0
2028	1,524.7	(474.7)	0	0	1,050.0
2029	1,534.7	(516.7)	0	0	1,018.0
2030	1,547.7	(560.7)	0	0	987.0
2031	1,555.7	(568.7)	0	0	987.0
2032	1,563.7	(570.7)	0	0	993.0
2033	1,570.7	(571.7)	0	0	999.0
2034	1,578.7	(573.7)	0	0	1,005.0
2035	1,586.7	(576.7)	0	0	1,010.0
2036	1,595.7	(581.7)	0	0	1,014.0
2037	1,605.7	(583.7)	0	0	1,022.0
2038	1,615.7	(587.7)	0	0	1,028.0
2039	1,625.7	(591.7)	0	0	1,034.0
2040	1,634.7	(596.7)	0	0	1,038.0
2041	1,643.7	(599.7)	0	0	1,044.0
2042	1,651.7	(602.7)	0	0	1,049.0
2043	1,660.7	(606.7)	0	0	1,054.0
2044	1,670.7	(611.7)	0	0	1,059.0
2045	1,679.7	(614.7)	0	0	1,065.0

\* System peak occurs in the evening.

Table J-12. O'ahu Generation Level Peak Demand Forecast (MW)

**Maui Island Generation Level Peak Demand Forecast**

<b>MW</b>	<b>Underlying Forecast</b>	<b>Energy Efficiency</b>	<b>DG-PV</b>	<b>Electric Vehicles</b>	<b>Net Peak Forecast*</b>
<b>Year</b>	<i>a</i>	<i>b</i>	<i>c</i>	<i>d</i>	$e = a + b + c + d$
2016	226.7	(25.6)	0	0.2	201.3
2017	234.0	(27.5)	0	0.3	206.8
2018	239.4	(29.3)	0	0.4	210.5
2019	243.4	(31.3)	0	0.6	212.7
2020	245.7	(33.2)	0	0.8	213.3
2021	248.9	(35.0)	0	1.0	214.9
2022	251.5	(37.0)	0	1.3	215.8
2023	254.7	(38.8)	0	0.8	216.7
2024	257.8	(42.1)	0	0.9	216.7
2025	263.0	(45.4)	0	1.1	218.7
2026	268.1	(50.6)	0	1.2	218.7
2027	273.0	(56.2)	0	1.4	218.2
2028	276.7	(62.6)	0	1.6	215.6
2029	281.2	(69.8)	0	1.7	213.2
2030	282.2	(73.9)	0	1.9	210.2
2031	284.5	(78.1)	0	2.1	208.6
2032	286.9	(78.8)	0	2.3	210.4
2033	291.9	(79.9)	0	2.5	214.5
2034	297.1	(81.5)	0	2.6	218.2
2035	302.1	(83.1)	0	2.8	221.9
2036	306.3	(84.6)	0	3.0	224.7
2037	312.1	(86.3)	0	3.2	229.0
2038	316.8	(87.8)	0	3.4	232.5
2039	321.4	(89.2)	0	3.6	235.8
2040	325.2	(90.7)	0	3.8	238.3
2041	330.3	(92.2)	0	4.0	242.2
2042	334.7	(93.5)	0	4.2	245.3
2043	339.0	(95.0)	0	4.4	248.4
2044	342.8	(96.5)	0	4.6	250.9
2045	348.2	(97.9)	0	4.8	255.1

\* System peak occurs in the evening.

Table J-13. Maui Island Generation Level Peak Demand Forecast (MW)

## J. Modeling Assumptions Data

Peak Demand Forecasts

### Lana'i Generation Level Peak Demand Forecast

MW	Underlying Forecast	Energy Efficiency	DG-PV	Electric Vehicles	Net Peak Forecast*
Year	a	b	c	d	$e = a + b + c + d$
2016	5.4	(0.1)	0	0	5.3
2017	5.5	(0.2)	0	0	5.3
2018	5.8	(0.1)	0	0	5.7
2019	5.9	(0.2)	0	0	5.7
2020	5.9	(0.1)	0	0	5.8
2021	5.9	(0.1)	0	0	5.8
2022	6.0	(0.1)	0	0	5.9
2023	6.1	(0.2)	0	0	5.9
2024	6.1	(0.1)	0	0	6.0
2025	6.2	(0.1)	0	0	6.1
2026	6.3	(0.2)	0	0	6.1
2027	6.3	(0.1)	0	0	6.2
2028	6.4	(0.2)	0	0	6.2
2029	6.4	(0.1)	0	0	6.3
2030	6.5	(0.2)	0	0	6.3
2031	6.6	(0.2)	0	0	6.4
2032	6.6	(0.1)	0	0	6.5
2033	6.7	(0.2)	0	0	6.5
2034	6.7	(0.1)	0	0	6.6
2035	6.8	(0.2)	0	0	6.6
2036	6.9	(0.2)	0	0	6.7
2037	6.9	(0.1)	0	0	6.8
2038	7.0	(0.2)	0	0	6.8
2039	7.1	(0.2)	0	0	6.9
2040	7.2	(0.2)	0	0	7.0
2041	7.2	(0.2)	0	0	7.0
2042	7.3	(0.2)	0	0	7.1
2043	7.4	(0.2)	0	0	7.2
2044	7.4	(0.2)	0	0	7.2
2045	7.5	(0.2)	0	0	7.3

\* System peak occurs in the evening.

Table J-14. Lana'i Generation Level Peak Demand Forecast (MW)

**Moloka'i Generation Level Peak Demand Forecast**

<b>MW</b>	<b>Underlying Forecast</b>	<b>Energy Efficiency</b>	<b>DG-PV</b>	<b>Electric Vehicles</b>	<b>Net Peak Forecast*</b>
<i>Year</i>	<i>a</i>	<i>b</i>	<i>c</i>	<i>d</i>	$e = a + b + c + d$
2016	5.8	(0.3)	0	0	5.5
2017	5.9	(0.4)	0	0	5.5
2018	5.9	(0.4)	0	0	5.5
2019	5.9	(0.4)	0	0	5.5
2020	5.9	(0.4)	0	0	5.5
2021	5.9	(0.4)	0	0	5.5
2022	5.9	(0.4)	0	0	5.5
2023	5.9	(0.4)	0	0	5.5
2024	5.9	(0.4)	0	0	5.5
2025	5.9	(0.4)	0	0	5.5
2026	5.9	(0.4)	0	0	5.5
2027	5.9	(0.5)	0	0	5.4
2028	5.9	(0.5)	0	0	5.4
2029	5.9	(0.5)	0	0	5.4
2030	5.9	(0.5)	0	0	5.4
2031	5.9	(0.5)	0	0	5.4
2032	5.9	(0.5)	0	0	5.4
2033	5.9	(0.5)	0	0	5.4
2034	5.9	(0.5)	0	0	5.4
2035	5.9	(0.5)	0	0	5.4
2036	5.9	(0.5)	0	0	5.4
2037	6.0	(0.6)	0	0	5.4
2038	6.0	(0.6)	0	0	5.4
2039	6.0	(0.6)	0	0	5.4
2040	6.0	(0.7)	0	0	5.3
2041	6.0	(0.7)	0	0	5.3
2042	6.0	(0.7)	0	0	5.3
2043	6.0	(0.7)	0	0	5.3
2044	6.0	(0.7)	0	0	5.3
2045	6.0	(0.7)	0	0	5.3

\* System peak occurs in the evening.

Table J-15. Moloka'i Generation Level Peak Demand Forecast (MW)



## J. Modeling Assumptions Data

Peak Demand Forecasts

### Hawai'i Island Generation Level Peak Demand Forecast

MW	Underlying Forecast	Energy Efficiency	DG-PV	Electric Vehicles	Net Peak Forecast*
Year	a	b	c	d	$e = a + b + c + d$
2016	208.2	(21.4)	0	0	186.8
2017	211.6	(23.7)	0	0	187.9
2018	215.4	(26.0)	0	0	189.4
2019	219.5	(28.3)	0	0	191.2
2020	223.2	(30.6)	0	0	192.6
2021	226.7	(32.9)	0	0	193.8
2022	229.6	(35.2)	0	0	194.4
2023	232.4	(37.5)	0	0	194.9
2024	235.0	(41.0)	0	0	194.0
2025	238.3	(44.5)	0	0	193.8
2026	241.8	(49.6)	0	0	192.2
2027	245.6	(55.3)	0	0	190.3
2028	249.2	(61.6)	0	0	187.6
2029	253.1	(68.6)	0	0	184.5
2030	256.6	(71.6)	0	0	185.0
2031	259.9	(74.7)	0	0	185.2
2032	262.8	(78.0)	0	0	184.8
2033	266.3	(78.9)	0	0	187.4
2034	269.6	(79.8)	0	0	189.8
2035	273.1	(80.9)	0	0	192.2
2036	276.5	(82.1)	0	0	194.4
2037	280.7	(83.3)	0	0	197.4
2038	284.6	(84.6)	0	0	200.0
2039	288.6	(85.9)	0	0	202.7
2040	292.3	(87.2)	0	0	205.1
2041	296.7	(88.5)	0	0	208.2
2042	300.8	(89.8)	0	0	211.0
2043	305.0	(91.2)	0	0	213.8
2044	308.9	(92.6)	0	0	216.3
2045	313.4	(94.0)	0	0	219.4

\* System peak occurs in the evening.

Table J-16. Hawai'i Island Generation Level Peak Demand Forecast (MW)

## SALES FORECAST COMPARISONS

### O'ahu December 2016 PSIP Update vs April 2016 PSIP Update Sales Forecast Comparisons

GWh	Underlying Forecast Differential	Energy Efficiency Differential	DG-PV Differential	Electric Vehicles Differential	Customer Level Sales Forecast Differential
Year	a	b	c	d	e = a + b + c + d
2016	0.0	0.0	61.7	0.0	61.7
2017	0.0	0.0	95.6	0.0	95.6
2018	0.0	0.0	69.1	0.0	69.1
2019	0.0	0.0	37.8	0.0	37.8
2020	0.0	0.0	5.9	0.0	5.9
2021	0.0	0.0	(57.3)	0.0	(57.3)
2022	0.0	0.0	(66.8)	0.0	(66.8)
2023	0.0	0.0	(81.9)	0.0	(81.9)
2024	0.0	0.0	(99.1)	0.0	(99.1)
2025	0.0	0.0	(118.2)	0.0	(118.2)
2026	0.0	0.0	(138.4)	0.0	(138.4)
2027	0.0	0.0	(159.2)	0.0	(159.2)
2028	0.0	0.0	(180.8)	0.0	(180.8)
2029	0.0	0.0	(203.8)	0.0	(203.8)
2030	0.0	0.0	(228.6)	0.0	(228.6)
2031	0.0	0.0	(255.3)	0.0	(255.3)
2032	0.0	0.0	(283.8)	0.0	(283.8)
2033	0.0	0.0	(313.9)	0.0	(313.9)
2034	0.0	0.0	(345.3)	0.0	(345.3)
2035	0.0	0.0	(376.7)	0.0	(376.7)
2036	0.0	0.0	(408.4)	0.0	(408.4)
2037	0.0	0.0	(439.3)	0.0	(439.3)
2038	0.0	0.0	(469.1)	0.0	(469.1)
2039	0.0	0.0	(498.3)	0.0	(498.3)
2040	0.0	0.0	(525.6)	0.0	(525.6)
2041	0.0	0.0	(552.7)	0.0	(552.7)
2042	0.0	0.0	(579.5)	0.0	(579.5)
2043	0.0	0.0	(606.6)	0.0	(606.6)
2044	0.0	0.0	(634.2)	0.0	(634.2)
2045	0.0	0.0	(662.5)	0.0	(662.5)

Table J-17. O'ahu December 2016 PSIP Update versus April 2016 PSIP Update Sales Forecast Comparisons (GWh)

**J. Modeling Assumptions Data**

Sales Forecast Comparisons

**Maui Island December 2016 PSIP Update vs April 2016 PSIP Update Sales Forecast Comparisons**

<b>GWh</b>	<b>Underlying Forecast Differential</b>	<b>Energy Efficiency Differential</b>	<b>DG-PV Differential</b>	<b>Electric Vehicles Differential</b>	<b>Customer Level Sales Forecast Differential</b>
<i>Year</i>	<i>a</i>	<i>b</i>	<i>c</i>	<i>d</i>	<i>e = a + b + c + d</i>
2016	–	–	14.0	–	14.0
2017	–	–	5.6	–	5.6
2018	–	–	2.3	–	2.3
2019	–	–	(3.3)	–	(3.3)
2020	–	–	(9.8)	–	(9.8)
2021	–	–	(13.6)	–	(13.6)
2022	–	–	(16.0)	–	(16.0)
2023	–	–	(17.3)	–	(17.3)
2024	–	–	(19.0)	–	(19.0)
2025	–	–	(20.5)	–	(20.5)
2026	–	–	(22.3)	–	(22.3)
2027	–	–	(23.8)	–	(23.8)
2028	–	–	(25.8)	–	(25.8)
2029	–	–	(27.5)	–	(27.5)
2030	–	–	(29.6)	–	(29.6)
2031	–	–	(31.4)	–	(31.4)
2032	–	–	(33.5)	–	(33.5)
2033	–	–	(35.1)	–	(35.1)
2034	–	–	(37.2)	–	(37.2)
2035	–	–	(38.9)	–	(38.9)
2036	–	–	(41.1)	–	(41.1)
2037	–	–	(43.0)	–	(43.0)
2038	–	–	(45.5)	–	(45.5)
2039	–	–	(47.7)	–	(47.7)
2040	–	–	(50.5)	–	(50.5)
2041	–	–	(53.0)	–	(53.0)
2042	–	–	(55.9)	–	(55.9)
2043	–	–	(58.8)	–	(58.8)
2044	–	–	(62.5)	–	(62.5)
2045	–	–	(65.9)	–	(65.9)

Table J-18. Maui Island December 2016 PSIP Update versus April 2016 PSIP Update Sales Forecast Comparisons (GWh)



**Lana'i December 2016 PSIP Update vs April 2016 PSIP Update Sales Forecast Comparisons**

<b>MWh</b>	<b>Underlying Forecast Differential</b>	<b>Energy Efficiency Differential</b>	<b>DG-PV Differential</b>	<b>Electric Vehicles Differential</b>	<b>Customer Level Sales Forecast Differential</b>
<i>Year</i>	<i>a</i>	<i>b</i>	<i>c</i>	<i>d</i>	<i>e = a + b + c + d</i>
2016	-	-	(0.3)	-	(0.3)
2017	-	-	(0.9)	-	(0.9)
2018	-	-	(1.0)	-	(1.0)
2019	-	-	(1.0)	-	(1.0)
2020	-	-	(1.0)	-	(1.0)
2021	-	-	(0.9)	-	(0.9)
2022	-	-	(0.9)	-	(0.9)
2023	-	-	(0.8)	-	(0.8)
2024	-	-	(0.7)	-	(0.7)
2025	-	-	(0.6)	-	(0.6)
2026	-	-	(0.6)	-	(0.6)
2027	-	-	(0.5)	-	(0.5)
2028	-	-	(0.5)	-	(0.5)
2029	-	-	(0.6)	-	(0.6)
2030	-	-	(0.6)	-	(0.6)
2031	-	-	(0.6)	-	(0.6)
2032	-	-	(0.7)	-	(0.7)
2033	-	-	(0.8)	-	(0.8)
2034	-	-	(0.8)	-	(0.8)
2035	-	-	(0.9)	-	(0.9)
2036	-	-	(0.9)	-	(0.9)
2037	-	-	(1.0)	-	(1.0)
2038	-	-	(1.2)	-	(1.2)
2039	-	-	(1.3)	-	(1.3)
2040	-	-	(1.3)	-	(1.3)
2041	-	-	(1.4)	-	(1.4)
2042	-	-	(1.5)	-	(1.5)
2043	-	-	(1.5)	-	(1.5)
2044	-	-	(1.7)	-	(1.7)
2045	-	-	(1.8)	-	(1.8)

Table J-19. Lana'i December 2016 PSIP Update versus April 2016 PSIP Update Sales Forecast Comparisons (MWh)

**J. Modeling Assumptions Data**

Sales Forecast Comparisons

**Moloka'i December 2016 PSIP Update vs April 2016 PSIP Update Sales Forecast Comparisons**

MWh	Underlying Forecast Differential	Energy Efficiency Differential	DG-PV Differential	Electric Vehicles Differential	Customer Level Sales Forecast Differential
Year	a	b	c	d	e = a + b + c + d
2016	-	-	(0.0)	-	(0.0)
2017	-	-	(0.4)	-	(0.4)
2018	-	-	(1.6)	-	(1.6)
2019	-	-	(1.8)	-	(1.8)
2020	-	-	(1.8)	-	(1.8)
2021	-	-	(2.0)	-	(2.0)
2022	-	-	(2.0)	-	(2.0)
2023	-	-	(1.9)	-	(1.9)
2024	-	-	(1.8)	-	(1.8)
2025	-	-	(1.8)	-	(1.8)
2026	-	-	(1.7)	-	(1.7)
2027	-	-	(1.7)	-	(1.7)
2028	-	-	(1.8)	-	(1.8)
2029	-	-	(1.9)	-	(1.9)
2030	-	-	(2.0)	-	(2.0)
2031	-	-	(2.1)	-	(2.1)
2032	-	-	(2.2)	-	(2.2)
2033	-	-	(2.3)	-	(2.3)
2034	-	-	(2.6)	-	(2.6)
2035	-	-	(2.7)	-	(2.7)
2036	-	-	(3.0)	-	(3.0)
2037	-	-	(3.2)	-	(3.2)
2038	-	-	(3.4)	-	(3.4)
2039	-	-	(3.7)	-	(3.7)
2040	-	-	(3.9)	-	(3.9)
2041	-	-	(4.1)	-	(4.1)
2042	-	-	(4.3)	-	(4.3)
2043	-	-	(4.6)	-	(4.6)
2044	-	-	(4.8)	-	(4.8)
2045	-	-	(5.0)	-	(5.0)

Table J-20. Moloka'i December 2016 PSIP Update versus April 2016 PSIP Update Sales Forecast Comparisons (MWh)

Hawai'i Island December 2016 PSIP Update vs April 2016 PSIP Update Sales Forecast Comparison

GWh	Underlying Forecast Differential	Energy Efficiency Differential	DG-PV Differential	Electric Vehicles Differential	Customer Level Sales Forecast Differential
Year	a	b	c	d	e = a + b + c + d
2016	-	-	0.4	-	0.4
2017	-	-	2.6	-	2.6
2018	-	-	1.0	-	1.0
2019	-	-	(0.5)	-	(0.5)
2020	-	-	(2.8)	-	(2.8)
2021	-	-	(4.8)	-	(4.8)
2022	-	-	(5.9)	-	(5.9)
2023	-	-	(7.9)	-	(7.9)
2024	-	-	(10.1)	-	(10.1)
2025	-	-	(12.3)	-	(12.3)
2026	-	-	(14.4)	-	(14.4)
2027	-	-	(16.1)	-	(16.1)
2028	-	-	(17.1)	-	(17.1)
2029	-	-	(18.8)	-	(18.8)
2030	-	-	(20.1)	-	(20.1)
2031	-	-	(22.0)	-	(22.0)
2032	-	-	(23.3)	-	(23.3)
2033	-	-	(25.2)	-	(25.2)
2034	-	-	(26.5)	-	(26.5)
2035	-	-	(28.3)	-	(28.3)
2036	-	-	(29.8)	-	(29.8)
2037	-	-	(31.7)	-	(31.7)
2038	-	-	(33.5)	-	(33.5)
2039	-	-	(35.6)	-	(35.6)
2040	-	-	(37.5)	-	(37.5)
2041	-	-	(39.9)	-	(39.9)
2042	-	-	(41.9)	-	(41.9)
2043	-	-	(44.6)	-	(44.6)
2044	-	-	(46.9)	-	(46.9)
2045	-	-	(49.9)	-	(49.9)

Table J-21. Hawai'i Island December 2016 PSIP Update versus April 2016 PSIP Update Sales Forecast Comparisons (GWh)

## J. Modeling Assumptions Data

Sales Forecast Comparisons

### O'ahu DG-PV Forecast Cumulative Installed Capacity

	February 2016 Interim Filing	April 2016 PSIP Update	December 2016 PSIP Update	High DG-PV
<i>Year</i>	<i>MW</i>	<i>MW</i>	<i>MW</i>	<i>MW</i>
2016	447	445	407	407
2017	548	538	479	479
2018	572	563	520	520
2019	591	589	566	566
2020	608	610	606	606
2021	620	626	662	662
2022	631	639	680	690
2023	642	650	701	743
2024	652	661	722	805
2025	663	672	745	867
2026	674	683	769	928
2027	685	694	793	990
2028	696	705	817	1,052
2029	708	716	842	1,114
2030	720	727	869	1,175
2031	733	738	896	1,237
2032	747	749	925	1,299
2033	761	760	955	1,361
2034	776	771	985	1,422
2035	791	782	1,015	1,484
2036	808	793	1,046	1,546
2037	824	804	1,076	1,607
2038	841	815	1,106	1,669
2039	859	826	1,135	1,731
2040	877	837	1,163	1,793
2041	895	849	1,192	1,854
2042	914	860	1,220	1,916
2043	933	872	1,249	1,978
2044	952	884	1,278	2,040
2045	971	897	1,308	2,101

Table J-22. O'ahu DG-PV Forecast Cumulative Installed Capacity

**Maui DG-PV Forecast Cumulative Installed Capacity**

	<b>February 2016 Interim Filing</b>	<b>April 2016 PSIP Update</b>	<b>December 2016 PSIP Update</b>	<b>High DG-PV</b>
<i>Year</i>	<i>MW</i>	<i>MW</i>	<i>MW</i>	<i>MW</i>
2016	99	98	90	98
2017	117	115	113	115
2018	120	118	118	118
2019	123	122	125	125
2020	125	124	132	132
2021	126	126	136	136
2022	127	127	139	140
2023	127	128	141	153
2024	128	129	143	166
2025	129	130	144	178
2026	129	130	146	191
2027	130	131	148	204
2028	131	132	151	217
2029	132	133	153	230
2030	133	134	155	243
2031	134	135	157	255
2032	135	136	159	268
2033	136	137	162	281
2034	138	138	164	294
2035	139	139	166	307
2036	141	140	169	319
2037	143	142	171	332
2038	144	143	174	345
2039	146	144	177	358
2040	148	145	180	371
2041	150	147	183	384
2042	153	148	186	396
2043	155	150	189	409
2044	157	151	193	422
2045	160	153	197	435

Table J-23. Maui DG-PV Forecast Cumulative Installed Capacity



## J. Modeling Assumptions Data

Sales Forecast Comparisons

### Lana'i DG-PV Forecast Cumulative Installed Capacity

	February 2016 Interim Filing	April 2016 PSIP Update	December 2016 PSIP Update	High DG-PV
<i>Year</i>	<i>MW</i>	<i>MW</i>	<i>MW</i>	<i>MW</i>
2016	0.7	0.6	0.8	0.8
2017	0.7	0.6	1.3	1.3
2018	0.8	0.6	1.4	1.4
2019	0.8	0.7	1.4	1.4
2020	0.9	0.7	1.5	1.5
2021	0.9	0.8	1.5	1.5
2022	1.0	0.9	1.5	1.7
2023	1.1	0.9	1.6	2.0
2024	1.1	1.0	1.6	2.3
2025	1.2	1.0	1.6	2.5
2026	1.2	1.1	1.6	2.8
2027	1.3	1.1	1.6	3.1
2028	1.3	1.2	1.6	3.3
2029	1.4	1.2	1.7	3.6
2030	1.4	1.2	1.7	3.8
2031	1.4	1.2	1.8	4.1
2032	1.4	1.2	1.9	4.4
2033	1.4	1.2	1.9	4.6
2034	1.4	1.2	1.9	4.9
2035	1.4	1.2	2.0	5.2
2036	1.4	1.2	2.0	5.4
2037	1.4	1.2	2.1	5.7
2038	1.4	1.2	2.2	6.0
2039	1.4	1.2	2.3	6.2
2040	1.4	1.2	2.3	6.5
2041	1.4	1.2	2.4	6.7
2042	1.4	1.2	2.4	7.0
2043	1.4	1.2	2.4	7.3
2044	1.4	1.2	2.6	7.5
2045	1.4	1.2	2.6	7.8

Table J-24. Lana'i DG-PV Forecast Cumulative Installed Capacity

**Moloka'i DG-PV Forecast Cumulative Installed Capacity**

	<b>February 2016 Interim Filing</b>	<b>April 2016 PSIP Update</b>	<b>December 2016 PSIP Update</b>	<b>High DG-PV</b>
<i>Year</i>	<i>MW</i>	<i>MW</i>	<i>MW</i>	<i>MW</i>
2016	2.6	2.2	2.0	2.1
2017	2.6	2.3	2.3	2.5
2018	2.7	2.3	3.0	3.1
2019	2.7	2.4	3.2	3.2
2020	2.9	2.5	3.4	3.4
2021	2.9	2.6	3.5	3.5
2022	3.0	2.6	3.5	3.6
2023	3.1	2.7	3.5	3.6
2024	3.1	2.7	3.5	3.8
2025	3.2	2.8	3.6	4.0
2026	3.3	2.9	3.6	4.1
2027	3.4	2.9	3.7	4.3
2028	3.5	3.0	3.8	4.4
2029	3.5	3.1	3.9	4.6
2030	3.6	3.2	4.0	4.7
2031	3.7	3.2	4.2	4.9
2032	3.8	3.3	4.3	5.0
2033	3.9	3.4	4.4	5.2
2034	3.9	3.4	4.6	5.4
2035	4.0	3.4	4.7	5.5
2036	4.0	3.5	4.9	5.7
2037	4.0	3.5	5.0	5.8
2038	4.0	3.5	5.1	6.0
2039	4.0	3.5	5.3	6.1
2040	4.0	3.5	5.4	6.3
2041	4.0	3.5	5.5	6.4
2042	4.0	3.5	5.7	6.6
2043	4.0	3.5	5.8	6.8
2044	4.0	3.5	6.0	6.9
2045	4.0	3.5	6.1	7.1

Table J-25. Moloka'i DG-PV Forecast Cumulative Installed Capacity

## J. Modeling Assumptions Data

Sales Forecast Comparisons

### Hawai'i Island DG-PV Forecast Cumulative Installed Capacity

	February 2016 Interim Filing	April 2016 PSIP Update	December 2016 PSIP Update	High DG-PV
<i>Year</i>	<i>MW</i>	<i>MW</i>	<i>MW</i>	<i>MW</i>
2016	88	87	87	88
2017	102	101	99	103
2018	106	104	104	107
2019	109	108	108	111
2020	112	111	113	115
2021	115	114	117	119
2022	117	115	119	131
2023	118	117	122	145
2024	120	118	125	160
2025	122	119	127	174
2026	124	120	130	188
2027	125	122	133	202
2028	127	123	135	216
2029	129	125	137	230
2030	131	126	140	244
2031	133	127	142	258
2032	135	129	145	273
2033	137	130	147	287
2034	140	132	150	301
2035	142	133	152	315
2036	144	135	155	329
2037	147	136	158	343
2038	149	138	161	357
2039	152	140	164	372
2040	156	141	167	386
2041	159	143	170	400
2042	163	145	173	414
2043	168	146	176	428
2044	172	148	180	442
2045	178	150	184	456

Table J-26. Hawai'i Island DG-PV Forecast Cumulative Installed Capacity

O'ahu Self-Supply DESS Forecast Cumulative Installed Capacity

	December 2016 PSIP Update	High DG-PV
<i>Year</i>	<i>MWh</i>	<i>MWh</i>
2016	–	–
2017	3	3
2018	16	16
2019	35	35
2020	56	56
2021	70	70
2022	79	79
2023	89	89
2024	98	98
2025	108	111
2026	118	135
2027	128	160
2028	138	185
2029	148	211
2030	157	238
2031	168	266
2032	178	294
2033	190	324
2034	202	354
2035	213	384
2036	225	416
2037	235	448
2038	246	481
2039	255	515
2040	264	549
2041	273	585
2042	282	621
2043	290	657
2044	298	695
2045	306	733

Table J-27. O'ahu Self-Supply DESS Forecast Cumulative Installed Capacity

## J. Modeling Assumptions Data

Sales Forecast Comparisons

### Maui Self-Supply DESS Forecast Cumulative Installed Capacity

	December 2016 PSIP Update	High DG-PV
<i>Year</i>	<i>MWh</i>	<i>MWh</i>
2016	–	–
2017	1	1
2018	3	3
2019	6	6
2020	9	9
2021	11	11
2022	12	12
2023	13	15
2024	14	20
2025	15	25
2026	16	31
2027	17	37
2028	18	43
2029	20	49
2030	21	55
2031	22	62
2032	23	68
2033	24	75
2034	26	82
2035	27	90
2036	28	97
2037	30	105
2038	31	112
2039	33	120
2040	34	128
2041	36	137
2042	38	145
2043	40	154
2044	42	163
2045	45	172

Table J-28. Maui Self-Supply DESS Forecast Cumulative Installed Capacity

**Lana'i Self-Supply DESS Forecast Cumulative Installed Capacity**

	<b>December 2016 PSIP Update</b>	<b>High DG-PV</b>
<i>Year</i>	<i>MWh</i>	<i>MWh</i>
2016	–	–
2017	0.0	0.0
2018	0.0	0.0
2019	0.0	0.0
2020	0.0	0.0
2021	0.1	0.1
2022	0.1	0.2
2023	0.1	0.3
2024	0.1	0.4
2025	0.1	0.6
2026	0.1	0.8
2027	0.1	0.9
2028	0.1	1.1
2029	0.2	1.3
2030	0.2	1.5
2031	0.2	1.7
2032	0.3	1.9
2033	0.3	2.1
2034	0.3	2.3
2035	0.4	2.5
2036	0.4	2.7
2037	0.5	2.9
2038	0.5	3.2
2039	0.5	3.5
2040	0.6	3.7
2041	0.6	4.0
2042	0.6	4.2
2043	0.7	4.5
2044	0.7	4.7
2045	0.8	5.0

Table J-29. Lana'i Self-Supply DESS Forecast Cumulative Installed Capacity

## J. Modeling Assumptions Data

Sales Forecast Comparisons

### Moloka'i Self-Supply DESS Forecast Cumulative Installed Capacity

	December 2016 PSIP Update	High DG-PV
<i>Year</i>	<i>MWh</i>	<i>MWh</i>
2016	–	–
2017	0.0	0.0
2018	0.1	0.1
2019	0.2	0.2
2020	0.3	0.3
2021	0.3	0.3
2022	0.4	0.4
2023	0.4	0.4
2024	0.4	0.5
2025	0.4	0.6
2026	0.5	0.7
2027	0.5	0.9
2028	0.6	1.0
2029	0.7	1.2
2030	0.8	1.3
2031	1.0	1.4
2032	1.1	1.6
2033	1.2	1.7
2034	1.3	1.9
2035	1.5	2.0
2036	1.6	2.2
2037	1.7	2.3
2038	1.8	2.5
2039	2.0	2.7
2040	2.1	2.9
2041	2.2	3.0
2042	2.3	3.2
2043	2.4	3.4
2044	2.5	3.6
2045	2.6	3.7

Table J-30. Moloka'i Self-Supply DESS Forecast Cumulative Installed Capacity

**Hawai'i Island Self-Supply DESS Forecast Cumulative Installed Capacity**

	<b>December 2016 PSIP Update</b>	<b>High DG-PV</b>
<i>Year</i>	<i>MWh</i>	<i>MWh</i>
2016	–	–
2017	0	1
2018	2	2
2019	4	4
2020	6	6
2021	8	8
2022	9	12
2023	10	19
2024	12	26
2025	13	33
2026	14	41
2027	15	49
2028	17	57
2029	18	65
2030	19	74
2031	20	83
2032	22	92
2033	23	101
2034	25	111
2035	26	121
2036	27	131
2037	29	141
2038	30	152
2039	32	163
2040	33	174
2041	35	185
2042	36	196
2043	38	208
2044	40	220
2045	43	232

Table J-31. Hawai'i Island Self-Supply DESS Forecast Cumulative Installed Capacity



## J. Modeling Assumptions Data

UHERO State of Hawai'i Forecasts

### UHERO STATE OF HAWAI'I FORECASTS

#### State of Hawai'i 2014 and 2015 Non-Agricultural Job Forecasts

Year	2015 Outlook	2014 Outlook	% Difference (15/14)
2013	618,600	617,600	0.2%
2014	625,300	626,200	-0.1%
2015	634,500	636,900	-0.4%
2016	642,800	647,100	-0.7%
2017	649,500	655,700	-0.9%
2018	654,100	661,400	-1.1%
2019	657,200	664,100	-1.0%
2020	658,900	665,600	-1.0%
2021	660,100	668,400	-1.2%
2022	661,100	672,500	-1.7%
2023	663,000	677,100	-2.1%
2024	666,200	682,200	-2.3%
2025	671,500	687,300	-2.3%
2026	678,200	692,000	-2.0%
2027	685,000	696,400	-1.6%
2028	691,000	700,800	-1.4%
2029	695,600	705,200	-1.4%
2030	698,600	709,700	-1.6%

Table J-32. State of Hawai'i 2014 and 2015 Non-Agricultural Job Forecasts

**State of Hawai'i 2014 and 2015 Real Personal Income per Capita Forecasts**

<b>Year</b>	<b>2015 Outlook</b>	<b>2014 Outlook</b>	<b>% Difference (15/14)</b>
2013	17.8	18.0	-1.0%
2014	18.1	18.2	-0.9%
2015	18.4	18.7	-1.7%
2016	18.7	19.0	-1.7%
2017	18.9	19.2	-1.6%
2018	19.1	19.3	-1.3%
2019	19.2	19.3	-0.9%
2020	19.3	19.4	-0.6%
2021	19.3	19.4	-0.5%
2022	19.4	19.5	-0.6%
2023	19.5	19.6	-0.6%
2024	19.6	19.7	-0.5%
2025	19.8	19.8	-0.1%
2026	20.0	19.9	0.3%
2027	20.2	20.0	0.8%
2028	20.3	20.1	1.0%
2029	20.4	20.2	1.1%
2030	20.5	20.3	1.0%

Table J-33. State of Hawai'i 2014 and 2015 Real Personal Income per Capita Forecasts (thousands)

## J. Modeling Assumptions Data

UHERO State of Hawai'i Forecasts

### State of Hawai'i 2014 and 2015 Visitor Arrivals Forecasts

Year	2015 Outlook	2014 Outlook	% Difference (15/14)
2013	8,003.5	8,064.3	-0.8%
2014	8,159.6	8,141.6	0.2%
2015	8,233.5	8,268.7	-0.4%
2016	8,302.4	8,366.9	-0.8%
2017	8,345.6	8,447.7	-1.2%
2018	8,404.6	8,521.5	-1.4%
2019	8,439.8	8,591.6	-1.8%
2020	8,477.4	8,657.7	-2.1%
2021	8,524.9	8,720.6	-2.2%
2022	8,578.1	8,778.8	-2.3%
2023	8,636.4	8,832.1	-2.2%
2024	8,696.6	8,880.3	-2.1%
2025	8,758.0	8,923.4	-1.9%
2026	8,817.5	8,962.3	-1.6%
2027	8,866.8	8,998.3	-1.5%
2028	8,906.7	9,033.6	-1.4%
2029	8,936.5	9,069.1	-1.5%
2030	8,960.9	9,108.3	-1.6%

Table J-34. State of Hawai'i 2014 and 2015 Visitor Arrivals Forecasts (thousands)

## RESOURCE CAPITAL COSTS

Resource costs and potential are key foundational assumptions for developing the PSIP. We have re-evaluated our resource costs since filing our April 2016 PSIP update.

### New Resource Cost Assumptions: O’ahu

Hawai’i specific nominal overnight capital cost \$/kW<sub>AC</sub>, without an Allowance for Funds Used During Construction (AFUDC)<sup>7</sup>

Nominal \$/kW	Replacement Resource Capital Cost Assumptions (without AFUDC): O’ahu						
	Onshore Wind*	Offshore Wind Floating Platform*	Onshore Wind + Cable*	Onshore Wind + Cable*	Utility-Scale Solar PV*	Solar DG-PV	CSP w/ 10 Hours Storage
Technology							
Size (MW)	30	400	200	400	20	< 10 kW	100
Fuel	n/a	n/a	n/a	n/a	n/a	n/a	n/a
Source	IHS Energy RSMMeans	NREL	IHS Energy RSMMeans Vendor Quotes	IHS Energy RSMMeans Vendor Quotes	IHS Energy RSMMeans	IHS Energy RSMMeans	NREL
Island	O’ahu	O’ahu	Maui to O’ahu	Maui to O’ahu	O’ahu	O’ahu	O’ahu
2016	\$2,215	\$6,340	n/a	n/a	\$2,293	\$3,945	\$12,304
2017	\$2,254	\$6,255	n/a	n/a	\$2,127	\$3,716	\$12,525
2018	\$2,193	\$6,165	n/a	n/a	\$2,047	\$3,573	\$11,681
2019	\$2,178	\$6,070	n/a	n/a	\$1,984	\$3,457	\$10,781
2020	\$2,230	\$5,969	\$4,847	\$4,322	\$1,932	\$3,360	\$9,848
2021	\$2,520	\$5,880	\$5,207	\$4,672	\$1,892	\$3,285	\$8,874
2022	\$2,586	\$5,720	\$5,324	\$4,778	\$2,099	\$3,218	\$7,867
2023	\$2,644	\$5,553	\$5,456	\$4,899	\$2,064	\$3,160	\$7,813
2024	\$2,691	\$5,571	\$5,560	\$4,992	\$2,035	\$3,111	\$7,756
2025	\$2,722	\$5,587	\$5,664	\$5,085	\$2,012	\$3,068	\$7,694
2026	\$2,753	\$5,602	\$5,758	\$5,166	\$1,995	\$3,034	\$7,627
2027	\$2,773	\$5,616	\$5,851	\$5,248	\$1,980	\$3,004	\$7,555
2028	\$2,805	\$5,629	\$5,948	\$5,333	\$1,966	\$2,976	\$7,478
2029	\$2,830	\$5,640	\$6,049	\$5,422	\$1,955	\$2,952	\$7,396
2030	\$2,867	\$5,650	\$6,154	\$5,514	\$1,946	\$2,933	\$7,309

\* = Amounts have been reduced by the \$500,000 state tax credit cap

Table J-35. Replacement Resource Capital Cost Assumptions: O’ahu 2016–2030 (1a of 2)

<sup>7</sup> Solar PV costs are typically quoted based on the price per kW of Direct Current (DC) output (that is, the total capacity of the PV panels). These utility-scale solar PV costs has been converted to the price per kW of Alternating Current (AC) output supplied to the grid using a DC to AC 1.5:1 ratio.

## J. Modeling Assumptions Data

Resource Capital Costs

### New Resource Cost Assumptions: O'ahu (1b of 2)

Hawai'i specific nominal overnight capital cost \$/kW<sub>AC</sub>, without AFUDC

Nominal \$/kW	Replacement Resource Capital Cost Assumptions (without AFUDC): O'ahu						
	Technology	Onshore Wind*	Offshore Wind Floating Platform*	Onshore Wind + Cable*	Onshore Wind + Cable*	Utility-Scale Solar PV*	Solar DG-PV
Size (MW)	30	400	200	400	20	< 10 kW	100
Fuel	n/a	n/a	n/a	n/a	n/a	n/a	n/a
Source	IHS Energy RSMMeans	NREL	IHS Energy RSMMeans Vendor Quotes	IHS Energy RSMMeans Vendor Quotes	IHS Energy RSMMeans	IHS Energy RSMMeans	NREL
Island	O'ahu	O'ahu	Maui to O'ahu	Maui to O'ahu	O'ahu	O'ahu	O'ahu
2031	\$2,891	\$5,705	\$6,257	\$5,604	\$1,937	\$2,925	\$7,216
2032	\$2,925	\$5,760	\$6,362	\$5,696	\$1,928	\$2,917	\$7,117
2033	\$2,949	\$5,815	\$6,468	\$5,789	\$1,920	\$2,910	\$7,245
2034	\$2,984	\$5,871	\$6,577	\$5,884	\$1,910	\$2,902	\$7,375
2035	\$3,010	\$5,926	\$6,688	\$5,981	\$1,902	\$2,894	\$7,508
2036	\$3,045	\$5,982	\$6,800	\$6,079	\$1,893	\$2,887	\$7,643
2037	\$3,071	\$6,037	\$6,915	\$6,179	\$1,884	\$2,879	\$7,781
2038	\$3,107	\$6,093	\$7,031	\$6,281	\$1,875	\$2,872	\$7,921
2039	\$3,134	\$6,149	\$7,150	\$6,385	\$1,867	\$2,864	\$8,064
2040	\$3,171	\$6,205	\$7,270	\$6,490	\$1,857	\$2,856	\$8,209
2041	\$3,199	\$6,266	\$7,393	\$6,598	\$1,849	\$2,849	\$8,356
2042	\$3,237	\$6,328	\$7,518	\$6,707	\$1,839	\$2,841	\$8,507
2043	\$3,265	\$6,390	\$7,646	\$6,818	\$1,831	\$2,834	\$8,660
2044	\$3,303	\$6,452	\$7,775	\$6,931	\$1,821	\$2,827	\$8,816
2045	\$3,333	\$6,514	\$7,907	\$7,046	\$1,813	\$2,819	\$8,975

\* = Amounts have been reduced by the \$500,000 state tax credit cap

Table J-36. Replacement Resource Capital Cost Assumptions: O'ahu 2031–2045 (1b of 2)

New Resource Cost Assumptions: O’ahu (2a of 2)

Hawai’i specific nominal overnight capital cost \$/kW<sub>AC</sub>, without AFUDC

Nominal \$/kW	Replacement Resource Capital Cost Assumptions (without AFUDC): O’ahu						
	Technology	Combined Cycle Gas	Combined Cycle Gas	Simple Cycle Gas	Biomass	Internal Combustion	Internal Combustion
Size (MW)	383 (3 x 1)	152 (1 x 1)	100	20	27 (3 x 9 MW)	54 (6 x 9 MW)	100 (6 x 16.8 MW) Power Barge
Fuel	Gas / Oil	Gas / Oil	Gas / Oil	Biomass	Gas / Oil	Gas / Oil	Gas / Oil
Source	NextEra	NextEra	Gas Turbine World RSMean	NREL	Hawaiian Electric	Hawaiian Electric Schofield Application	Hawaiian Electric
Island	O’ahu	O’ahu	O’ahu	O’ahu, Maui, Hawai’i Island	O’ahu, Maui, Hawai’i Island	O’ahu, Maui, Hawai’i Island	O’ahu
2016	\$1,758	\$1,660	\$1,237	\$6,296	\$3,177	\$2,493	\$1,323
2017	\$1,783	\$1,683	\$1,253	\$6,092	\$3,219	\$2,526	\$1,347
2018	\$1,797	\$1,697	\$1,261	\$6,178	\$3,238	\$2,541	\$1,371
2019	\$1,822	\$1,720	\$1,277	\$6,269	\$3,280	\$2,574	\$1,396
2020	\$1,845	\$1,742	\$1,292	\$6,354	\$3,319	\$2,604	\$1,421
2021	\$1,870	\$1,766	\$1,309	\$6,446	\$3,362	\$2,638	\$1,447
2022	\$1,896	\$1,790	\$1,326	\$6,541	\$3,406	\$2,672	\$1,473
2023	\$1,921	\$1,813	\$1,342	\$6,633	\$3,448	\$2,705	\$1,499
2024	\$1,944	\$1,836	\$1,358	\$6,725	\$3,487	\$2,736	\$1,526
2025	\$1,969	\$1,859	\$1,373	\$6,826	\$3,527	\$2,768	\$1,554
2026	\$1,992	\$1,881	\$1,388	\$6,918	\$3,564	\$2,797	\$1,582
2027	\$2,021	\$1,909	\$1,408	\$7,019	\$3,617	\$2,838	\$1,610
2028	\$2,051	\$1,937	\$1,428	\$7,121	\$3,668	\$2,878	\$1,639
2029	\$2,079	\$1,963	\$1,447	\$7,222	\$3,716	\$2,916	\$1,669
2030	\$2,108	\$1,991	\$1,466	\$7,323	\$3,766	\$2,955	\$1,699

Table J-37. Replacement Resource Capital Cost Assumptions: O’ahu 2016–2030 (2a of 2)

## J. Modeling Assumptions Data

Resource Capital Costs

### New Resource Cost Assumptions: O'ahu (2b of 2)

Hawai'i specific nominal overnight capital cost \$/kW<sub>AC</sub>, without AFUDC

Nominal \$/kW	Replacement Resource Capital Cost Assumptions (without AFUDC): O'ahu						
	Technology	Combined Cycle Gas	Combined Cycle Gas	Simple Cycle Gas	Biomass	Internal Combustion	Internal Combustion
Size (MW)	383 (3 x 1)	152 (1 x 1)	100	20	27 (3 x 9 MW)	54 (6 x 9 MW)	100 (6 x 16.8 MW) Power Barge
Fuel	Gas / Oil	Gas / Oil	Gas / Oil	Biomass	Gas / Oil	Gas / Oil	Gas / Oil
Source	NextEra	NextEra	Gas Turbine World RSMean	NREL	Hawaiian Electric	Hawaiian Electric Schofield Application	Hawaiian Electric
Island	O'ahu	O'ahu	O'ahu	O'ahu, Maui, Hawai'i Island	O'ahu, Maui, Hawai'i Island	O'ahu, Maui, Hawai'i Island	O'ahu
2031	\$2,139	\$2,019	\$1,487	\$7,425	\$3,819	\$2,997	\$1,729
2032	\$2,169	\$2,048	\$1,507	\$7,528	\$3,872	\$3,038	\$1,761
2033	\$2,202	\$2,079	\$1,530	\$7,638	\$3,930	\$3,083	\$1,792
2034	\$2,234	\$2,110	\$1,552	\$7,743	\$3,986	\$3,127	\$1,825
2035	\$2,270	\$2,143	\$1,577	\$7,850	\$4,050	\$3,178	\$1,857
2036	\$2,304	\$2,176	\$1,601	\$7,952	\$4,112	\$3,226	\$1,891
2037	\$2,342	\$2,211	\$1,627	\$8,062	\$4,179	\$3,279	\$1,925
2038	\$2,379	\$2,246	\$1,653	\$8,166	\$4,246	\$3,331	\$1,959
2039	\$2,419	\$2,284	\$1,681	\$8,267	\$4,317	\$3,387	\$1,995
2040	\$2,455	\$2,318	\$1,706	\$8,361	\$4,382	\$3,439	\$2,031
2041	\$2,499	\$2,360	\$1,737	\$8,512	\$4,461	\$3,501	\$2,067
2042	\$2,544	\$2,403	\$1,768	\$8,665	\$4,542	\$3,564	\$2,104
2043	\$2,590	\$2,446	\$1,800	\$8,821	\$4,623	\$3,628	\$2,142
2044	\$2,637	\$2,490	\$1,832	\$8,979	\$4,707	\$3,693	\$2,181
2045	\$2,684	\$2,535	\$1,865	\$9,141	\$4,791	\$3,760	\$2,220

Table J-38. Replacement Resource Capital Cost Assumptions: O'ahu 2031–2045 (2b of 2)

## New Resource Cost Assumptions: Maui, Lana'i, Moloka'i, Hawai'i Island

Hawai'i specific nominal overnight capital cost \$/kW<sub>AC</sub> (without AFUDC)

Nominal \$/kW	Replacement Resource Capital Cost Assumptions (without AFUDC): Maui, Lana'i, Moloka'i, Hawai'i Island							
	Onshore Wind*	Onshore Wind*	Onshore Wind*	Onshore Wind*	Utility-Scale Solar PV*	Utility-Scale Solar PV*	Utility-Scale Solar PV*	Utility-Scale Solar PV*
Technology								
Size (MW)	10	20	30	1 (10 x 100 kW)	1	5	10	20
Fuel	n/a	n/a	n/a	n/a	n/a	n/a	n/a	n/a
Source	IHS, RSMMeans	IHS, RSMMeans	IHS, RSMMeans	Indicative quote from NPS + install estimate	IHS, RSMMeans	IHS, RSMMeans	IHS, RSMMeans	IHS, RSMMeans
Island	Hawai'i Maui	Hawai'i Maui	Hawai'i Maui	Lana'i Moloka'i	Lana'i Moloka'i	Hawai'i Maui	Hawai'i Maui	Hawai'i Maui
2016	\$3,921	\$2,718	\$2,215	\$3,510	\$3,523	\$2,762	\$2,349	\$2,074
2017	\$3,987	\$2,765	\$2,254	\$3,603	\$3,283	\$2,568	\$2,180	\$1,921
2018	\$3,884	\$2,691	\$2,193	\$4,111	\$3,169	\$2,476	\$2,099	\$1,848
2019	\$3,858	\$2,673	\$2,178	\$4,380	\$3,077	\$2,401	\$2,034	\$1,789
2020	\$3,948	\$2,737	\$2,230	\$4,803	\$3,003	\$2,341	\$1,981	\$1,741
2021	\$4,266	\$3,035	\$2,520	\$5,588	\$2,946	\$2,295	\$1,941	\$1,705
2022	\$4,377	\$3,114	\$2,586	\$5,734	\$3,056	\$2,414	\$2,066	\$1,833
2023	\$4,475	\$3,184	\$2,644	\$5,916	\$3,018	\$2,384	\$2,040	\$1,810
2024	\$4,553	\$3,240	\$2,691	\$6,020	\$2,987	\$2,360	\$2,019	\$1,792
2025	\$4,606	\$3,277	\$2,722	\$6,122	\$2,961	\$2,340	\$2,002	\$1,776
2026	\$4,659	\$3,315	\$2,753	\$6,192	\$2,943	\$2,325	\$1,989	\$1,765
2027	\$4,693	\$3,339	\$2,773	\$6,258	\$2,926	\$2,312	\$1,978	\$1,755
2028	\$4,747	\$3,377	\$2,805	\$6,330	\$2,913	\$2,301	\$1,969	\$1,747
2029	\$4,789	\$3,407	\$2,830	\$6,410	\$2,902	\$2,292	\$1,961	\$1,740
2030	\$4,853	\$3,453	\$2,867	\$6,495	\$2,894	\$2,286	\$1,956	\$1,736

\* = Amounts have been reduced by the \$500,000 state tax credit cap

Table J-39. Replacement Resource Capital Cost Assumptions: Maui, Lana'i, Moloka'i, Hawai'i Island 2016–2030 (1a of 2)



## J. Modeling Assumptions Data

Resource Capital Costs

### New Resource Cost Assumptions: Maui, Lana'i, Moloka'i, Hawai'i Island (1b of 2)

Hawai'i specific nominal overnight capital cost \$/kW<sub>AC</sub> (without AFUDC)

Nominal \$/kW	Replacement Resource Capital Cost Assumptions (without AFUDC): Maui, Lana'i, Moloka'i, Hawai'i Island							
	Onshore Wind*	Onshore Wind*	Onshore Wind*	Onshore Wind*	Utility-Scale Solar PV*	Utility-Scale Solar PV*	Utility-Scale Solar PV*	Utility-Scale Solar PV*
Technology	Onshore Wind*	Onshore Wind*	Onshore Wind*	Onshore Wind*	Utility-Scale Solar PV*	Utility-Scale Solar PV*	Utility-Scale Solar PV*	Utility-Scale Solar PV*
Size (MW)	10	20	30	1 (10 x 100 kW)	1	5	10	20
Fuel	n/a	n/a	n/a	n/a	n/a	n/a	n/a	n/a
Source	IHS, RSMMeans	IHS, RSMMeans	IHS, RSMMeans	Indicative quote from NPS + install estimate	IHS, RSMMeans	IHS, RSMMeans	IHS, RSMMeans	IHS, RSMMeans
Island	Hawai'i Maui	Hawai'i Maui	Hawai'i Maui	Lana'i Moloka'i	Lana'i Moloka'i	Hawai'i Maui	Hawai'i Maui	Hawai'i Maui
2031	\$4,892	\$3,481	\$2,891	\$6,571	\$2,886	\$2,280	\$1,951	\$1,731
2032	\$4,950	\$3,522	\$2,925	\$6,649	\$2,879	\$2,274	\$1,946	\$1,727
2033	\$4,992	\$3,552	\$2,949	\$6,727	\$2,871	\$2,268	\$1,941	\$1,722
2034	\$5,051	\$3,594	\$2,984	\$6,807	\$2,864	\$2,262	\$1,936	\$1,718
2035	\$5,093	\$3,624	\$3,010	\$6,887	\$2,856	\$2,256	\$1,931	\$1,713
2036	\$5,154	\$3,667	\$3,045	\$6,968	\$2,849	\$2,250	\$1,925	\$1,709
2037	\$5,198	\$3,698	\$3,071	\$7,051	\$2,841	\$2,244	\$1,920	\$1,704
2038	\$5,259	\$3,742	\$3,107	\$7,134	\$2,834	\$2,239	\$1,915	\$1,700
2039	\$5,304	\$3,774	\$3,134	\$7,218	\$2,826	\$2,233	\$1,910	\$1,695
2040	\$5,367	\$3,819	\$3,171	\$7,303	\$2,819	\$2,227	\$1,905	\$1,691
2041	\$5,414	\$3,852	\$3,199	\$7,389	\$2,811	\$2,221	\$1,900	\$1,686
2042	\$5,478	\$3,897	\$3,237	\$7,477	\$2,804	\$2,215	\$1,895	\$1,682
2043	\$5,525	\$3,931	\$3,265	\$7,565	\$2,796	\$2,209	\$1,890	\$1,677
2044	\$5,591	\$3,978	\$3,303	\$7,654	\$2,789	\$2,203	\$1,885	\$1,673
2045	\$5,640	\$4,013	\$3,333	\$7,744	\$2,782	\$2,198	\$1,880	\$1,669

\* = Amounts have been reduced by the \$500,000 state tax credit cap

Table J-40. Replacement Resource Capital Cost Assumptions: Maui, Lana'i, Moloka'i, Hawai'i Island 2031–2045 (1b of 2)

### New Resource Cost Assumptions: Maui, Lana'i, Moloka'i, Hawai'i Island (2a of 2)

Hawai'i specific nominal overnight capital cost \$/kW<sub>AC</sub> (without AFUDC)

Nominal \$/kW	Replacement Resource Capital Cost Assumptions (without AFUDC): Maui, Lana'i, Moloka'i, Hawai'i Island						
	Technology	Solar DG-PV	Simple Cycle Gas	Biomass	Biomass	Geothermal	Internal Combustion
Size (MW)	Varies	20.5	1	20	20	1	9
Fuel	n/a	Gas / Oil	Biomass	Biomass	n/a	Oil	Gas / Oil
Source	IHS, RSMMeans	NextEra	HECO Research of Comparable Plants	NREL	NREL	NextEra	NextEra
Island	Hawai'i, Maui, Lana'i, Moloka'i	Hawai'i Maui	Lana'i, Moloka'i	Hawai'i Maui	Hawai'i Maui	Lana'i, Moloka'i	Hawai'i Maui
2016	\$3,985	\$3,586	\$8,334	\$6,296	\$8,804	\$10,394	\$5,407
2017	\$3,753	\$3,634	\$8,064	\$6,092	\$8,963	\$10,532	\$5,479
2018	\$3,609	\$3,655	\$8,179	\$6,178	\$9,124	\$10,593	\$5,510
2019	\$3,492	\$3,702	\$8,298	\$6,269	\$9,289	\$10,731	\$5,582
2020	\$3,394	\$3,747	\$8,411	\$6,354	\$9,456	\$10,859	\$5,649
2021	\$3,318	\$3,795	\$8,533	\$6,446	\$9,626	\$11,000	\$5,722
2022	\$3,251	\$3,844	\$8,659	\$6,541	\$9,799	\$11,142	\$5,796
2023	\$3,192	\$3,892	\$8,781	\$6,633	\$9,976	\$11,280	\$5,868
2024	\$3,142	\$3,936	\$8,902	\$6,725	\$10,155	\$11,408	\$5,935
2025	\$3,100	\$3,981	\$9,036	\$6,826	\$10,338	\$11,540	\$6,003
2026	\$3,065	\$4,023	\$9,158	\$6,918	\$10,524	\$11,661	\$6,066
2027	\$3,034	\$4,082	\$9,291	\$7,019	\$10,713	\$11,832	\$6,155
2028	\$3,007	\$4,140	\$9,427	\$7,121	\$10,906	\$12,000	\$6,243
2029	\$2,982	\$4,194	\$9,560	\$7,222	\$11,103	\$12,157	\$6,324
2030	\$2,962	\$4,251	\$9,694	\$7,323	\$11,302	\$12,322	\$6,410

Table J-41. Replacement Resource Capital Cost Assumptions: Maui, Lana'i, Moloka'i, Hawai'i Island 2016–2030 (2a of 2)

**J. Modeling Assumptions Data**

Resource Capital Costs

**New Resource Cost Assumptions: Maui, Lana'i, Moloka'i, Hawai'i Island (2b of 2)**

Hawai'i specific nominal overnight capital cost \$/kW<sub>AC</sub> (without AFUDC)

Nominal \$/kW	Replacement Resource Capital Cost Assumptions (without AFUDC): Maui, Lana'i, Moloka'i, Hawai'i Island						
	Technology	Solar DG-PV	Simple Cycle Gas	Biomass	Biomass	Geothermal	Internal Combustion
Size (MW)	Varies	20.5	1	20	20	1	9
Fuel	n/a	Gas / Oil	Biomass	Biomass	n/a	Oil	Gas / Oil
Source	IHS, RSMMeans	NextEra	HECO Research of Comparable Plants	NREL	NREL	NextEra	NextEra
Island	Hawai'i, Maui, Lana'i, Moloka'i	Hawai'i Maui	Lana'i, Moloka'i	Hawai'i Maui	Hawai'i Maui	Lana'i, Moloka'i	Hawai'i Maui
2031	\$2,955	\$4,311	\$9,829	\$7,425	\$11,506	\$12,494	\$6,500
2032	\$2,947	\$4,371	\$9,966	\$7,528	\$11,713	\$12,668	\$6,590
2033	\$2,939	\$4,436	\$10,111	\$7,638	\$11,924	\$12,856	\$6,688
2034	\$2,931	\$4,499	\$10,250	\$7,743	\$12,138	\$13,040	\$6,783
2035	\$2,924	\$4,571	\$10,391	\$7,850	\$12,357	\$13,250	\$6,893
2036	\$2,916	\$4,641	\$10,527	\$7,952	\$12,579	\$13,453	\$6,998
2037	\$2,908	\$4,717	\$10,673	\$8,062	\$12,806	\$13,672	\$7,112
2038	\$2,901	\$4,792	\$10,810	\$8,166	\$13,036	\$13,890	\$7,226
2039	\$2,893	\$4,873	\$10,944	\$8,267	\$13,271	\$14,123	\$7,347
2040	\$2,885	\$4,947	\$11,068	\$8,361	\$13,510	\$14,338	\$7,459
2041	\$2,878	\$5,036	\$11,267	\$8,512	\$13,753	\$14,596	\$7,593
2042	\$2,870	\$5,126	\$11,470	\$8,665	\$14,001	\$14,859	\$7,730
2043	\$2,863	\$5,219	\$11,677	\$8,821	\$14,253	\$15,126	\$7,869
2044	\$2,855	\$5,313	\$11,887	\$8,979	\$14,509	\$15,398	\$8,010
2045	\$2,848	\$5,408	\$12,101	\$9,141	\$14,770	\$15,676	\$8,154

Table J-42. Replacement Resource Capital Cost Assumptions: Maui, Lana'i, Moloka'i, Hawai'i Island 2031–2045 (2b of 2)

**Replacement Resource Construction Expenditure Profiles: O’ahu**

Replacement Resource Construction Expenditure Profiles: O’ahu							
Years Before Commercial Operation Date	Onshore Wind	Offshore Wind Floating Platform	Onshore Wind + Cable	Onshore Wind + Cable	Utility-Scale Solar PV	Solar DG-PV	CSP w/ 10 Hours Storage
-5	00%	00%	00%	00%	00%	n/a	00%
-4	00%	00%	00%	00%	00%	n/a	00%
-3	00%	20%	20%	20%	00%	n/a	00%
-2	10%	40%	40%	40%	10%	n/a	10%
-1	90%	40%	40%	40%	90%	n/a	90%
Total COD	100%	100%	100%	100%	100%	n/a	100%

Table J-43. Replacement Resource Construction Expenditure Profiles: O’ahu (1 of 2)

Replacement Resource Construction Expenditure Profiles: O’ahu							
Years Before Commercial Operation Date	Combined Cycle Gas	Combined Cycle Gas	Simple Cycle Gas	Biomass	Internal Combustion	Internal Combustion	Internal Combustion
-5	00%	00%	00%	00%	00%	00%	00%
-4	15%	10%	00%	00%	00%	00%	00%
-3	35%	35%	15%	00%	15%	15%	00%
-2	35%	40%	65%	10%	65%	65%	65%
-1	15%	15%	20%	90%	20%	20%	35%
Total COD	100%	100%	100%	100%	100%	100%	100%

Table J-44. Replacement Resource Construction Expenditure Profiles: O’ahu (2 of 2)

## J. Modeling Assumptions Data

Resource Capital Costs

### Replacement Resource Construction Expenditure Profiles: Maui, Lana'i, Moloka'i, Hawai'i Island

Replacement Resource Construction Expenditure Profiles: Maui, Lana'i, Moloka'i, Hawai'i Island								
Years Before Commercial Operation Date	Onshore Wind	Onshore Wind	Onshore Wind	Onshore Wind	Utility-Scale Solar PV	Utility-Scale Solar PV	Utility-Scale Solar PV	Utility-Scale Solar PV
-5	00%	00%	00%	00%	00%	00%	00%	00%
-4	00%	00%	00%	00%	00%	00%	00%	00%
-3	00%	00%	00%	00%	00%	00%	00%	00%
-2	10%	10%	10%	00%	00%	10%	10%	10%
-1	90%	90%	90%	100%	100%	90%	90%	90%
Total COD	100%	100%	100%	100%	100%	100%	100%	100%

Table J-45. Replacement Resource Construction Expenditure Profiles: Maui, Lana'i, Moloka'i, Hawai'i Island (1 of 2)

Replacement Resource Construction Expenditure Profiles: Maui, Lana'i, Moloka'i, Hawai'i Island							
Years Before Commercial Operation Date	Solar DG-PV	Simple Cycle Gas	Biomass	Biomass	Geothermal	Internal Combustion	Internal Combustion
-5	n/a	00%	00%	00%	00%	00%	00%
-4	n/a	00%	00%	00%	00%	00%	00%
-3	n/a	20%	25%	20%	00%	25%	20%
-2	n/a	65%	60%	65%	40%	60%	65%
-1	n/a	15%	15%	15%	60%	15%	15%
Total COD	n/a	100%	100%	100%	100%	100%	100%

Table J-46. Replacement Resource Construction Expenditure Profiles: Maui, Lana'i, Moloka'i, Hawai'i Island (2 of 2)

## Energy Storage Cost Assumptions: Inertia and Contingency Applications

Capital cost in nominal \$/kWh (without AFUDC or interconnection costs)

Nominal \$/kWh	Energy Storage Cost Assumptions: Inertia and Contingency Applications					
	Inertia	Contingency				
Application						
Size (MW)	10	1	5	20	50	100
Technology	Flywheel	Lithium-Ion				
Duration Hours	0.25	0.5				
Turnaround Efficiency	85%	81%				
Discharge Cycles Per Year	15,000	Up to 10				
Depth of Discharge	100%	Up to 100%				
Plant Life Years	15%	15				
2016	\$9,400	\$1,506	\$1,506	\$1,506	\$1,506	\$1,506
2017	\$8,632	\$1,383	\$1,383	\$1,383	\$1,383	\$1,383
2018	\$7,877	\$1,262	\$1,262	\$1,262	\$1,262	\$1,262
2019	\$7,253	\$1,162	\$1,162	\$1,162	\$1,162	\$1,162
2020	\$6,729	\$1,078	\$1,078	\$1,078	\$1,078	\$1,078
2021	\$6,317	\$1,012	\$1,012	\$1,012	\$1,012	\$1,012
2022	\$5,972	\$957	\$957	\$957	\$957	\$957
2023	\$5,678	\$910	\$910	\$910	\$910	\$910
2024	\$5,429	\$870	\$870	\$870	\$870	\$870
2025	\$5,214	\$835	\$835	\$835	\$835	\$835
2026	\$5,029	\$806	\$806	\$806	\$806	\$806
2027	\$4,869	\$780	\$780	\$780	\$780	\$780
2028	\$4,730	\$758	\$758	\$758	\$758	\$758
2029	\$4,609	\$738	\$738	\$738	\$738	\$738
2030	\$4,503	\$721	\$721	\$721	\$721	\$721

Table J-47. Energy Storage Cost Assumptions: Inertia and Contingency Applications 2016–2030 (1 of 2)

**J. Modeling Assumptions Data**

Resource Capital Costs

**Energy Storage Cost Assumptions: Inertia and Contingency Applications (2 of 2)**

Capital cost in nominal \$/kWh (without AFUDC or interconnection costs)

Nominal \$/kWh	Energy Storage Cost Assumptions: Inertia and Contingency Applications					
	Inertia	Contingency				
Application						
Size (MW)	10	1	5	20	50	100
Technology	Flywheel	Lithium-Ion				
Duration Hours	0.25	0.5				
Turnaround Efficiency	85%	81%				
Discharge Cycles Per Year	15,000	Up to 10				
Depth of Discharge	100%	Up to 100%				
Plant Life Years	15%	15				
2031	\$4,409	\$706	\$706	\$706	\$706	\$706
2032	\$4,327	\$693	\$693	\$693	\$693	\$693
2033	\$4,255	\$682	\$682	\$682	\$682	\$682
2034	\$4,190	\$671	\$671	\$671	\$671	\$671
2035	\$4,133	\$662	\$662	\$662	\$662	\$662
2036	\$4,083	\$654	\$654	\$654	\$654	\$654
2037	\$4,038	\$647	\$647	\$647	\$647	\$647
2038	\$3,998	\$641	\$641	\$641	\$641	\$641
2039	\$3,962	\$635	\$635	\$635	\$635	\$635
2040	\$3,930	\$630	\$630	\$630	\$630	\$630
2041	\$3,902	\$625	\$625	\$625	\$625	\$625
2042	\$3,876	\$621	\$621	\$621	\$621	\$621
2043	\$3,854	\$617	\$617	\$617	\$617	\$617
2044	\$3,833	\$614	\$614	\$614	\$614	\$614
2045	\$3,815	\$611	\$611	\$611	\$611	\$611

Table J-48. Energy Storage Cost Assumptions: Inertia and Contingency Applications 2031–2045 (2 of 2)

## Energy Storage Cost Assumptions: Regulation / Renewable Smoothing Applications

Capital cost in nominal \$/kWh (without AFUDC or interconnection costs)

Nominal \$/kWh	Energy Storage Cost Assumptions: Regulation / Renewable Smoothing Applications				
Size (MW)	1	5	20	50	100
Technology	Lithium-Ion				
Duration Hours	1.0				
Turnaround Efficiency	81%				
Discharge Cycles Per Year	Up to 15,000				
Depth of Discharge	Up to 20%				
Plant Life Years	15				
2016	\$1,083	\$1,083	\$1,083	\$1,083	\$1,083
2017	\$999	\$999	\$999	\$999	\$999
2018	\$914	\$914	\$914	\$914	\$914
2019	\$843	\$843	\$843	\$843	\$843
2020	\$782	\$782	\$782	\$782	\$782
2021	\$737	\$737	\$737	\$737	\$737
2022	\$698	\$698	\$698	\$698	\$698
2023	\$666	\$666	\$666	\$666	\$666
2024	\$638	\$638	\$638	\$638	\$638
2025	\$614	\$614	\$614	\$614	\$614
2026	\$594	\$594	\$594	\$594	\$594
2027	\$576	\$576	\$576	\$576	\$576
2028	\$560	\$560	\$560	\$560	\$560
2029	\$547	\$547	\$547	\$547	\$547
2030	\$535	\$535	\$535	\$535	\$535

Table J-49. Energy Storage Cost Assumptions: Regulation / Renewable Smoothing 2016–2030 (1 of 2)



**J. Modeling Assumptions Data**

Resource Capital Costs

**Energy Storage Cost Assumptions: Regulation / Renewable Smoothing Applications (2 of 2)**

Capital cost in nominal \$/kWh (without AFUDC or interconnection costs)

Nominal \$/kWh	Energy Storage Cost Assumptions: Regulation / Renewable Smoothing Applications				
Size (MW)	1	5	20	50	100
Technology	Lithium-Ion				
Duration Hours	1.0				
Turnaround Efficiency	81%				
Discharge Cycles Per Year	Up to 15,000				
Depth of Discharge	Up to 20%				
Plant Life Years	15				
2031	\$525	\$525	\$525	\$525	\$525
2032	\$516	\$516	\$516	\$516	\$516
2033	\$508	\$508	\$508	\$508	\$508
2034	\$500	\$500	\$500	\$500	\$500
2035	\$494	\$494	\$494	\$494	\$494
2036	\$488	\$488	\$488	\$488	\$488
2037	\$483	\$483	\$483	\$483	\$483
2038	\$479	\$479	\$479	\$479	\$479
2039	\$475	\$475	\$475	\$475	\$475
2040	\$471	\$471	\$471	\$471	\$471
2041	\$468	\$468	\$468	\$468	\$468
2042	\$465	\$465	\$465	\$465	\$465
2043	\$463	\$463	\$463	\$463	\$463
2044	\$461	\$461	\$461	\$461	\$461
2045	\$459	\$459	\$459	\$459	\$459

Table J-50. Energy Storage Cost Assumptions: Regulation / Renewable Smoothing Applications 2031–2045 (2 of 2)

## Energy Storage Cost Assumptions: Load Shifting and Grid Support Applications

Capital cost in nominal \$/kWh (without AFUDC or interconnection costs)

Nominal \$/kWh	Energy Storage Cost Assumptions: Load Shifting and Grid Support Applications					
	Load Shifting					Grid Support
Application						
Size (MW)	1	5	20	50	100	5
Technology	Lithium-Ion					Lithium-Ion
Duration Hours	4.0					2.0
Turnaround Efficiency	88%					81%
Discharge Cycles Per Year	Up to 365					Up to 365
Depth of Discharge	Up to 100%					Up to 100%
Plant Life Years	15					15
2016	\$660	\$660	\$660	\$660	\$660	\$1,083
2017	\$615	\$615	\$615	\$615	\$615	\$999
2018	\$565	\$565	\$565	\$565	\$565	\$914
2019	\$524	\$524	\$524	\$524	\$524	\$843
2020	\$487	\$487	\$487	\$487	\$487	\$782
2021	\$461	\$461	\$461	\$461	\$461	\$737
2022	\$440	\$440	\$440	\$440	\$440	\$698
2023	\$422	\$422	\$422	\$422	\$422	\$666
2024	\$406	\$406	\$406	\$406	\$406	\$638
2025	\$393	\$393	\$393	\$393	\$393	\$614
2026	\$382	\$382	\$382	\$382	\$382	\$594
2027	\$372	\$372	\$372	\$372	\$372	\$576
2028	\$363	\$363	\$363	\$363	\$363	\$560
2029	\$355	\$355	\$355	\$355	\$355	\$547
2030	\$349	\$349	\$349	\$349	\$349	\$535

Table J-51. Energy Storage Cost Assumptions: Load Shifting and Grid Support Applications 2016–2030 (1 of 2)

**J. Modeling Assumptions Data**

Resource Capital Costs

**Energy Storage Cost Assumptions: Load Shifting and Grid Support Applications (2 of 2)**

Capital cost in nominal \$/kWh (without AFUDC or interconnection costs)

Nominal \$/kWh	Energy Storage Cost Assumptions: Load Shifting and Grid Support Applications					
	Load Shifting					Grid Support
Application						
Size (MW)	1	5	20	50	100	5
Technology	Lithium-Ion					Lithium-Ion
Duration Hours	4.0					2.0
Turnaround Efficiency	88%					81%
Discharge Cycles Per Year	Up to 365					Up to 365
Depth of Discharge	Up to 100%					Up to 100%
Plant Life Years	15					15
2031	\$343	\$343	\$343	\$343	\$343	\$525
2032	\$338	\$338	\$338	\$338	\$338	\$516
2033	\$333	\$333	\$333	\$333	\$333	\$508
2034	\$329	\$329	\$329	\$329	\$329	\$500
2035	\$326	\$326	\$326	\$326	\$326	\$494
2036	\$323	\$323	\$323	\$323	\$323	\$488
2037	\$320	\$320	\$320	\$320	\$320	\$483
2038	\$317	\$317	\$317	\$317	\$317	\$479
2039	\$315	\$315	\$315	\$315	\$315	\$475
2040	\$313	\$313	\$313	\$313	\$313	\$471
2041	\$312	\$312	\$312	\$312	\$312	\$468
2042	\$310	\$310	\$310	\$310	\$310	\$465
2043	\$309	\$309	\$309	\$309	\$309	\$463
2044	\$307	\$307	\$307	\$307	\$307	\$461
2045	\$306	\$306	\$306	\$306	\$306	\$459

Table J-52. Energy Storage Cost Assumptions: Load Shifting and Grid Support Applications 2031–2045 (2 of 2)

## Energy Storage Cost Assumptions: Residential, Commercial, and Long Duration Load Shifting Applications

Capital cost in nominal \$/kWh (without AFUDC or interconnection costs)

Nominal \$/kWh	Energy Storage Cost Assumptions: Residential, Commercial, and Long Duration Load Shifting Applications						
	Residential		Commercial		Long Duration Load Shifting		
Application	Residential		Commercial		Long Duration Load Shifting		
Size (MW)	0.002		0.050	1.000	30.000	30.000	50.000
Technology	Lithium-Ion w/o inverter	Lithium-Ion w/ inverter & Balance of Plant	Lithium-Ion		Lithium-Ion	Pumped-Storage Hydro	
Duration Hours	4.0		2.0		6.0		
Turnaround Efficiency	88%		88%		80%		
Discharge Cycles Per Year	Up to 365		Up to 365		Up to 365		
Depth of Discharge	Up to 100%		Up to 100%		Up to 100%		
Plant Life Years	10		10		15	40	
2016	\$506	\$1,026	\$553	\$553	\$530	\$583	\$583
2017	\$465	\$961	\$511	\$511	\$493	\$594	\$594
2018	\$416	\$884	\$461	\$461	\$454	\$605	\$605
2019	\$373	\$817	\$417	\$417	\$421	\$615	\$615
2020	\$335	\$757	\$378	\$378	\$391	\$626	\$626
2021	\$317	\$729	\$359	\$359	\$371	\$638	\$638
2022	\$303	\$706	\$342	\$342	\$353	\$649	\$649
2023	\$290	\$687	\$328	\$328	\$339	\$661	\$661
2024	\$280	\$670	\$316	\$316	\$326	\$673	\$673
2025	\$270	\$655	\$305	\$305	\$316	\$685	\$685
2026	\$262	\$643	\$296	\$296	\$306	\$697	\$697
2027	\$256	\$632	\$289	\$289	\$298	\$710	\$710
2028	\$250	\$623	\$282	\$282	\$291	\$723	\$723
2029	\$245	\$615	\$276	\$276	\$285	\$736	\$736
2030	\$240	\$608	\$271	\$271	\$280	\$749	\$749

Table J-53. Energy Storage Cost Assumptions: Residential, Commercial, and Long Duration Load Shifting Applications  
2016–2030 (1 of 2)

## J. Modeling Assumptions Data

Resource Capital Costs

### Energy Storage Cost Assumptions: Residential, Commercial, and Long Duration Load Shifting Applications (2 of 2)

Capital cost in nominal \$/kWh (without AFUDC or interconnection costs)

Nominal \$/kWh	Energy Storage Cost Assumptions: Residential, Commercial, and Long Duration Load Shifting Applications						
	Residential		Commercial		Long Duration Load Shifting		
Application	Residential		Commercial		Long Duration Load Shifting		
Size (MW)	0.002		0.050	1.000	30.000	30.000	50.000
Technology	Lithium-Ion w/o inverter	Lithium-Ion w/ inverter & Balance of Plant	Lithium-Ion		Lithium-Ion	Pumped-Storage Hydro	
Duration Hours	4.0		2.0		6.0		
Turnaround Efficiency	88%		88%		80%		
Discharge Cycles Per Year	Up to 365		Up to 365		Up to 365		
Depth of Discharge	Up to 100%		Up to 100%		Up to 100%		
Plant Life Years	10		10		15	40	
2031	\$236	\$601	\$267	\$267	\$275	\$762	\$762
2032	\$232	\$596	\$263	\$263	\$271	\$776	\$776
2033	\$229	\$591	\$259	\$259	\$268	\$790	\$790
2034	\$227	\$587	\$256	\$256	\$264	\$804	\$804
2035	\$224	\$583	\$253	\$253	\$262	\$819	\$819
2036	\$222	\$579	\$251	\$251	\$259	\$833	\$833
2037	\$220	\$576	\$249	\$249	\$257	\$848	\$848
2038	\$218	\$574	\$247	\$247	\$255	\$864	\$864
2039	\$217	\$571	\$245	\$245	\$253	\$879	\$879
2040	\$216	\$569	\$243	\$243	\$252	\$895	\$895
2041	\$214	\$567	\$242	\$242	\$250	\$911	\$911
2042	\$213	\$565	\$241	\$241	\$249	\$928	\$928
2043	\$212	\$564	\$240	\$240	\$248	\$944	\$944
2044	\$211	\$563	\$239	\$239	\$247	\$961	\$961
2045	\$211	\$561	\$238	\$238	\$246	\$979	\$979

Table J-54. Energy Storage Cost Assumptions: Residential, Commercial, and Long Duration Load Shifting Applications 2030–2045 (2 of 2)

### Energy Storage Construction Expenditure Profiles: Inertia and Contingency Applications

All costs are for lithium-ion batteries.

Energy Storage Construction Expenditure Profiles: Inertia and Contingency Applications						
Application	Inertia	Contingency				
Years Before Commercial Operation Date	10 MW	1 MW	5 MW	20 MW	50 MW	100 MW
-6	00%	00%	00%	00%	00%	00%
-5	00%	00%	00%	00%	00%	00%
-4	00%	00%	00%	00%	00%	00%
-3	00%	00%	00%	00%	00%	00%
-2	20%	00%	00%	20%	20%	20%
-1	80%	100%	100%	80%	80%	80%
Total COD	100%	100%	100%	100%	100%	100%

Table J-55. Energy Storage Construction Expenditure Profiles: Inertia and Contingency Applications

### Energy Storage Construction Expenditure Profiles: Regulation/Renewable Smoothing Applications

All costs are for lithium-ion batteries.

Energy Storage Construction Expenditure Profiles: Inertia and Contingency Applications					
Application	Regulation/Renewable Smoothing				
Years Before Commercial Operation Date	1 MW	5 MW	20 MW	50 MW	100 MW
-6	00%	00%	00%	00%	00%
-5	0%	00%	00%	00%	00%
-4	00%	00%	00%	00%	00%
-3	00%	00%	00%	00%	00%
-2	00%	00%	20%	20%	20%
-1	100%	100%	80%	80%	80%
Total COD	100%	100%	100%	100%	100%

Table J-56. Energy Storage Construction Expenditure Profiles: Regulation/Renewable Smoothing Applications

## J. Modeling Assumptions Data

Resource Capital Costs

### Energy Storage Construction Expenditure Profiles: Load Shifting and Grid Support Applications

All costs are for lithium-ion batteries.

Energy Storage Construction Expenditure Profiles: Load Shifting and Grid Support Applications						
Application	Load Shifting					Grid Support
Years Before Commercial Operation Date	1 MW	5 MW	20 MW	50 MW	100 MW	5 MW
-6	00%	00%	00%	00%	00%	00%
-5	00%	00%	00%	00%	00%	00%
-4	00%	00%	00%	00%	00%	00%
-3	00%	00%	00%	00%	00%	00%
-2	00%	00%	20%	20%	30%	00%
-1	100%	100%	80%	80%	70%	100%
Total COD	100%	100%	100%	100%	100%	100%

Table J-57. Energy Storage Construction Expenditure Profiles: Load Shifting and Grid Support Applications

### Energy Storage Construction Expenditure Profiles: Residential, Commercial, and Long Duration Load Shifting Applications

Energy Storage Construction Expenditure Profiles: Residential, Commercial, and Long Duration Load Shifting Applications							
Application	Residential		Commercial		Long Duration Load Shifting		
Technology	Lithium-Ion w/o Inverter	Lithium-Ion w/ Inverter & Balance of Plant	Lithium-Ion		Lithium-Ion	Pumped-Storage Hydro	
Years Before Commercial Operation Date	0.002 MW		0.050 MW		30.000 MW		50.000 MW
-6	n/a	n/a	n/a	n/a	00%	5%	5%
-5	n/a	n/a	n/a	n/a	00%	10%	10%
-4	n/a	n/a	n/a	n/a	00%	10%	10%
-3	n/a	n/a	n/a	n/a	00%	20%	20%
-2	n/a	n/a	n/a	n/a	30%	30%	30%
-1	n/a	n/a	n/a	n/a	70%	25%	25%
Total COD	n/a	n/a	n/a	n/a	100%	100%	100%

Table J-58. Energy Storage Construction Expenditure Profiles: Residential, Commercial, and Long Duration Load Shifting Applications

## DEMAND RESPONSE DATA

The Black & Veatch AP for Production Simulation model produces Demand Response (DR) modeling data to evaluate DR for reducing energy production costs, deferring capital expenditures, and improving grid stability. There are a number of key inputs and constraints unique to the Demand Response modeling data.

The primary modeling data assumptions originated from the Navigant Potential Study. The study forecasted the quantity of MW by customer class and end use device that the Companies can target in each DR program.

The end uses are identified in the following tables. Table J-59 lists the DR end uses for residential customers; Table J-60 lists the DR end uses for commercial, industrial, and small business customers.

Building Type	End Uses
Electric Vehicles	EV
Photovoltaics	PV
Residential	Cooling, water heating, and other
Storage	Storage paired with PV and Standalone Storage

Table J-59. DR End Uses for Residential Customers

Customer Storage is an End Use for Residential customers, as well as other building types. Storage was not forecasted in the gross load profile. In the interim DR filing, the gross load profile did include customer storage, but the PSIP modeling assumed no customer storage as the base case, the case to build on. BCG has created a econometrics model to better forecast customer uptake of customer storage based on the customers payback period, provided DR incentives or reduced price and other state and federal incentives. The forecasted number for customer storage is added into each DR portfolio case, but because each case is different, we were not able to consistently settle on one case for DR or storage. Once all inputs for the Preferred Case are accepted, the forecasted Customer Storage potential will be locked in with the entire DR portfolio potential.



## J. Modeling Assumptions Data

### Demand Response Data

Building Type	End Uses
Storage	Storage paired with PV and Standalone Storage
Education	Cooling, lighting, ventilation, water heating, and other
Electric Vehicles	EV
Grocery	Cooling, lighting, ventilation, water heating, and other
Health	Cooling, lighting, ventilation, water heating, and other
Hotel	Cooling, lighting, ventilation, water heating, and other
Industrial	Whole facility
Large Multi-Family	Cooling, lighting, water heating, and other
Military	Cooling, heating, lighting, ventilation, water heating, and other
Office	Cooling, heating, lighting, ventilation, water heating, and other
Photovoltaics	PV
Restaurant	Cooling, lighting, ventilation, water heating, and other
Retail	Cooling, heating, lighting, ventilation, water heating, and other
Warehouse	Whole facility
Water Pumping	Whole facility

Table J-60. DR End Uses for Commercial, Industrial, and Small Business Customers

The Navigant Potential Study determined the maximum achievable potential of end-use devices to provide specific services (fast frequency response, non-spin auto response, regulating reserves, load building, and load reduction) through specific DR programs (time of use, day ahead load shift, real-time pricing, critical peak incentive, minimum load building, fast frequency response, non-spin auto response, and regulating reserves). AP for Production Simulation uses annual weekday and weekend potential data by DR program, customer class, building type, and end use. Figure J-33 shows the potential, under available programs, to decrease load using the cooling end use available from military buildings on O’ahu. It is a snapshot based on a weekday during September 2030.

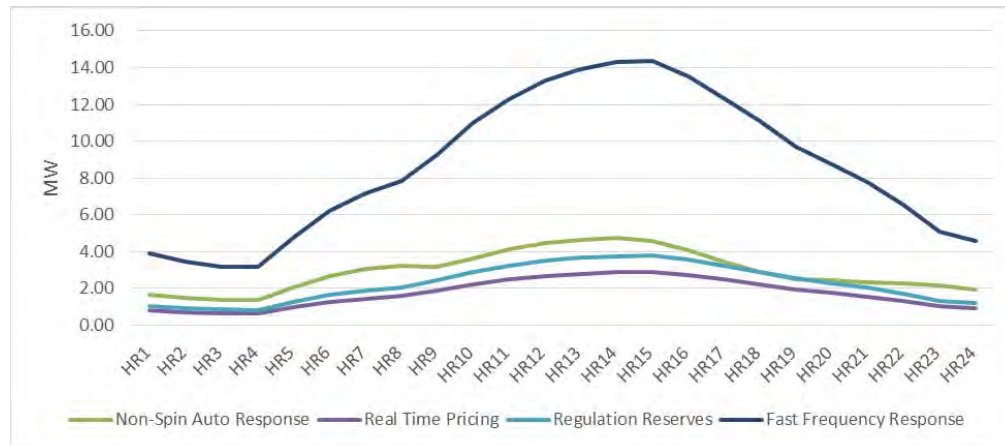

Figure J-33. Example Load Decrease Potential Supporting DR Programs

In general, DR programs grow over time. Figure J-34 shows how Regulation Reserves potential considering all customer classes and all end uses on O’ahu is expected to increase between 2018 (the first year available) and 2045. This data also represents a September weekday snapshot.

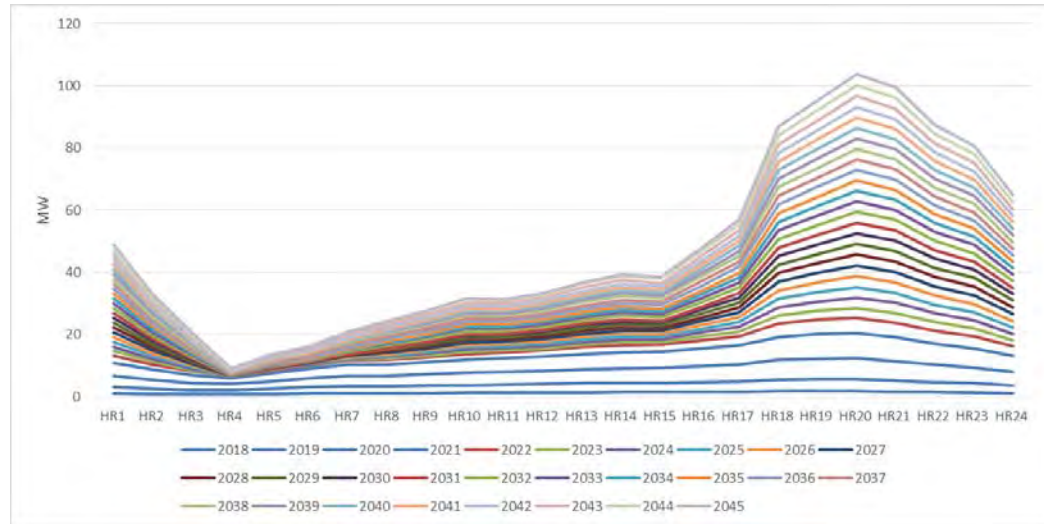

Figure J-34. Example O’ahu Regulating Reserve DR Program Growth over Time

The projected demand profiles (provided by the Companies) are another key input to the DR evaluation. Daily demand dictates the potential for DR programs. For example, air conditioning loads increase on hot days, thereby providing greater potential for air conditioners to participate in a DR program.

AP for Production Simulation also includes system security constraints (provided by the Companies) for DR to improve grid stability specifically for O’ahu. These constraints focus on eliminating under-frequency load shedding (UFLS) after a contingency event such as a unit trip. The constraints include data on net system load, kinetic energy, and the largest contingency. This data enables AP for Production Simulation to determine the amount of Grid Service Fast Frequency Response and segregated customer end-use devices necessary to handle a contingency. Kinetic energy by unit is included in Table J-61. O’ahu’s largest contingency unit is, prior to retirement, AES, Kahe 5, then Kahe 6.

## J. Modeling Assumptions Data

### Demand Response Data

Unit	Kinetic Energy (MW-Sec)	Unit	Kinetic Energy (MW-sec)
HPOWER-1	209	Waiau 3	259
HPOWER-2	144	Waiau 4	259
AES	615	Waiau 5	261
Kalaeloa CT-1	591	Waiau 6	256
Kalaeloa ST	287	Waiau 7	426
Kalaeloa CT-2	591	Waiau 8	426
Kahe 1	426	Waiau 9	447
Kahe 2	426	Waiau 10	447
Kahe 3	357	Schofield 1	11
Kahe 4	357	Schofield 2	11
Kahe 5	692	Schofield 3	11
Kahe 6	692	Schofield 4	11
CIPI	765	Schofield 5	11
Honolulu 8	124	Schofield 6	11
Honolulu 9	125	n/a	n/a

Table J-61. Kinetic Energy by Unit for O'ahu in 2019

## Demand Response Portfolio

A portfolio of DR programs is under development. While a preliminary, interim program portfolio application was filed on December 30, 2015, that portfolio is currently being revised, an updated application will be filed February 10, 2017. The information below reflects both the current state of the DR portfolio, pending final refinements prior to the final DR program portfolio application. The sections that follow describe each proposed DR program, the methodology for calculating program costs, the methodology for determining the avoided costs associated with the portfolio (the means of reducing system costs if replaced with DR), and the targeted MWs to be utilized by the Companies.

## Demand Response Programs

The DR program portfolio application presented a suite of DR programs that are candidates for the portfolio. Each of the nine DR programs was designed to deliver a specific grid service. The figure below has been updated since the last PSIP filing and interim DR application,<sup>8</sup> to reflect the new grid service naming convention (FFR2 and Replacement Reserves).

<sup>8</sup> See Docket No. 2015-0412, Interim DR Program Portfolio Application filing, filed December 30, 2015.

DR Program	Grid Service Delivered
Real-Time Pricing (RTP)	Capacity
Time-of-Use (TOU)	
Day-Ahead Load Shift (DALs)	
Minimum Load (ML)	
PV Curtailment (PVC)	
Critical Peak Incentive (CPI)	
Fast Frequency Response (FRR)	Fast Frequency Response 1 and 2
Regulating Reserve (RegUp)	Regulating Reserve (RegUp)
Non-Spin Auto Response (NSAR)	Replacement Reserve (RR) (10-Minute)

Table J-62. DR Program to Grid Service Mapping

Descriptions of these programs follow.

**Real-Time Pricing.** RTP is a capacity grid service resource capable of providing hourly retail rate prices to customers up to six hours before the event day starts. Retail rates will be based on weather, system resource availability, and forecasted load profile. As mentioned earlier, the most operationally and cost-efficient way to deliver Residential RTP programs is with an AMI infrastructure in place.

**Time-of-Use.** TOU is a capacity grid service resource capable of providing a static period pricing rate for on-peak, off-peak, and mid-day times of the day to residential customers only. Customers are encouraged, through the price differential, to shift their energy usage from the peak time of day to the night or middle of the day, when solar PV is at its peak. Once RTP becomes available, TOU programs are expected to end and the participants will have an opportunity to transition into RTP.

**Day-Ahead Load Shift.** DALs is a capacity grid service resource capable of providing a static period pricing rate are delivered six hours before the event start day for on-peak, off-peak, and mid-day times of the day to commercial customers only. Customers are encouraged, through the price differential, to shift their energy usage from the peak time of day to the night or middle of the day, when solar PV is at its peak.

**Minimum Load.** ML is a capacity grid service resource capable of providing increased load in the middle of the day by incentivizing customers to shift their usage to the middle of the day. While identified as an option, this program was not used in any of the portfolios’ analysis because the benefits of load shifting programs, such as TOU, DALs, or RTP, were already fulfilling the load flattening benefits.

**PV Curtailment.** PVC is a capacity grid service resource capable of issuing curtailment of customer’s PV during times when minimum must run generators are within a specified threshold limit that requires more load on the system in order to prevent sudden shut down of an online generator. Additionally, PVC is expected to offer circuit-

## J. Modeling Assumptions Data

### Demand Response Data

level value in helping to address back-feeding risks as well as power quality and voltage issues. The Demand Response team will collaborate on the development of DER Phase 2 program design to help identify opportunities to incorporate specific PVC options.

**Critical Peak Pricing.** CPI is a capacity grid service resource capable of providing peak load reduction during emergency situations when not enough generation resources are available. The current existing Commercial DLC program could be re-classified under this program as part of the initial migration.

**Fast Frequency Response.** FFR program is a FFR grid service resource capable of responding to contingency events within 30 cycles or less.<sup>9</sup> A customer who enrolls in this program would have to be able to offer load resources that could respond to a local discrete response in 30 cycles or less.

**Regulating Reserve.** RegUp is a grid service resource capable of providing up and down reserves to balance the variability of the system given high renewable penetration. A customer who enrolls in this program must be able to provide a load resource that could initiate a response within two seconds. The Companies examined RegDown as an additional program option, and while there are sufficient resources projected to be capable of delivering such a service, the modeling efforts undertaken did not demonstrate a significant value of this service based on the current resource mix expected to deliver that RegDown service.

**Non-Spin Auto Response.** NSAR is a 10-minute reserve capable of replacing other resources that are used for Replacement Reserves. Replacement Reserves may be used for restoring regulation or contingency reserves. A customer who is enrolled in this NSAR program would have 10-minutes to respond and reduce their enrolled load resource.

## Methodology for Determining Cost of DR Programs

For this PSIP Update, and subsequently for the updated DR program portfolio application, program costs have been developed using a bottom-up approach. This represents a change from the levelized, top-down approach taken during the DR interim application. These costs are embedded into the production cost models when performing optimization of base cases. The Companies will continue to refine cost assumptions in advance of the final DR application; providing the best possible 2-year proposed budget and 15-year avoided cost analysis.

---

<sup>9</sup> 30 cycles is the maximum FFR response requirement dependent on total MW available. The requirement may be less than 30 cycles after further analysis.

Finally, an inflation rate of 1.8% and annual replacement rate of 5% was used to calculate costs. The following is an excerpt from the Companies response to PSIP IR-40<sup>10</sup> regarding the method of calculating costs:

In the DR Interim Application, costs were determined using the leveled costs as part of the Potential Study (See Exhibit A of the DR Interim Application). In order to estimate and assess the cost effectiveness of the programs in its current status, a top down approach of leveled cost was used for the DR Interim Application. For the April PSIP Update and final DR Program Portfolio Application filing to be filed in Docket No. 2015-0412 later this year, a bottom-up approach will be used for a more accurate representation of the cost of each of the programs. Key to the bottom-up approach will be estimating the enabling cost of each customer, quantifying their material, incentive, and installation costs. The cost will then be multiplied by the number of customers expected to be enrolled in each program. Followed by additional costs such as labor, marketing, evaluation, and general outside services will then be added to complete the overall cost of the DR program portfolio. The MWs determined through the avoided cost analysis supports the number of customer appliances that are needed on each program. The number of expected customers will be derived and supported from the potential study and the avoided cost analysis update. These updates will be filed as exhibits in the upcoming final DR Program Portfolio Application to be filed in Docket No. 2015-0412 later this year.

Foundationally, historical DR costs incurred by the Companies have been used to calculate the necessary program costs for programs similar to those in the Companies' current portfolio. For program costs associated with proposed programs that are new to the Companies, such as RR<sup>11</sup>, responses to the Companies' Grid Services request for proposals, as well as data derived from mainland markets have been used to derive cost estimates."

The key to an accurate program cost projection is the DR Potential Study, which will continue to be updated during the process. While certain costs remain uncertain, such as incentive structures, the Companies have derived incentives from the avoided costs of the programs, less the anticipated administrative and operational costs. The Companies will continue to modify costs over time as programs are implemented and actual costs are tracked.

---

<sup>10</sup> Docket 2014-0183; *Companies' Response to Commission Information Requests*, at 7–8.

<sup>11</sup> RR has been renamed "RegUp".

## J. Modeling Assumptions Data

### Demand Response Data

The approach described above has already been undertaken, and the new program costs resulting from that process are as follows:

Island	NPV Cost
O'ahu	\$447,357,789
Maui	\$60,857,964
Hawai'i Island	\$75,679,815
Moloka'i	\$817,531
Lana'i	\$1,509,259
DRMS	\$13,414,991

Table J-63. DR Program Net Present Value Costs

These cost projections are for the E3 cases, but the DR Final Application may include multiple cost projections depending on a variety of resource plans.

## Methodology for Determining Avoided Costs of DR Programs

Avoided cost analysis for DR programs allows the Companies to compare the system costs of a base case with DR programs against the system costs of a base case without DR programs.

The following is an excerpt from the Demand Response Interim application:

Each program will be designed to provide resources that can either directly or in combination with other programs, replace a more costly resource. An iteration analyzing which combination presented the best cost-effective DR programs was performed in the Avoided Cost Analysis. The Avoided Cost analysis resulted in advancing programs that were beneficial for each island in terms of their relative benefit and ultimately their contribution to a cost beneficial portfolio... The cost-effectiveness analysis determined which islands were capable of implementing a cost-effective DR Portfolio, although further analysis is required before finalizing the entire portfolio of programs for each island.<sup>12</sup>

The Companies, in tandem with Black & Veatch modelers, have developed specific modeling techniques to evaluate the range of services provided by DR based on the characteristics of each service combined with the performance characteristics of the individual end uses. The methodology for calculating the avoided cost, as well as the specific modeling techniques is described in Appendix H, under the Adaptive Planning for Production Simulation description.

The avoided cost for a grid service is the cost of an alternative resource (energy storage or a generator) to provide the equivalent service. Avoided costs are based on several factors,

<sup>12</sup> Section IX of Docket 2015-0412 filed December 30, 2015

including installed capacity costs, fuel costs, and cost of alternatives, each of which depends on the current state of the system. Additionally, alterations to a base case capital plan promote meaningful avoided costs opportunities. In the context of the PSIP Update, the following represent examples of potential avoided cost values of DR across the different systems:

*O'ahu:* The DR portfolio enables reduction in size of the Contingency battery, improved heat rate performance and reduced fuel costs.

*Maui:* The DR portfolio enables improved heat rate performance and reduced fuel costs.

*Moloka'i:* The DR portfolio enables improved heat rate performance and reduced fuel costs.

*Lana'i:* The DR portfolio enables improved heat rate performance and reduced fuel costs.

*Hawai'i Island:* The DR portfolio enables improved heat rate performance and reduced fuel costs.

During the PSIP modeling process, multiple base cases were created, generating multiple DR portfolios. The DR portfolios include varying amounts of end device potentials, including customer storage, by year and island. Customer storage uptake forecasting is synergistic with DR portfolio optimization, and the resource is considered as a DR end use capable of providing multiple grid services.

The DR portfolio development started with no DR resource base cases, then created the DR portfolio from each base case, but did not add that new portfolio into the base case, unless that base case would proceed towards a cost beneficial plan. Optimization of the DR portfolio will be performed in the next iteration. The final cost, avoided cost and cost effectiveness analysis will utilize the optimized DR portfolio and include it within the Final DR Application, anticipated for filing February 10, 2017.



## J. Modeling Assumptions Data

Demand Response Data

### DR Grid Service Portfolio: O'ahu

Customer	Commercial		
Program	Regulating Reserves	Fast Frequency Response	Pricing
Grid Service	RegUp	FFR	Capacity
Frequency	Continuous	Contingency Event	Daily
Event Length	30 minutes	10 minutes	24 hours
Year	MW	MW	MW
2016	–	–	–
2017	–	–	–
2018	0.45	18.40	-
2019	1.44	19.11	-
2020	3.10	17.27	27.18
2021	6.82	18.98	29.86
2022	9.92	21.25	32.42
2023	12.78	23.61	35.00
2024	15.82	26.21	37.85
2025	18.98	29.11	41.13
2026	22.27	32.11	44.83
2027	25.66	35.23	48.56
2028	29.21	38.86	52.50
2029	32.80	42.28	56.61
2030	36.52	45.88	61.12
2031	40.32	49.50	66.85
2032	44.21	52.87	72.44
2033	48.09	56.61	78.18
2034	52.11	60.35	83.43
2035	56.13	64.18	88.66
2036	60.18	68.67	94.12
2037	64.23	72.73	90.13
2038	68.33	76.83	94.82
2039	72.50	80.94	99.57
2040	76.78	85.08	104.16
2041	80.97	89.27	108.79
2042	85.21	93.48	113.34
2043	89.48	97.75	118.08
2044	93.74	102.05	122.88
2045	98.10	106.31	127.60

Table J-64. O'ahu DR Program Grid Service Portfolio (1 of 2)

DR Grid Service Portfolio: O'ahu (2 of 2)

Customer	Residential			Small Business		
	Regulating Reserves	Fast Frequency Response	Pricing	Regulating Reserves	Fast Frequency Response	Pricing
Grid Service	RegUp	FFR	Capacity	RegUp	FFR	Capacity
Frequency	Continuous	Contingency Event	Daily	Continuous	Contingency Event	Daily
Event Length	30 minutes	10 minutes	24 hours	30 minutes	10 minutes	24 hours
Year	MW	MW	MW	MW	MW	MW
2016	–	–	–	–	–	–
2017	–	0.77	0.77	–	0.04	–
2018	4.74	20.35	3.96	0.38	1.39	0.09
2019	12.02	35.71	8.58	1.12	2.55	0.14
2020	20.77	43.95	41.69	2.11	3.61	10.65
2021	28.51	48.37	47.50	3.09	4.00	11.38
2022	32.88	51.73	53.76	3.88	4.56	12.13
2023	36.21	48.50	60.60	4.19	3.97	12.62
2024	39.76	54.01	67.31	4.53	4.38	13.30
2025	44.05	57.72	74.80	4.89	4.77	14.29
2026	51.12	67.94	84.47	5.27	5.21	15.21
2027	58.39	77.61	93.97	5.66	5.68	16.44
2028	65.89	83.18	103.37	6.08	6.35	17.88
2029	73.43	92.91	106.34	6.51	7.00	19.34
2030	81.23	100.85	114.20	6.96	7.68	21.30
2031	89.46	108.98	122.41	7.44	8.36	23.87
2032	97.84	117.30	130.80	7.95	9.22	26.31
2033	106.40	125.78	139.16	8.44	10.82	29.24
2034	115.14	134.44	147.43	8.91	12.32	32.22
2035	124.00	141.70	155.56	9.43	13.81	35.41
2036	133.07	152.24	163.76	9.96	14.85	38.38
2037	142.15	161.37	171.97	10.52	14.10	31.21
2038	151.40	170.66	180.41	11.07	15.15	32.69
2039	160.98	179.76	189.03	11.63	16.22	34.19
2040	170.69	189.68	197.78	12.18	18.23	35.44
2041	180.38	199.40	206.69	12.77	19.75	36.81
2042	190.32	209.27	215.69	13.38	21.20	38.22
2043	200.30	219.29	224.96	14.03	22.78	39.34
2044	210.43	229.44	234.40	14.68	23.85	40.52
2045	220.94	239.74	244.09	15.27	24.96	41.68

Table J-65. O'ahu DR Program Grid Service Portfolio (2 of 2)

## J. Modeling Assumptions Data

Demand Response Data

### DR Grid Service Portfolio: Maui

Customer	Commercial		Small Business	
Program	Regulating Reserves	Pricing	Regulating Reserves	Pricing
Grid Service	RegUp	Capacity	RegUp	Capacity
Frequency	Continuous	Daily	Continuous	Daily
Event Length	30 minutes	24 hours	30 minutes	24 hours
Year	MW	MW	MW	MW
2016	–	–	–	–
2017	–	–	–	–
2018	–	0.59	–	1.11
2019	–	1.15	–	1.87
2020	0.01	2.52	0.28	2.58
2021	0.03	2.50	0.35	2.73
2022	0.07	2.51	0.47	2.86
2023	0.11	2.67	0.60	2.93
2024	0.15	2.79	0.69	3.06
2025	0.19	3.11	0.78	3.19
2026	0.23	3.22	0.92	3.35
2027	0.28	3.22	0.99	3.59
2028	0.33	3.29	1.04	3.86
2029	0.38	3.36	1.14	4.08
2030	0.43	3.42	1.20	4.33
2031	0.48	3.49	1.31	4.57
2032	0.53	3.59	1.45	4.81
2033	0.58	3.73	1.57	5.11
2034	0.64	3.86	1.71	5.41
2035	0.69	3.97	1.86	5.69
2036	0.75	4.09	2.00	5.98
2037	0.80	3.74	2.14	5.39
2038	0.86	3.82	2.30	5.62
2039	0.91	3.91	2.50	5.83
2040	0.97	3.98	2.64	6.05
2041	1.02	4.07	2.78	6.27
2042	1.08	4.14	2.94	6.49
2043	1.14	4.22	3.14	6.74
2044	1.19	4.29	3.32	6.97
2045	1.25	4.37	3.49	7.18

Table J-66. Maui DR Program Grid Service Portfolio (1 of 2)

DR Grid Service Portfolio: Maui (2 of 2)

Customer	Residential				
Program	Regulating Reserves	Fast Frequency Response	Pricing	NSAR	CPI
Grid Service	RegUp	FFR	Capacity	Replacement Reserves	Capacity
Frequency	Continuous	Contingency Event	Daily	Contingency	Emergency
Event Length	30 minutes	10 minutes	24 hours	1 hour	4 hours
Year	MW	MW	MW	MW	MW
2016	-	-	-	-	-
2017	-	0.24	0.97	0.24	0.24
2018	0.60	0.60	2.84	0.60	0.60
2019	1.30	1.30	5.09	1.30	1.30
2020	2.10	2.10	8.72	2.10	2.10
2021	2.89	2.57	9.50	2.57	2.57
2022	3.52	2.88	10.34	2.88	2.88
2023	4.58	3.67	11.64	3.67	3.67
2024	6.34	5.01	13.22	5.01	5.01
2025	7.63	6.41	15.01	6.41	6.41
2026	9.09	7.86	16.87	7.86	7.86
2027	10.50	9.37	18.87	9.37	9.37
2028	11.90	10.92	20.86	10.92	10.92
2029	13.29	12.51	21.72	12.51	12.51
2030	15.22	14.15	23.55	14.15	14.15
2031	16.62	15.84	25.47	15.84	15.84
2032	18.64	17.57	27.45	17.57	17.57
2033	20.32	19.34	29.57	19.34	19.34
2034	21.86	21.15	31.77	21.15	21.15
2035	23.97	23.01	33.87	23.01	23.01
2036	25.96	24.90	36.08	24.90	24.90
2037	27.49	26.83	38.38	26.83	26.83
2038	30.06	28.80	40.64	28.80	28.80
2039	32.10	30.81	42.96	30.81	30.81
2040	34.12	32.85	45.23	32.85	32.85
2041	36.15	34.94	47.60	34.94	34.94
2042	37.80	37.06	50.03	37.06	37.06
2043	40.16	39.23	52.35	39.23	39.23
2044	42.15	41.43	54.83	41.43	41.43
2045	44.55	43.67	57.35	43.67	43.67

Table J-67. Maui DR Program Grid Service Portfolio (2 of 2)

## J. Modeling Assumptions Data

Demand Response Data

### DR Grid Service Portfolio: Lana'i

Customer	Commercial		Residential		Small Business	
	Regulating Reserves	Pricing	Regulating Reserves	Pricing	Regulating Reserves	Pricing
Program	RegUp	Capacity	RegUp	Capacity	RegUp	Capacity
Frequency	Continuous	Daily	Continuous	Daily	Continuous	Daily
Event Length	30 minutes	24 hours	30 minutes	24 hours	30 minutes	24 hours
Year	MW	MW	MW	MW	MW	MW
2016	–	–	–	–	–	–
2017	–	–	–	0.02	–	–
2018	0.00	0.02	0.00	0.05	0.00	0.02
2019	0.00	0.03	0.01	0.09	0.00	0.04
2020	0.01	0.05	0.03	0.11	0.01	0.05
2021	0.01	0.06	0.04	0.15	0.01	0.06
2022	0.01	0.07	0.04	0.18	0.01	0.07
2023	0.01	0.08	0.04	0.20	0.01	0.07
2024	0.01	0.08	0.04	0.21	0.01	0.07
2025	0.01	0.09	0.04	0.22	0.01	0.07
2026	0.01	0.09	0.04	0.23	0.01	0.08
2027	0.01	0.09	0.04	0.25	0.01	0.08
2028	0.01	0.09	0.05	0.27	0.01	0.09
2029	0.01	0.10	0.04	0.28	0.01	0.10
2030	0.01	0.10	0.04	0.26	0.01	0.10
2031	0.01	0.10	0.05	0.27	0.01	0.11
2032	0.01	0.10	0.03	0.29	0.01	0.11
2033	0.01	0.10	0.04	0.29	0.01	0.11
2034	0.01	0.11	0.04	0.30	0.01	0.12
2035	0.01	0.11	0.05	0.31	0.01	0.13
2036	0.01	0.11	0.04	0.32	0.01	0.13
2037	0.01	0.11	0.04	0.32	0.01	0.13
2038	0.01	0.10	0.04	0.32	0.01	0.10
2039	0.01	0.10	0.04	0.33	0.01	0.10
2040	0.01	0.10	0.05	0.34	0.01	0.11
2041	0.01	0.10	0.04	0.34	0.01	0.11
2042	0.01	0.10	0.05	0.35	0.01	0.11
2043	0.01	0.10	0.05	0.35	0.01	0.11
2044	0.01	0.10	0.04	0.36	0.01	0.11
2045	0.02	0.10	0.05	0.36	0.01	0.11

Table J-68. Lana'i DR Program Grid Service Portfolio

DR Grid Service Portfolio: Moloka'i

Customer	Commercial		Residential		Small Business	
	Regulating Reserves	Pricing	Regulating Reserves	Pricing	Regulating Reserves	Pricing
Program	RegUp	Capacity	RegUp	Capacity	RegUp	Capacity
Frequency	Continuous	Daily	Continuous	Daily	Continuous	Daily
Event Length	30 minutes	24 hours	30 minutes	24 hours	30 minutes	24 hours
Year	MW	MW	MW	MW	MW	MW
2016	-	-	-	-	-	-
2017	-	-	-	0.02	-	-
2018	0.00	0.01	0.00	0.07	0.00	0.03
2019	0.00	0.02	0.01	0.12	0.01	0.06
2020	0.00	0.04	0.04	0.14	0.01	0.05
2021	0.01	0.05	0.06	0.18	0.02	0.06
2022	0.01	0.05	0.05	0.22	0.02	0.08
2023	0.01	0.05	0.04	0.23	0.02	0.08
2024	0.01	0.05	0.04	0.24	0.02	0.08
2025	0.01	0.06	0.05	0.24	0.02	0.08
2026	0.01	0.06	0.05	0.25	0.02	0.07
2027	0.01	0.06	0.05	0.27	0.02	0.08
2028	0.01	0.06	0.05	0.27	0.02	0.08
2029	0.01	0.06	0.05	0.28	0.02	0.09
2030	0.01	0.07	0.05	0.26	0.02	0.09
2031	0.01	0.07	0.05	0.27	0.02	0.10
2032	0.01	0.07	0.05	0.28	0.02	0.10
2033	0.01	0.07	0.05	0.28	0.02	0.10
2034	0.01	0.07	0.05	0.28	0.02	0.10
2035	0.01	0.07	0.05	0.28	0.02	0.10
2036	0.01	0.07	0.06	0.28	0.02	0.10
2037	0.01	0.07	0.05	0.28	0.02	0.10
2038	0.01	0.06	0.05	0.29	0.02	0.09
2039	0.01	0.06	0.06	0.29	0.02	0.09
2040	0.01	0.06	0.06	0.29	0.02	0.09
2041	0.01	0.06	0.06	0.29	0.02	0.09
2042	0.01	0.06	0.06	0.29	0.02	0.09
2043	0.01	0.06	0.05	0.29	0.02	0.08
2044	0.01	0.06	0.06	0.29	0.02	0.09
2045	0.01	0.06	0.06	0.28	0.02	0.09

Table J-69. Moloka'i DR Program Grid Service Portfolio

## J. Modeling Assumptions Data

Demand Response Data

### DR Grid Service Portfolio: Hawai'i Island

Customer	Commercial		Residential		Small Business	
Program	Regulating Reserves	Pricing	Regulating Reserves	Pricing	Regulating Reserves	Pricing
Grid Service	RegUp	Capacity	RegUp	Capacity	RegUp	Capacity
Frequency	Continuous	Daily	Continuous	Daily	Continuous	Daily
Event Length	30 minutes	24 hours	30 minutes	24 hours	30 minutes	24 hours
Year	MW	MW	MW	MW	MW	MW
2016	–	–	–	–	–	–
2017	–	–	–	1.01	–	–
2018	0.46	0.46	0.69	2.77	0.09	1.02
2019	0.77	0.77	1.46	4.72	0.21	1.70
2020	1.15	1.15	2.43	5.84	0.40	1.66
2021	1.39	1.39	3.35	7.22	0.54	2.02
2022	1.61	1.61	4.39	8.99	0.82	2.56
2023	1.61	1.61	5.87	10.51	1.03	2.76
2024	1.60	1.60	7.63	12.14	1.22	2.96
2025	1.58	1.58	9.24	13.83	1.45	3.18
2026	1.56	1.56	11.01	15.64	1.67	3.43
2027	1.53	1.53	12.71	17.42	1.98	3.69
2028	1.49	1.49	14.70	19.24	2.19	3.93
2029	1.45	1.45	16.58	21.05	2.49	4.17
2030	1.43	1.43	18.74	22.89	2.73	4.43
2031	1.43	1.43	20.69	24.97	3.04	4.74
2032	1.41	1.41	22.75	27.15	3.41	5.05
2033	1.41	1.41	25.15	29.37	3.62	5.37
2034	1.44	1.44	27.52	31.66	3.93	5.70
2035	1.45	1.45	29.75	34.08	4.29	6.05
2036	1.48	1.48	32.01	36.58	4.67	6.40
2037	1.48	1.48	34.60	39.20	5.05	6.80
2038	1.50	1.50	37.06	41.84	5.40	7.19
2039	1.51	1.51	39.85	44.56	5.77	7.58
2040	1.55	1.55	42.20	47.26	6.24	7.98
2041	1.57	1.57	45.30	50.08	6.55	8.39
2042	1.59	1.59	48.12	52.95	6.97	8.79
2043	1.60	1.60	51.02	55.94	7.37	9.24
2044	1.60	1.60	53.75	58.93	7.82	9.70
2045	1.65	1.65	56.76	61.96	8.25	10.14

Table J-70. Hawai'i Island DR Program Grid Service Portfolio

# K. Analytical Steps and Results

## O'AHU ANALYTICAL STEPS AND RESULTS

The core cases analyzed for O'ahu outline different paths to achieving 100% renewable energy in 2045.

### Energy Mix of O'ahu Plans

Figure K-1 summarizes the annual RPS for each year.

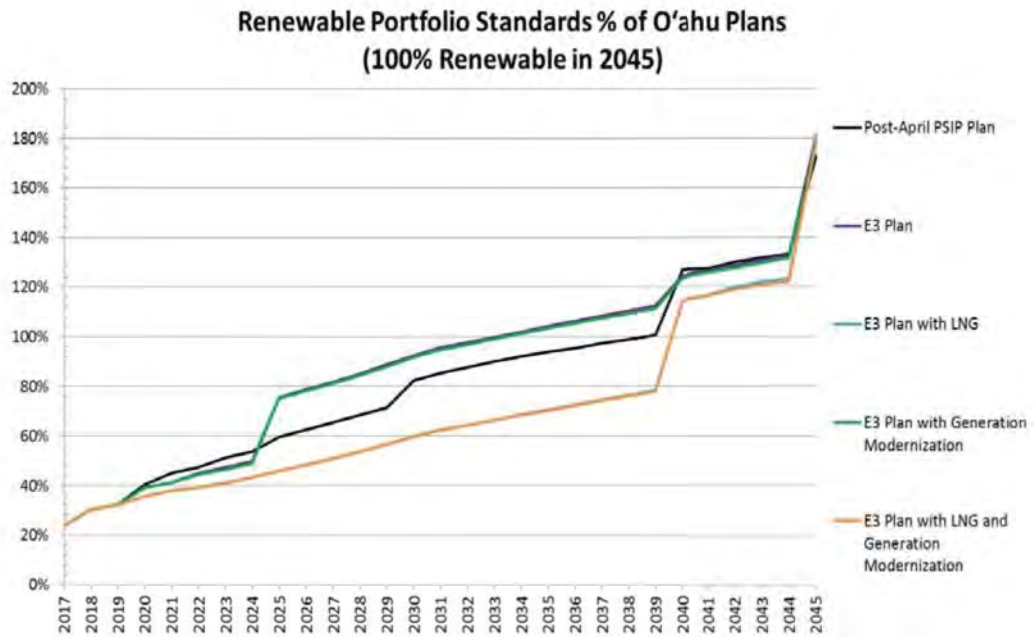

Figure K-1. Renewable Portfolio Standards Percent of O'ahu Plans



## K. Analytical Steps and Results

### O'ahu Analytical Steps and Results

The calculation of the RPS per the law does result in values over 100%. To emphasize that we are committed to achieving 100% renewable energy in 2045, Figure K-2 shows the renewable energy as a percent of total energy including customer-sited generation.

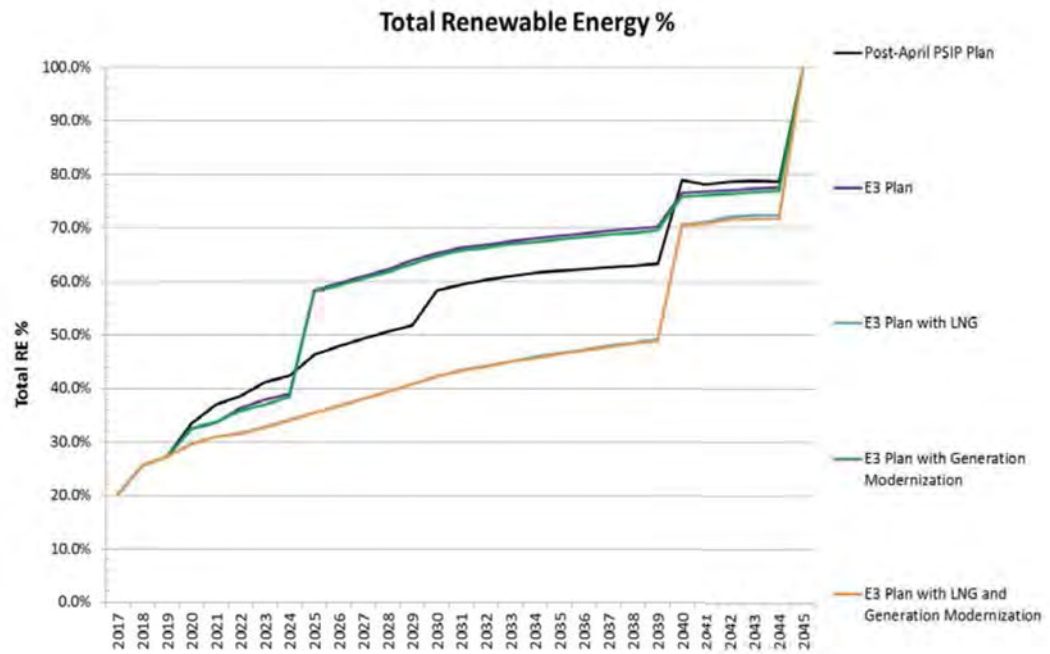

Figure K-2. Total Renewable Energy Percent of O'ahu Plans

The resource mix for the plans changes over time as it reaches 100% renewable in 2045. The figures below reveal how the energy mix in each plan grows to 100% renewable energy.

The annual energy served by resource type is shown in Figure K-3 for the Post-April PSIP Plan. The transition to renewable wind and solar can be easily seen as the fossil fuel (oil and coal) significantly decreases over time.

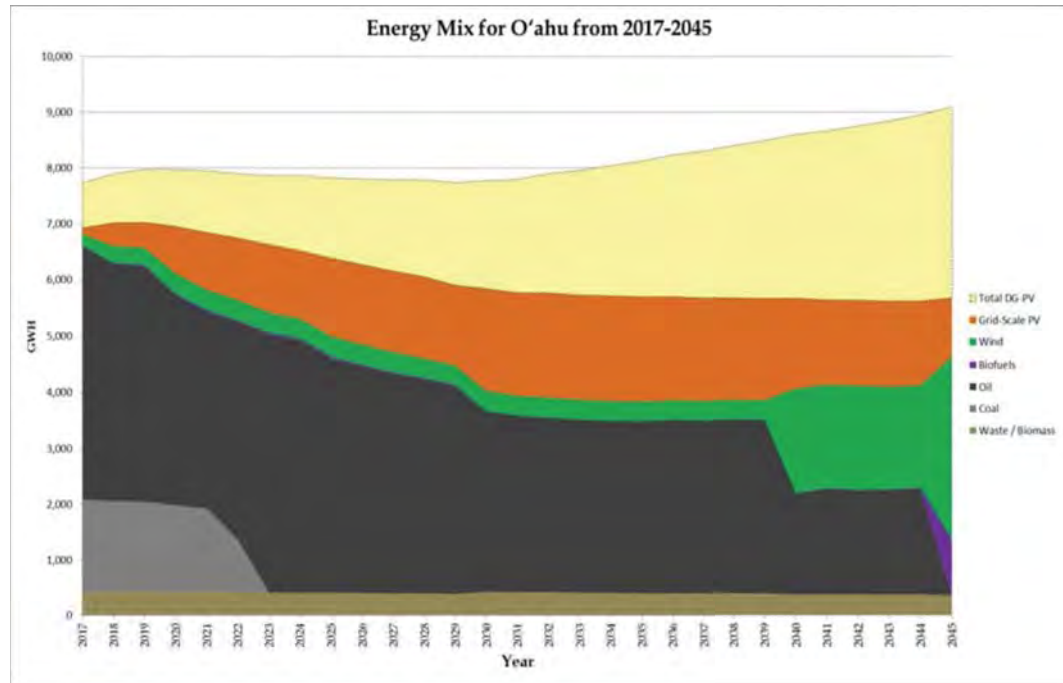

Figure K-3. Energy Mix for Post-April PSIP Plan on O'ahu

Figure K-4 shows the energy mix of the E3 Plan without LNG.

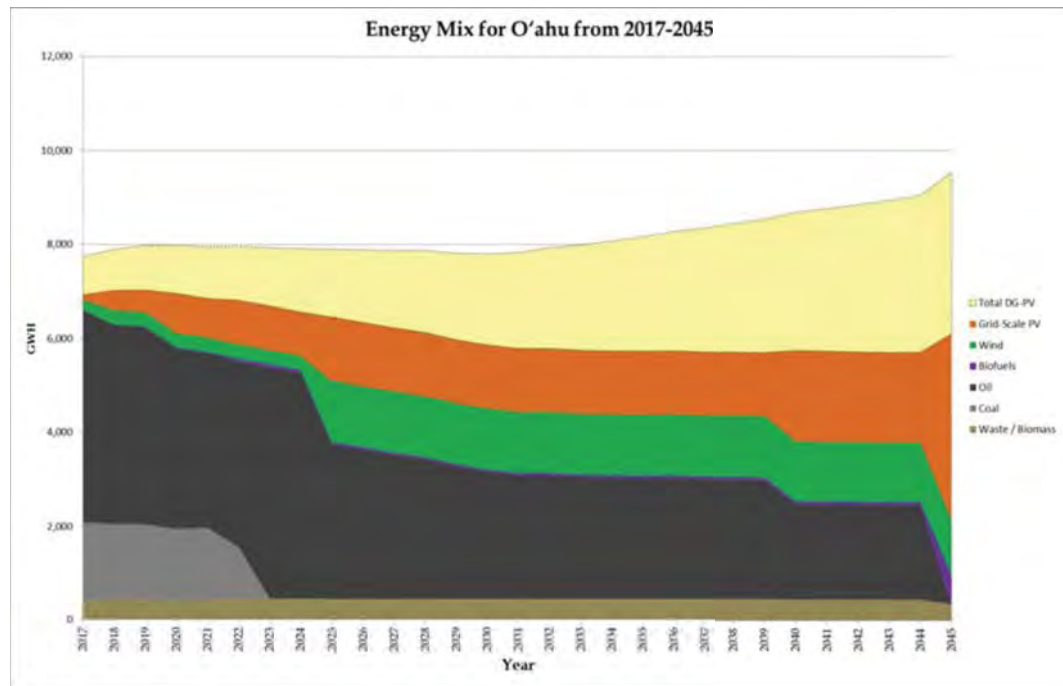

Figure K-4. Energy Mix for E3 Plan on O'ahu

The E3 Plan with LNG uses LNG as a transitional fuel from oil. Renewable energy is added economically to meet intermediate RPS targets and ultimately 100% renewable energy in 2045. The energy mix for E3 Plan with LNG is shown in Figure K-5. The

## K. Analytical Steps and Results

### O'ahu Analytical Steps and Results

transition to LNG assumes a contract period of 2022–2041. During the last intervening years in the transition to 100% renewable energy, potential future resources at this time could include biofuels, LNG, oil, other renewable options or a mix of options. Given rapidly evolving energy options and technology, the exact fuel mix is difficult to predict today.

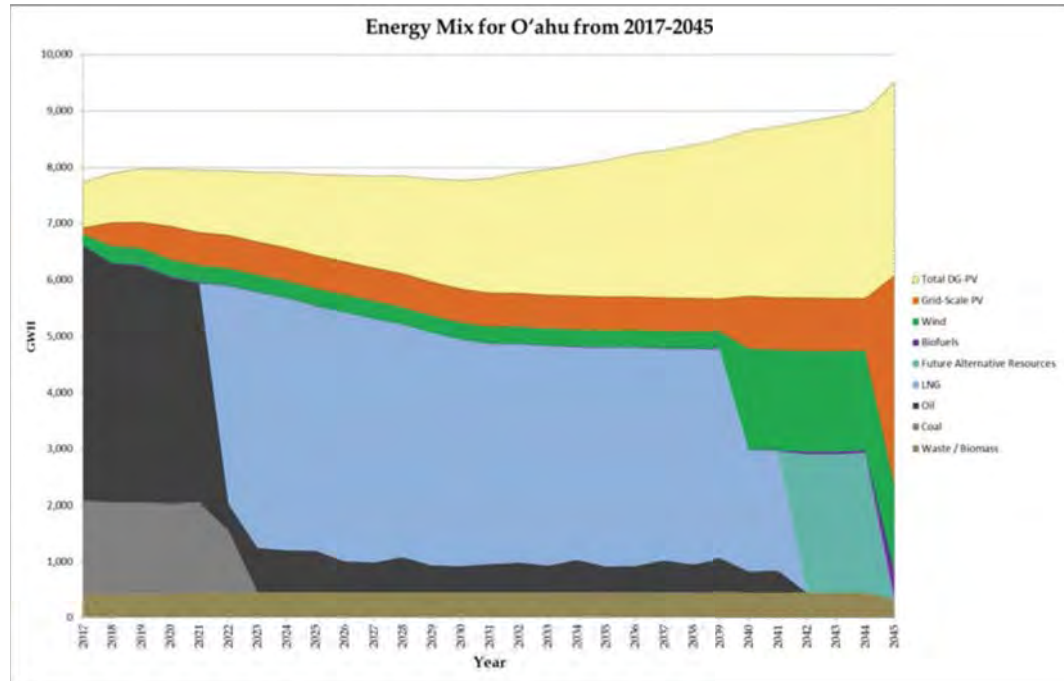

Figure K-5. Energy Mix for E3 Plan with LNG on O'ahu

Including generation modernization did not noticeably change the E3 Plan without LNG as shown in Figure K-6.

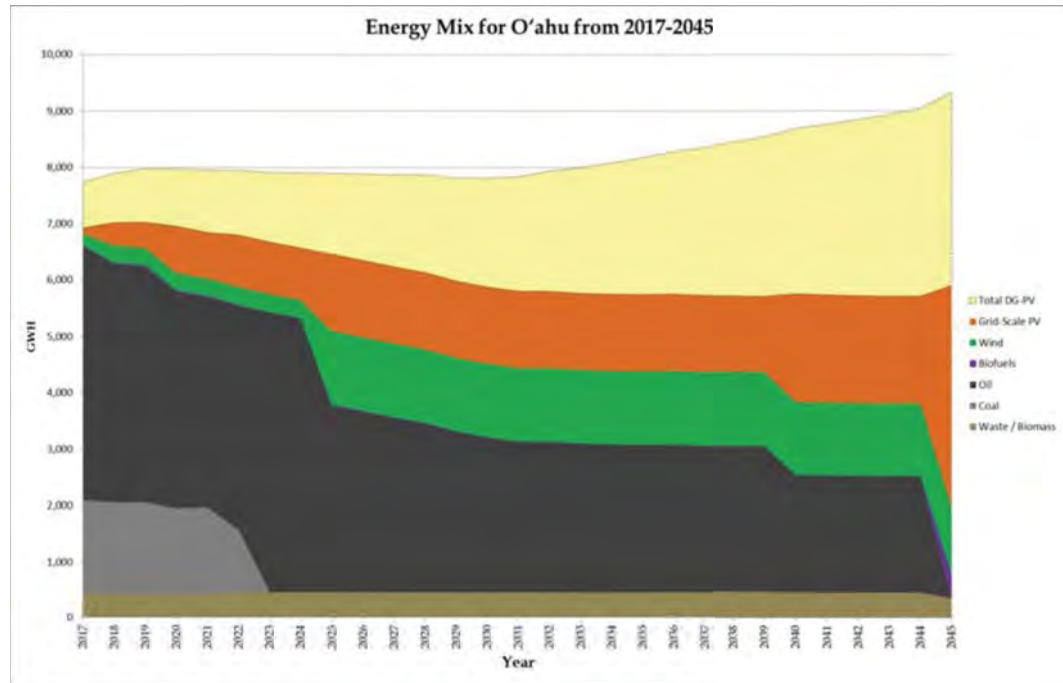

Figure K-6. Energy Mix for E3 Plan with Generation Modernization on O'ahu

Similarly, including generation modernization did not noticeably change the E3 Plan with LNG as shown in Figure K-7 below. Again, the transition to LNG assumes a contract period of 2022-2041. During the last intervening years in the transition to 100% renewable energy, potential future resources at this time could include biofuels, LNG, oil, other renewable options or a mix of options. Given rapidly evolving energy options and technology, the exact fuel mix is difficult to predict today.

## K. Analytical Steps and Results

### O'ahu Analytical Steps and Results

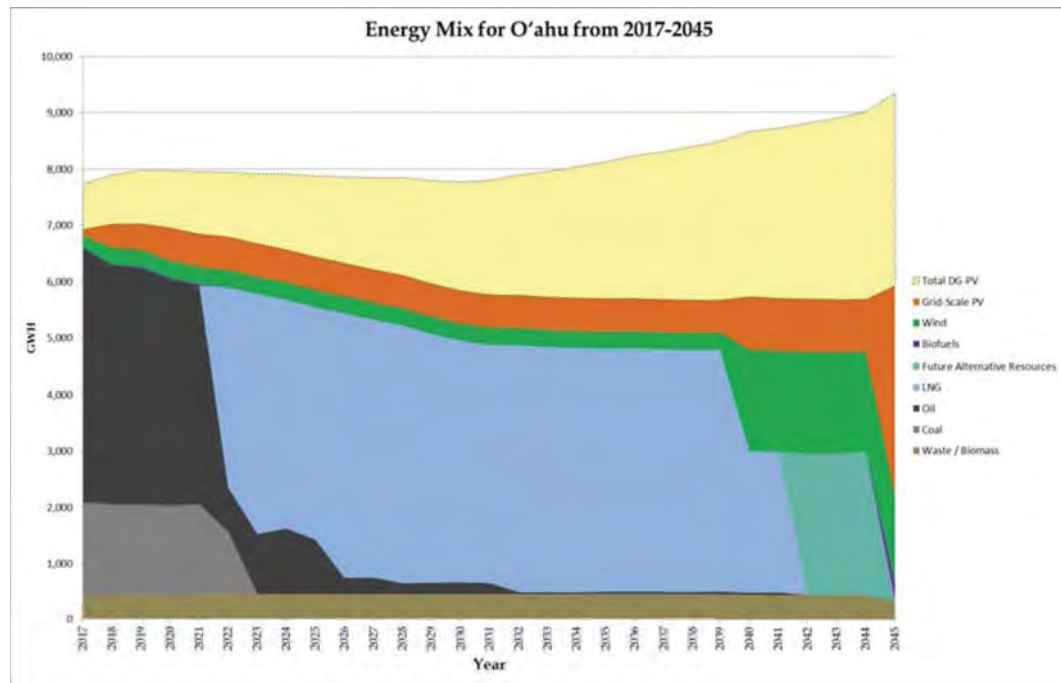

Figure K-7. Energy Mix for E3 Plan with LNG and Generation Modernization

### Percent Over-Generation of Total System for O'ahu Plans

Hawaiian Electric has been actively increasing the flexibility of the existing generating units to integrate increasing levels of variable generation. All the core cases analyzed include the capability to operate existing generating units at lower minimum load levels, minimizing baseload operation of the existing generators, and adding new firm flexible generation along with increasing wind and solar generation. Even with more flexible firm generating units, there may still be instances of over-generation of variable resources during low demand periods (which may occur during daytime hours due to influence of DG-PV, as well as during typical night time low load hours).

As increasingly more renewable energy is added to the system, over-generation occurrences will become inevitable. Figure K-8 provides estimates of the percent over-generation of the total system annual energy for the various plans. Since the Post-April PSIP Plan integrates greater amounts of grid-scale PV than the E3 plans in the earlier years, the percent over-generation is higher in these years in the Post-April PSIP Plan. The E3 plans add greater amounts of storage much earlier than the Post-April PSIP Plan which helps to reduce over-generation. Situations of over-generation, however, provide opportunities to allow wind and solar generation to contribute to regulation up resources in addition to use as a reserve resource, if they are coupled with appropriate control systems. This provides improved system performance. In combination, wind and solar used for energy and some level of regulation and reserve appears to be cheaper than the

alternative of additional storage, at least at moderate over-generation levels. For the purposes of this December 2016 PSIP update (similar to the April 2016 PSIP update), we include the full cost of the grid-scale wind and grid-scale PV resources in cost calculations, regardless of over-generation levels and provide a simplified accounting for other services from these resources.

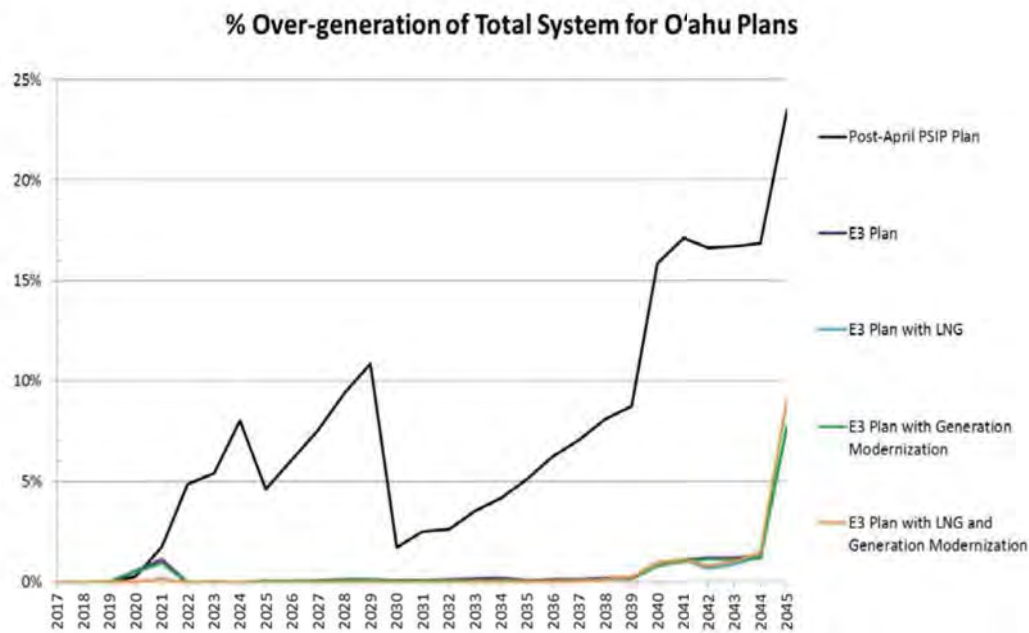

Figure K-8. Total System Over-Generation Percent for O'ahu Plans

### Unserviced Energy of O'ahu Plans

While periods of over-supply exist as described above, periods of unserved energy can also occur. The plans evaluate whether sufficient generation to serve load exists with variable renewable energy and storage with minimal conventional thermal resources on the system. The E3 plans identified existing conventional thermal generating units that could be considered for removal from service as an economic option. For the PLEXOS modeling of the E3 plans, these units were made unavailable to serve load or “offline”. If there was sufficient generation provided by the remaining thermal resources, variable renewable resources, and storage, then there would not be any unserved energy. The year-by-year amount of unserved energy in hours and energy for the E3 Plan is shown in Figure K-9. There are some years that have significant amounts of unserved energy. For example, in 2022, there are approximately 2,000 MWh total of unserved energy that occurs over the course of 36 hours in that year.

## K. Analytical Steps and Results

### O'ahu Analytical Steps and Results

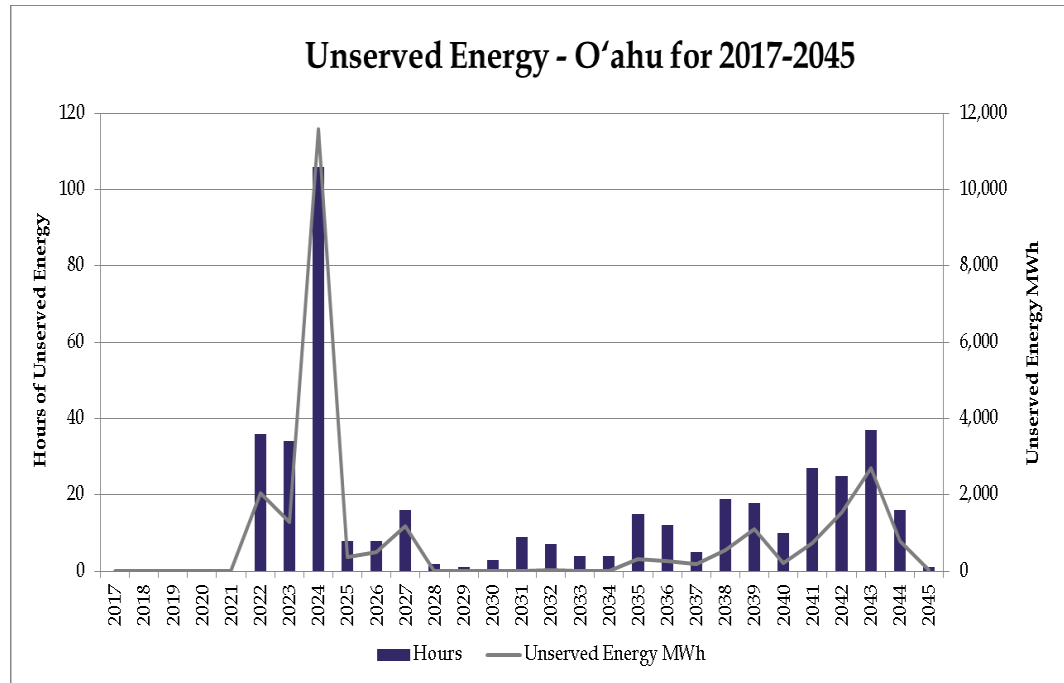

Figure K-9. Unserved Energy for E3 Plan on O'ahu

As shown in Figure K-10, the E3 Plan with Generation Modernization significantly reduces the amount of unserved energy. For example, in 2022, there is about 0.56 MWh of unserved energy which occurs over about 6 hours in the year.

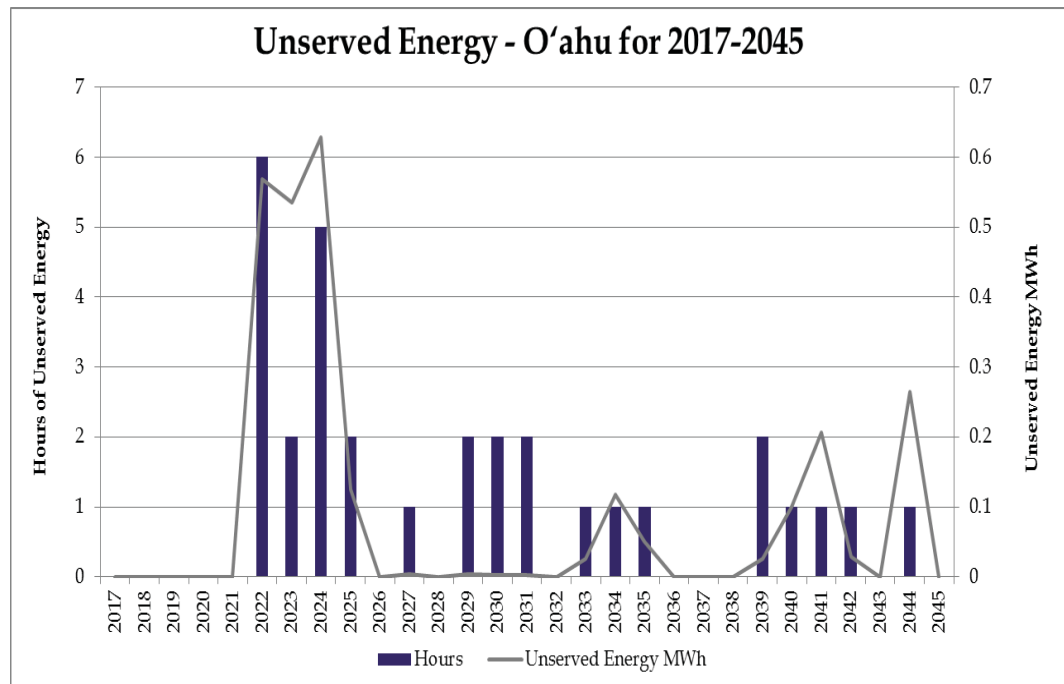

Figure K-10. Unserved Energy for E3 Plan with Generation Modernization on O'ahu

The Post-April PSIP Plan gradually incorporates generation modernization with the deactivation of existing thermal resources. Figure K-11 indicates that the Post-April PSIP Plan does not have unserved energy until about 2030 and does not have more than 5 hours of unserved energy in any given year through 2045. The few hours of unserved energy could be investigated in more detail and may be due to thermal generating units being on maintenance which could be adjusted or refined as we approach the year of concern.

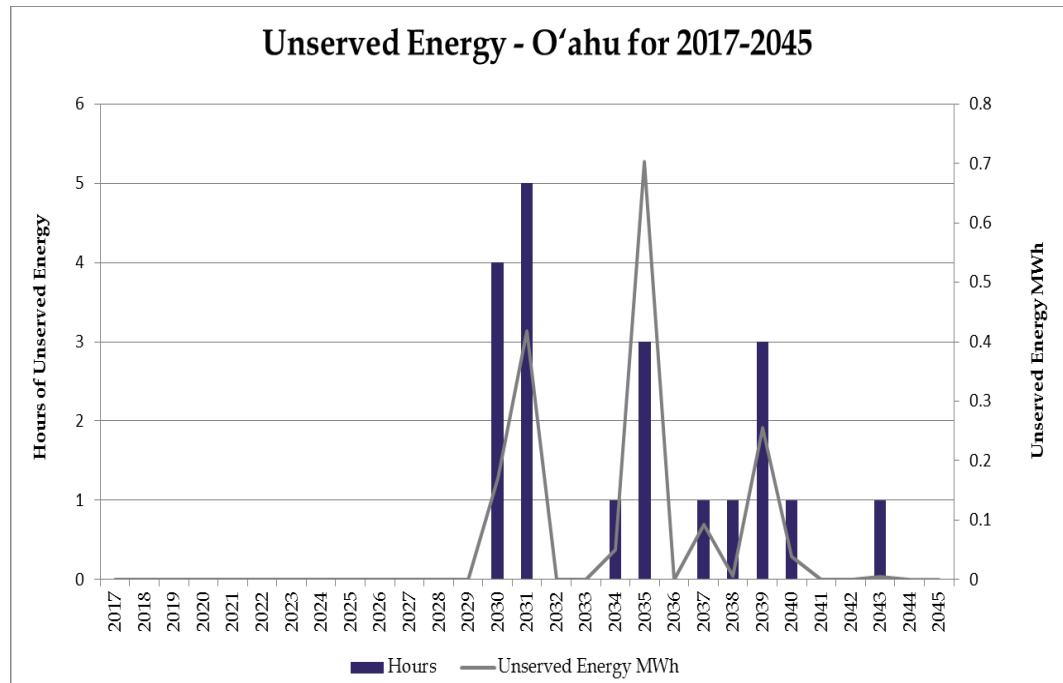

Figure K-11. Unserved Energy for Post-April PSIP Plan on O'ahu

### Seasonal Variations of O'ahu Renewable Energy

With limited firm renewable resources available on-island on O'ahu, the majority of renewable energy will be supplied from either variable, intermittent generation or biofuelled thermal generation. The figures below illustrate the impact of seasonal variations in variable renewable generation such as wind and solar.

Figure K-12 shows the difference between the load and the available renewable energy in the year 2025 for the E3 Plan. To prevent unserved energy, this difference must be served with thermal generation.



## K. Analytical Steps and Results

### O'ahu Analytical Steps and Results

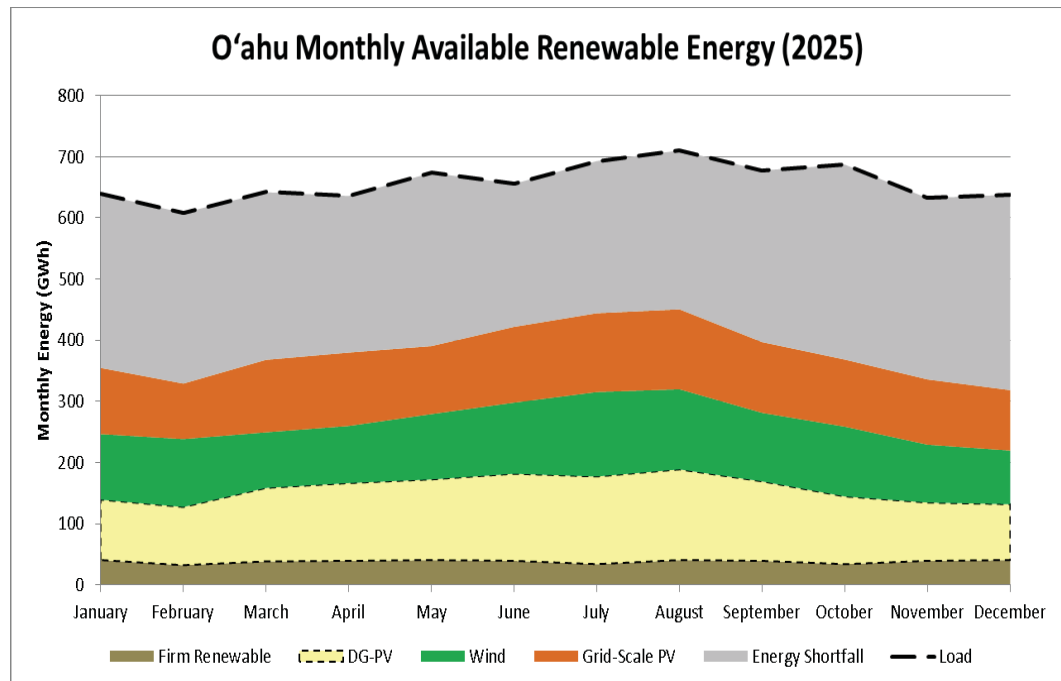

Figure K-12. E3 Plan Monthly Available Renewable Energy vs Load on O'ahu in 2025

Figure K-13 shows the difference between the load and the available renewable energy in the year 2045 for the E3 Plan. In 2045, in the E3 Plan, there is approximately 2,100 MW of DG-PV, over 2,000 MW of grid-scale PV, 200 MW of offshore wind, 68 MW of waste to energy, and 160 MW of onshore wind. Despite these high amounts of renewables on the system, there are some months where there is a deficit of renewable energy available, shown in gray, to serve the load. However, there are also months for which there is a surplus, shown in pink. This highlights the continued need for thermal generators to provide supplemental generation during these shortfall periods or energy storage systems, which are capable of shifting energy over several months from the months where there is a surplus to the months where there are shortfalls.

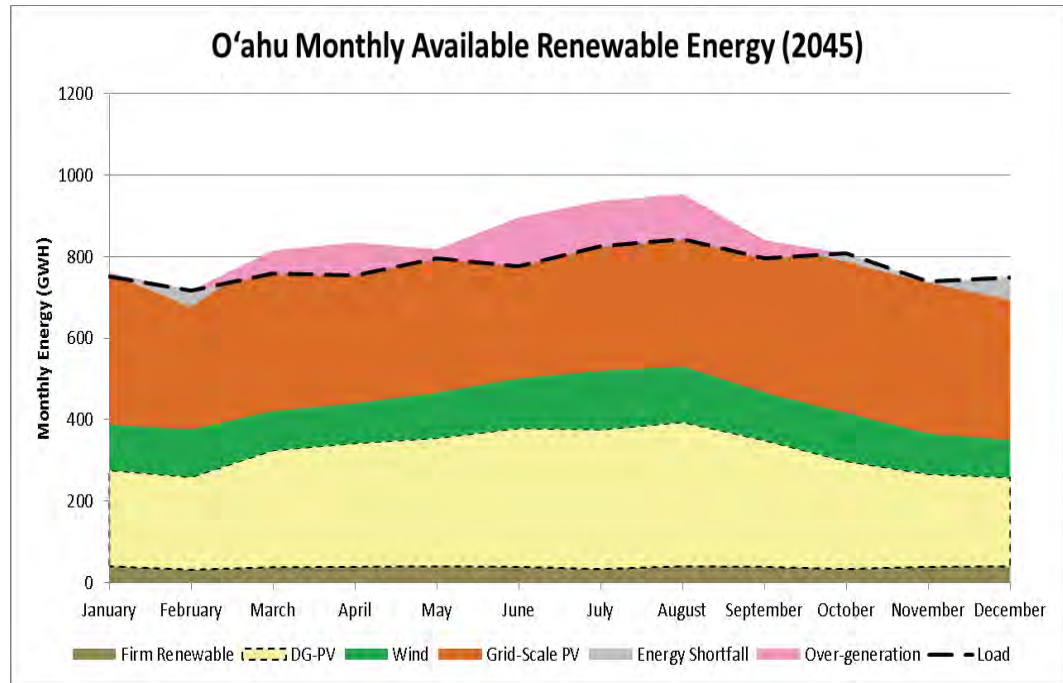

Figure K-13. E3 Plan Monthly Available Renewable Energy vs Load on O'ahu in 2045

### Sub-Hourly Charts of O'ahu Plans

Sub-hourly modeling was performed to analyze the impact that variable renewable energy would have on our system, and whether our portfolio of generators and storage systems would be sufficient to stabilize the electrical grid.

Historical minutely renewable energy data was used to determine the volatility of solar and wind resources on O'ahu. The volatility of the Kahuku wind farm was applied to future grid-scale wind resources, and the volatility of the Kalaeloa Renewable Energy Park (KREP) PV project was applied to future grid-scale PV resources.

An initial screening was done to determine the month with the largest potential minutely downward ramp. PLEXOS was then employed to perform a stochastic analysis on this month. Using the historical minutely data, stochastic variables were created for all as-available resources and the load. Shown below are the results from the sub-hourly analysis of the E3 Plan when a 1-, 15-, and 30-minute look-ahead is assumed.

Figure K-14 shows the estimated unserved energy at a 1 minute look-ahead for the E3 plan.

## K. Analytical Steps and Results

### O'ahu Analytical Steps and Results

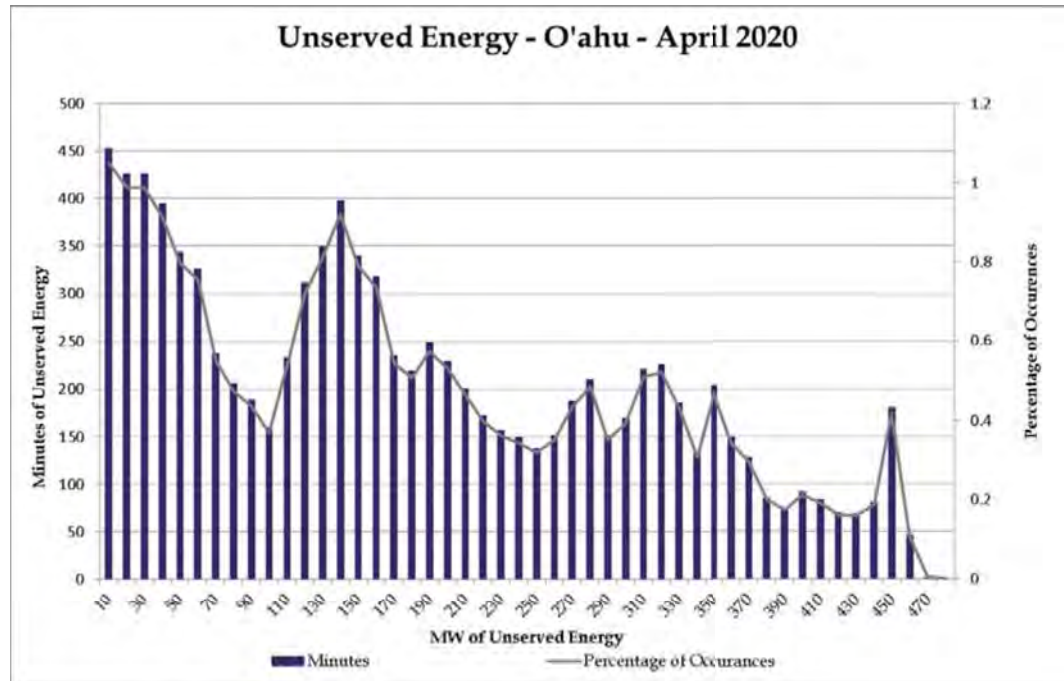

Figure K-14. Sub-Hourly Unserviced Energy for E3 Plan on O'ahu at 1-Minute Look-Ahead

Figure K-15 shows the estimated unserved energy at a 1-minute look-ahead for the Post-April PSIP plan. Comparing Figure K-14 from the E3 Plan which does not include a regulating battery to Figure K-15, from the Post-April PSIP Plan, which includes a 100 MW regulating battery in 2020, both the number of occurrences as well as the magnitude of the event decreases.

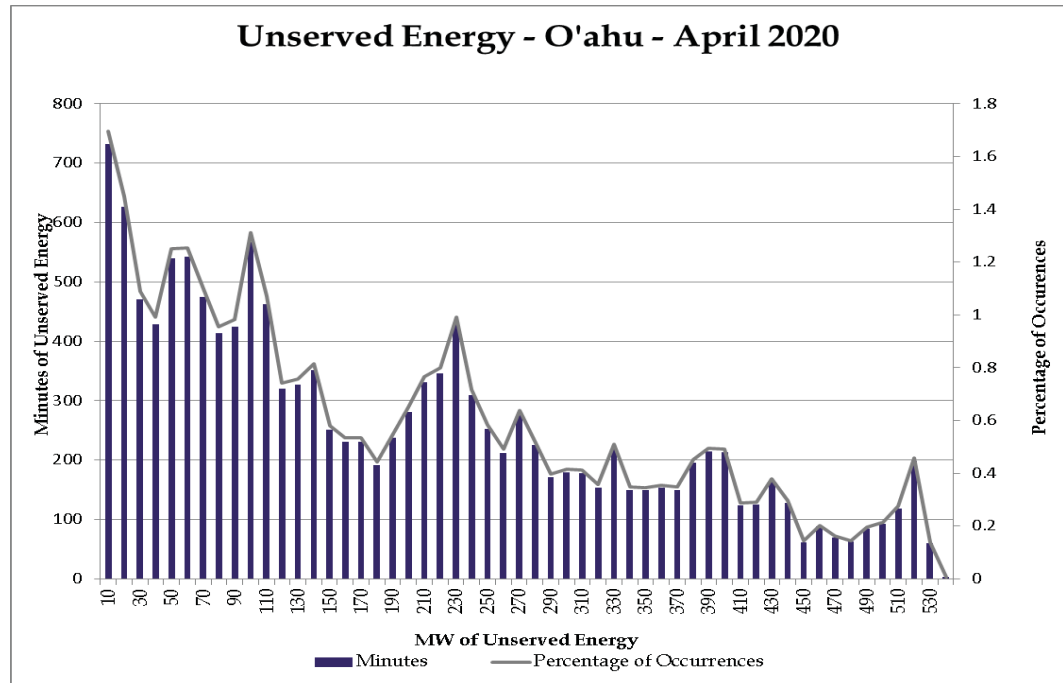

Figure K-15. Sub-Hourly Unserved Energy for the Post-April PSIP Plan on O'ahu at 1-Minute Look-Ahead

Figure K-16 shows the estimated unserved energy with a 15 minute look-ahead for the E3 plan. As shown, the unserved energy magnitude and number of occurrences significantly decreases with 15 minute look-ahead.

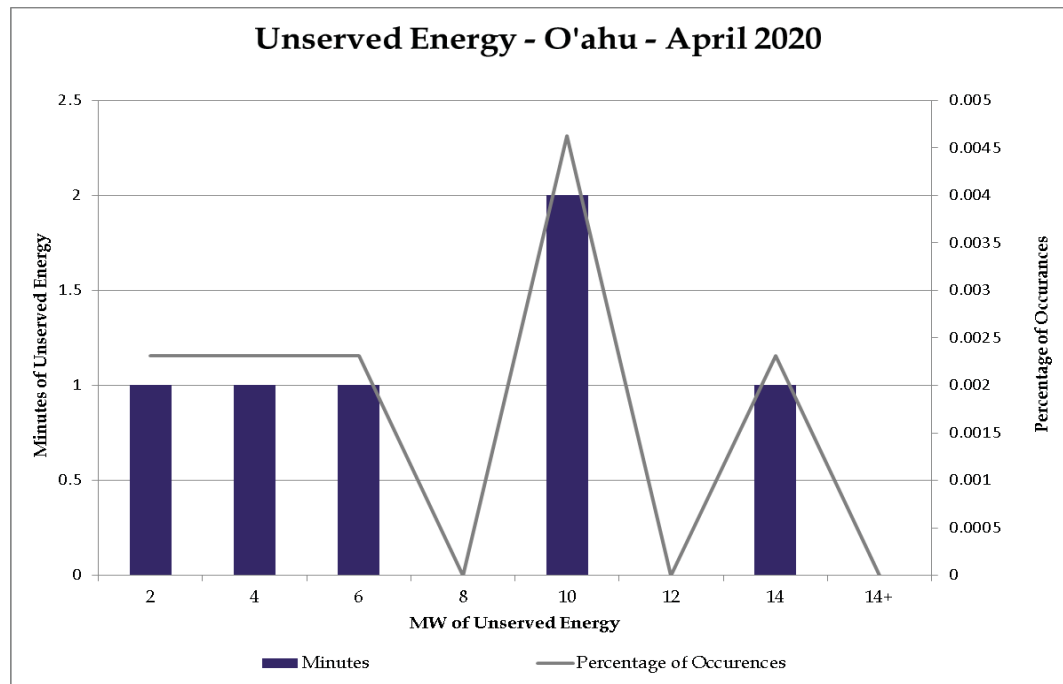

Figure K-16. Sub-Hourly Unserved Energy for E3 Plan on O'ahu at 15-Minute Look-Ahead

## K. Analytical Steps and Results

### O'ahu Analytical Steps and Results

Figure K-17 shows the estimated unserved energy with a 15 minute look-ahead for the Post-April plan.

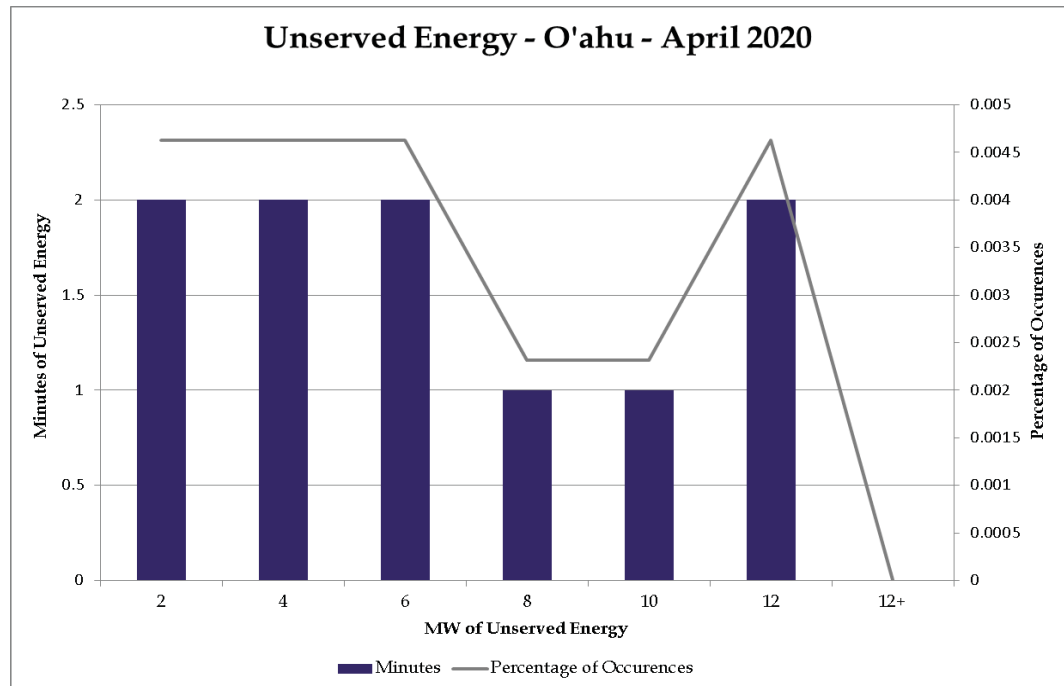

Figure K-17. Sub-Hourly Unserved Energy for the Post-April PSIP Plan on O'ahu at 15-Minute Look-Ahead

With a 30 minute look-ahead setting, there is virtually no unserved energy.

## Daily Energy Charts of O'ahu Plans

The charts in the previous sections displayed annual and monthly views of how renewable energy is integrated into the plans and the impacts to the system energy production. This section will convey a more granular view by illustrating the energy mix for select days of some years of the plans that were modeled.

### High Over-Generation Energy Profiles for E3 Plan with Generation Modernization

Figure K-18 provides a view of the day in the year 2020 that has the highest amount of over-generation for the E3 Plan with Generation Modernization.

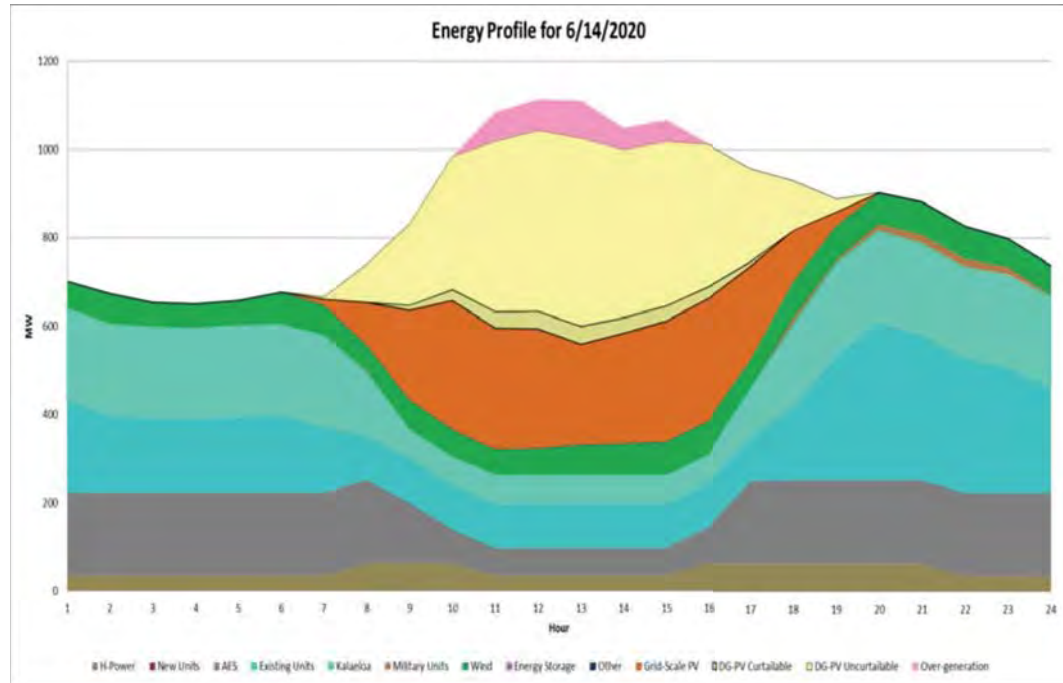

Figure K-18. E3 Plan with Generation Modernization O'ahu High Over-Generation Energy Profile: 2020

The day in 2030 that has the highest amount of over-generation for the E3 Plan with Generation Modernization is shown in Figure K-19. It can be seen that during the middle of the day, almost all of the load is being served by renewable energy and that the storage is being charged during that time. The energy storage is then dispatched in the evening.

## K. Analytical Steps and Results

### O'ahu Analytical Steps and Results

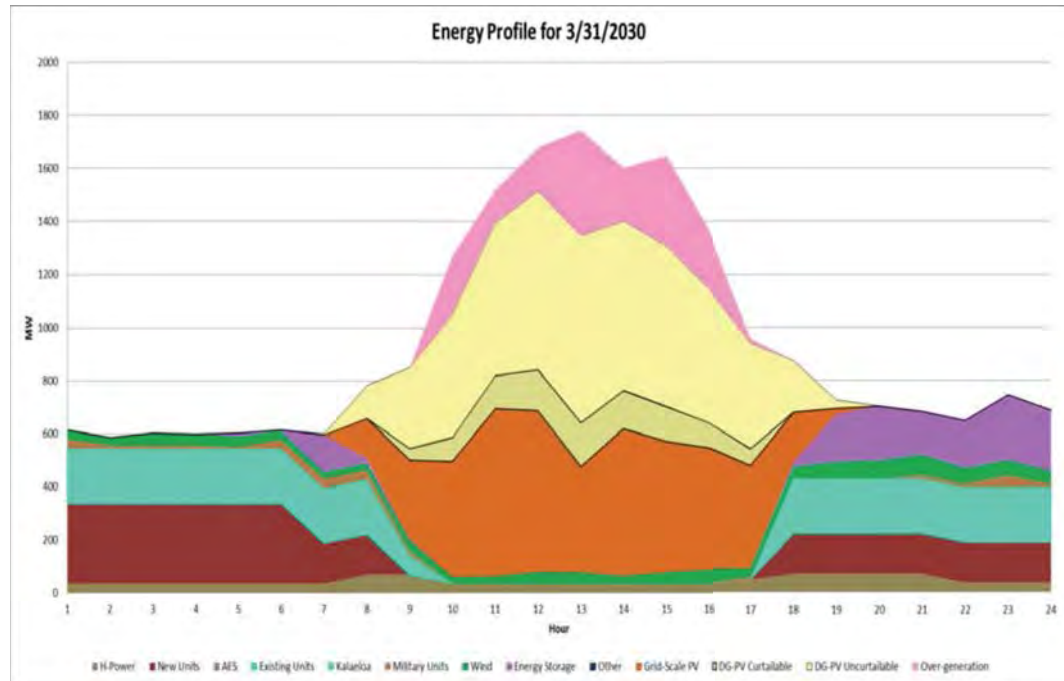

Figure K-19. E3 Plan with Generation Modernization O'ahu High Over-Generation Energy Profile: 2030

Figure K-20 shows that there is more over-generation in 2040, and by 2045, there is over-generation occurring for many hours shown in Figure K-21.

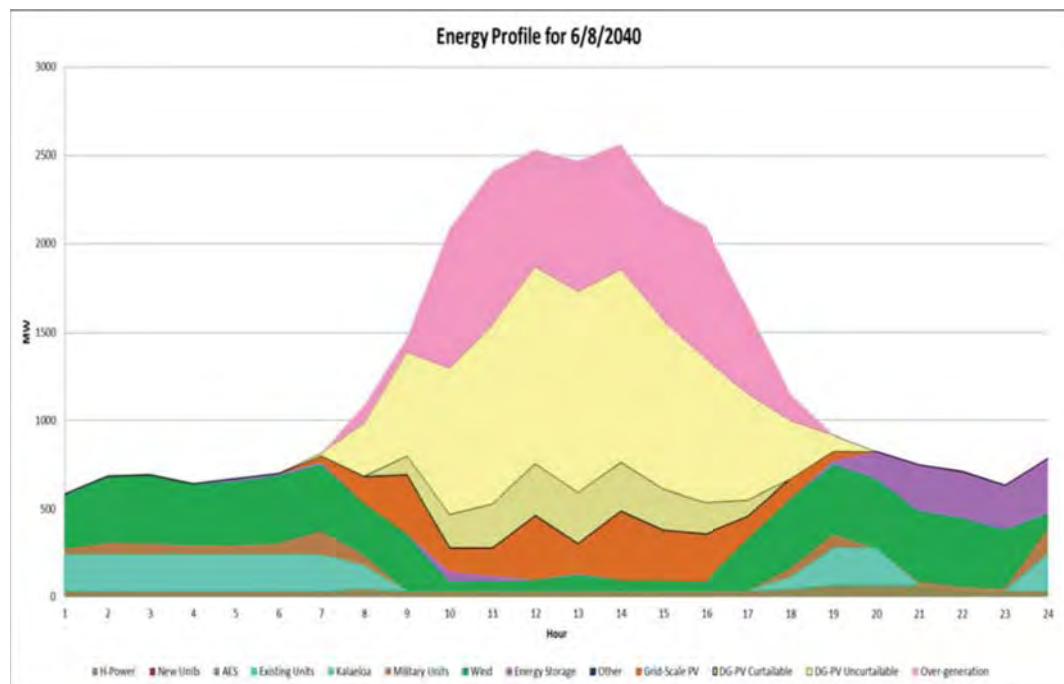

Figure K-20. E3 Plan with Generation Modernization O'ahu High Over-Generation Energy Profile: 2040

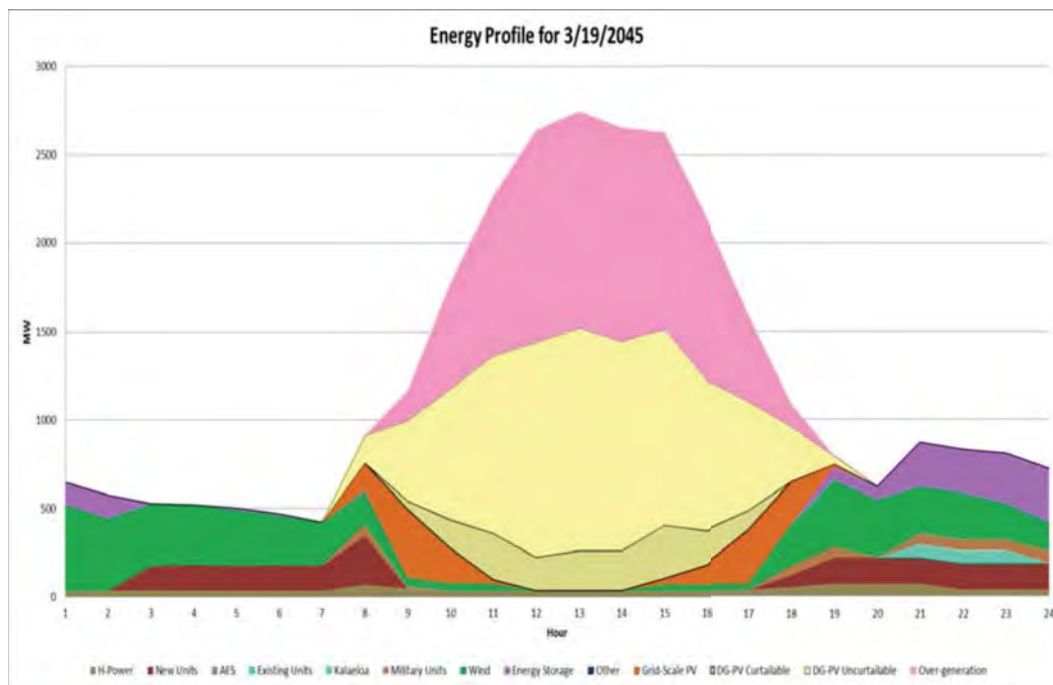

Figure K-21. E3 Plan with Generation Modernization O'ahu High Over-Generation Energy Profile: 2045

### Low Renewable Energy Profiles for E3 Plan with Generation Modernization

Although Hawai'i has abundant renewable resources, such as wind and solar, there are days for which there is limited solar and/or limited or no wind available. Figure K-22, Figure K-23, Figure K-24, and Figure K-25 illustrate how different the energy profile is on days with low renewable energy available in the years 2020, 2030, 2040, and 2045, respectively, for the E3 Plan with Generation Modernization. Even in later years, such as 2040 and 2045, where there are significant amounts of renewable resources and energy storage included in the plan, on these low renewable days, thermal generation is still necessary to serve the load.



## K. Analytical Steps and Results

### O'ahu Analytical Steps and Results

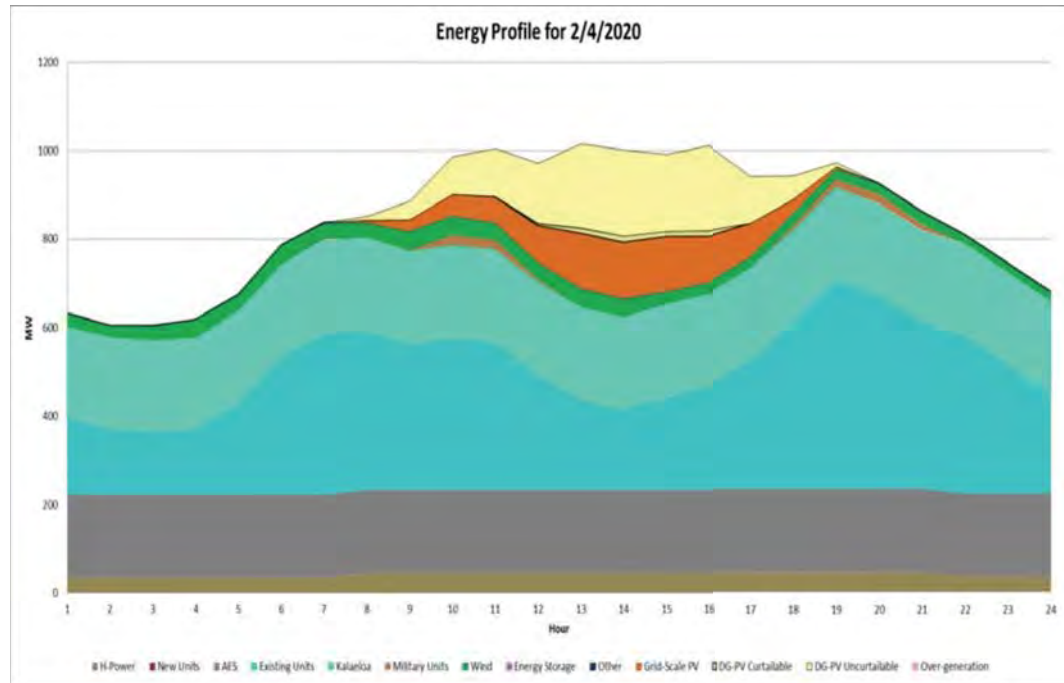

Figure K-22. E3 Plan with Generation Modernization O'ahu Low Renewables Energy Profile: 2020

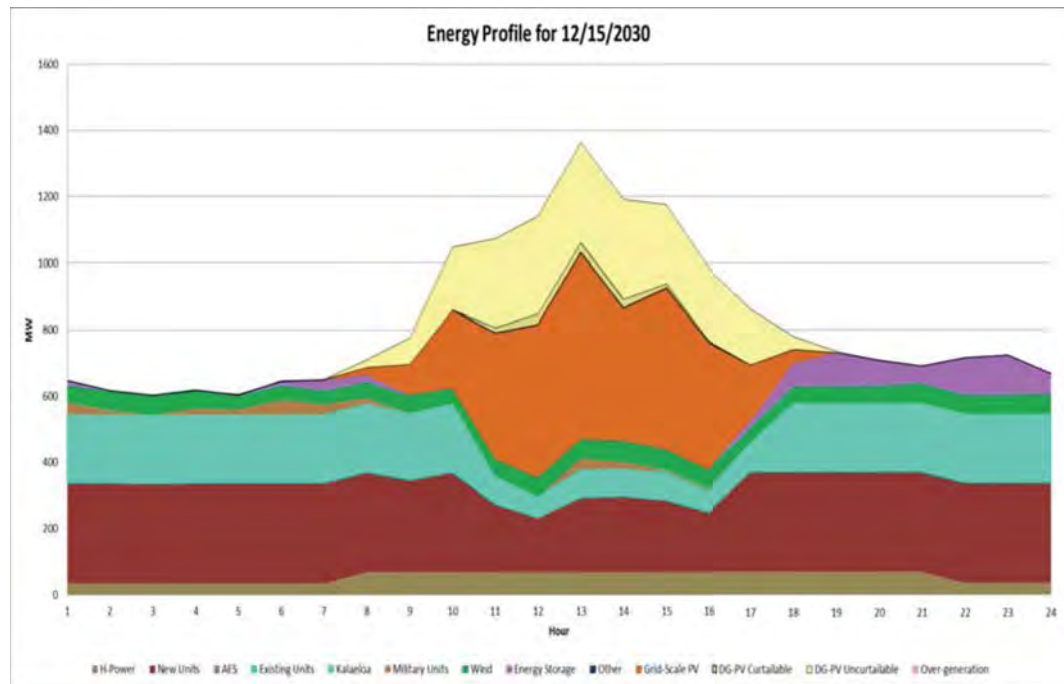

Figure K-23. E3 Plan with Generation Modernization O'ahu Low Renewables Energy Profile: 2030

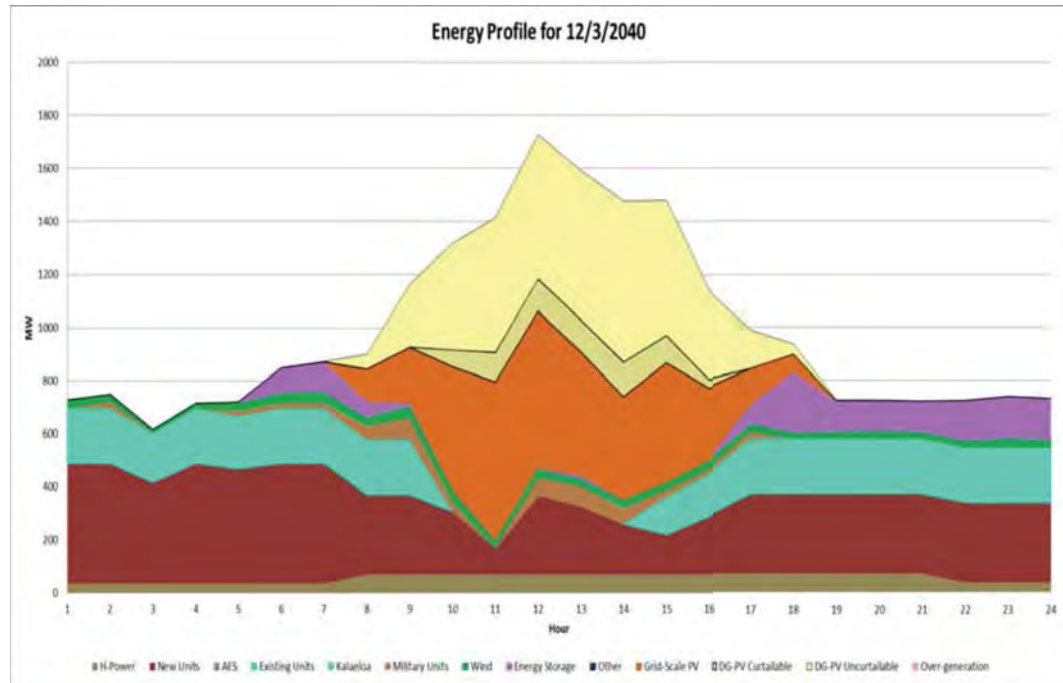

Figure K-24. E3 Plan with Generation Modernization O'ahu Low Renewables Energy Profile: 2040

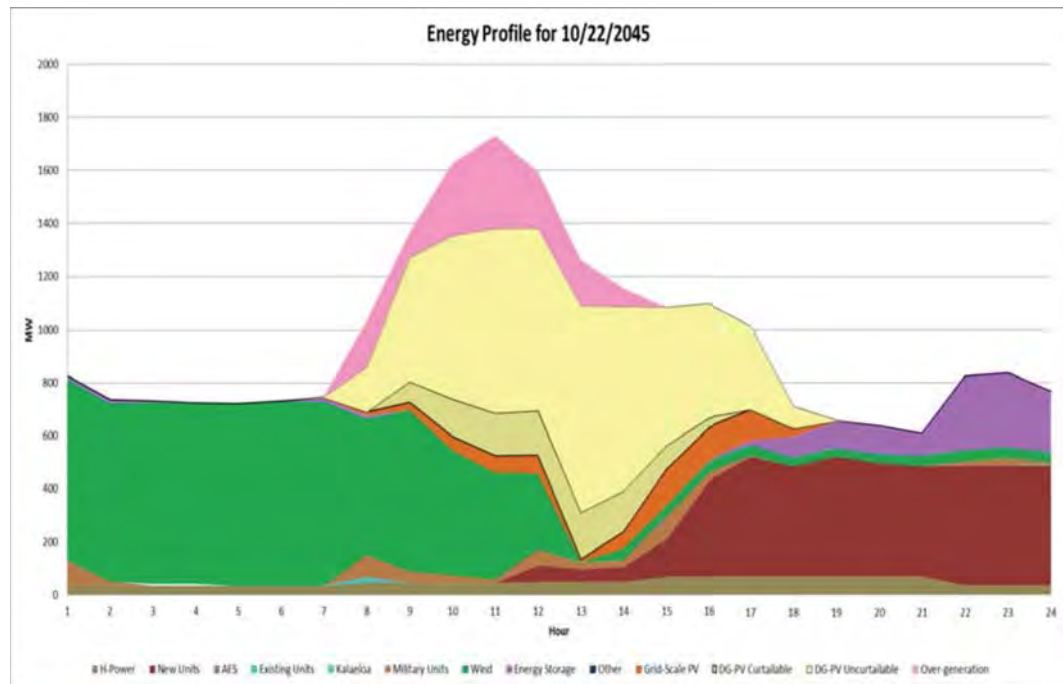

Figure K-25. E3 Plan with Generation Modernization O'ahu Low Renewables Energy Profile: 2045

## K. Analytical Steps and Results

### O'ahu Analytical Steps and Results

#### High Over-Generation Energy Profiles for Post-April PSIP Plan

Since the Post-April PSIP Plan has a different resource mix than the E3 plans, the daily energy profiles for the same years (2020, 2030, 2040, and 2045) are provided below.

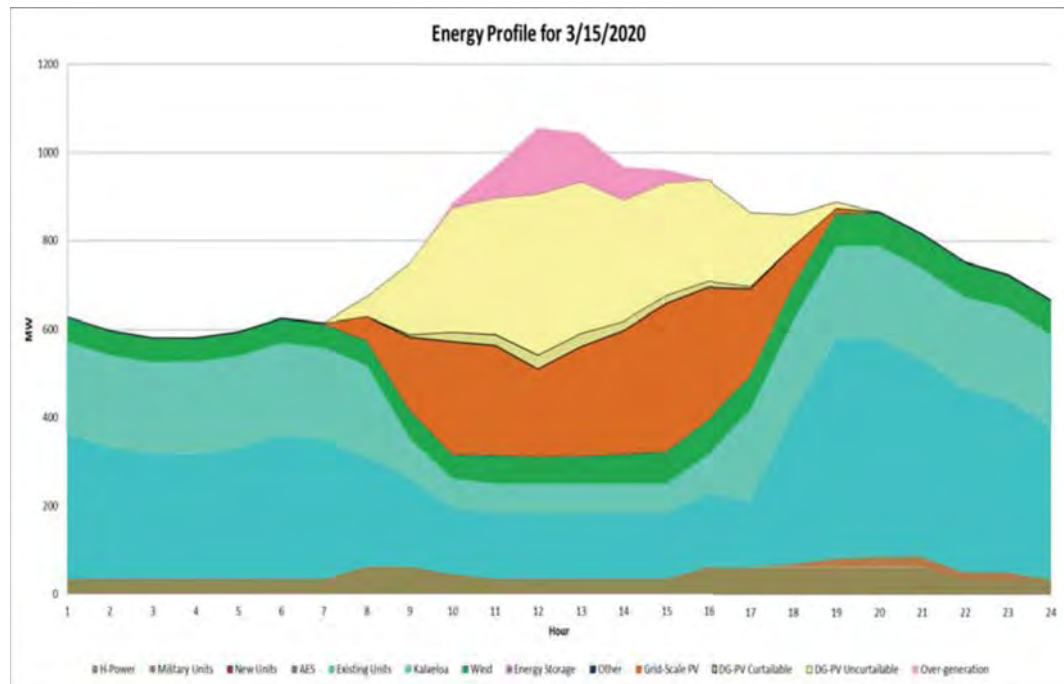

Figure K-26. Post-April PSIP Plan O'ahu High Over-Generation Energy Profile: 2020

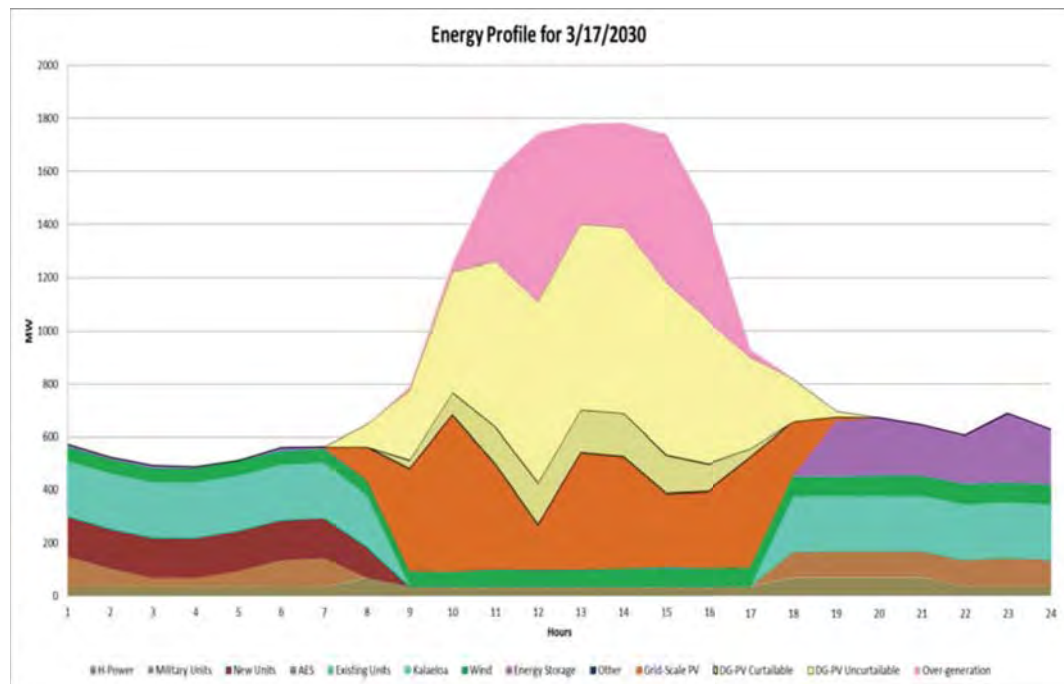

Figure 4-27. Post-April PSIP Plan O'ahu High Over-Generation Energy Profile: 2030

## K. Analytical Steps and Results

### O'ahu Analytical Steps and Results

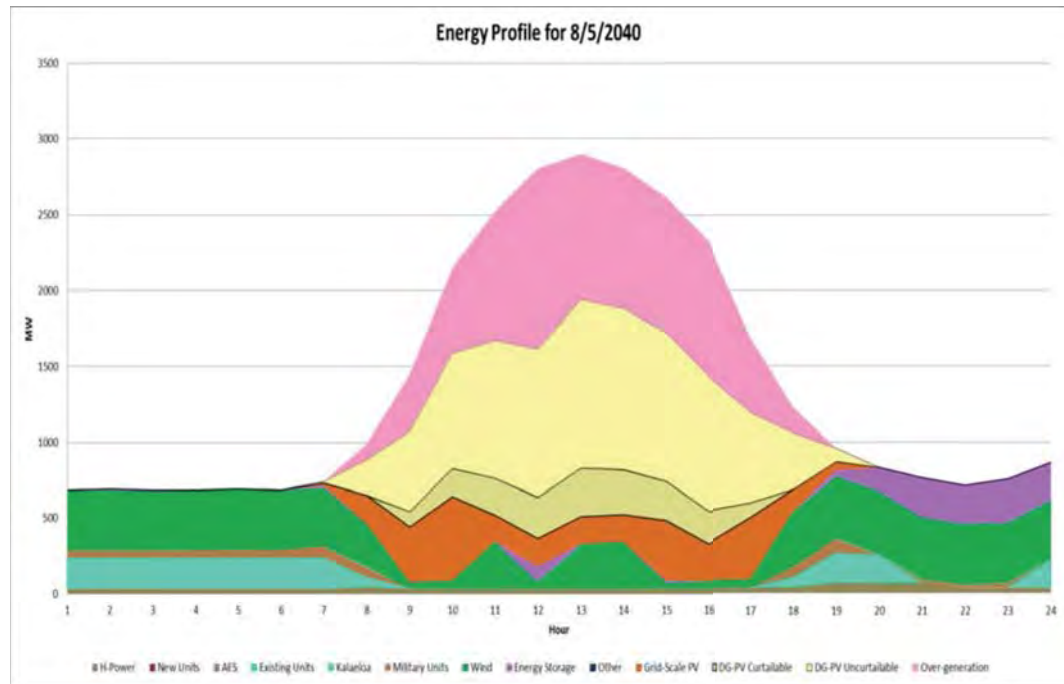

Figure K-28. Post-April PSIP Plan O'ahu High Over-Generation Energy Profile: 2040

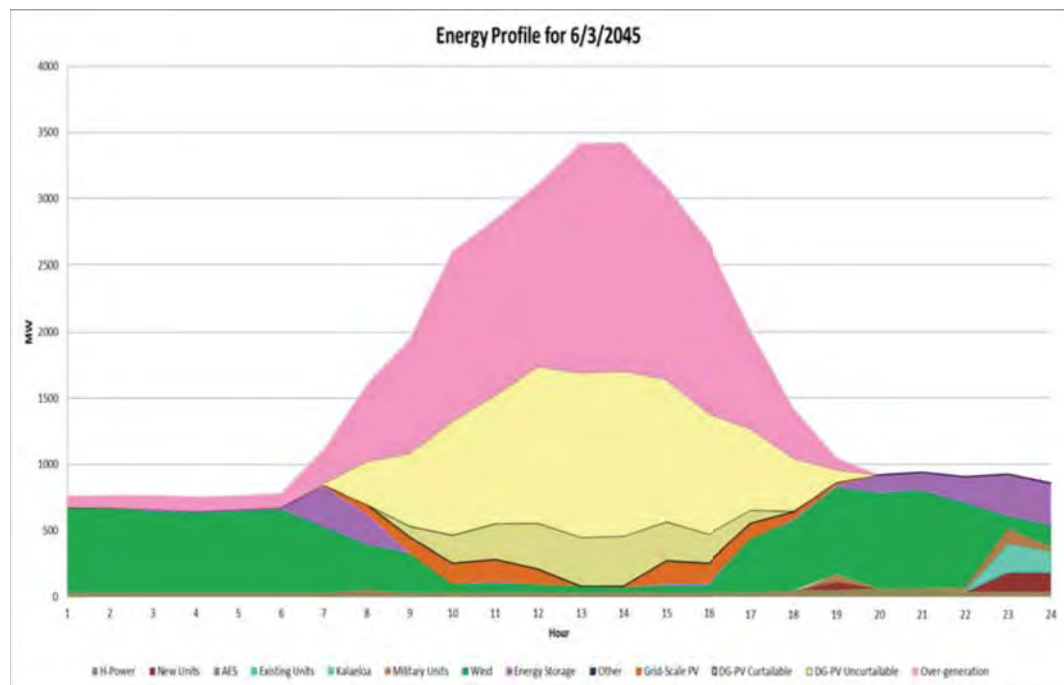

Figure K-29. Post-April PSIP Plan O'ahu High Over-Generation Energy Profile: 2045

## K. Analytical Steps and Results

### O'ahu Analytical Steps and Results

#### Low Renewable Energy Profiles for Post-April PSIP Plan

The daily energy profiles for the same years (2020, 2030, 2040, and 2045) for the Post-April PSIP Plan are provided below as a comparison to the E3 plans.

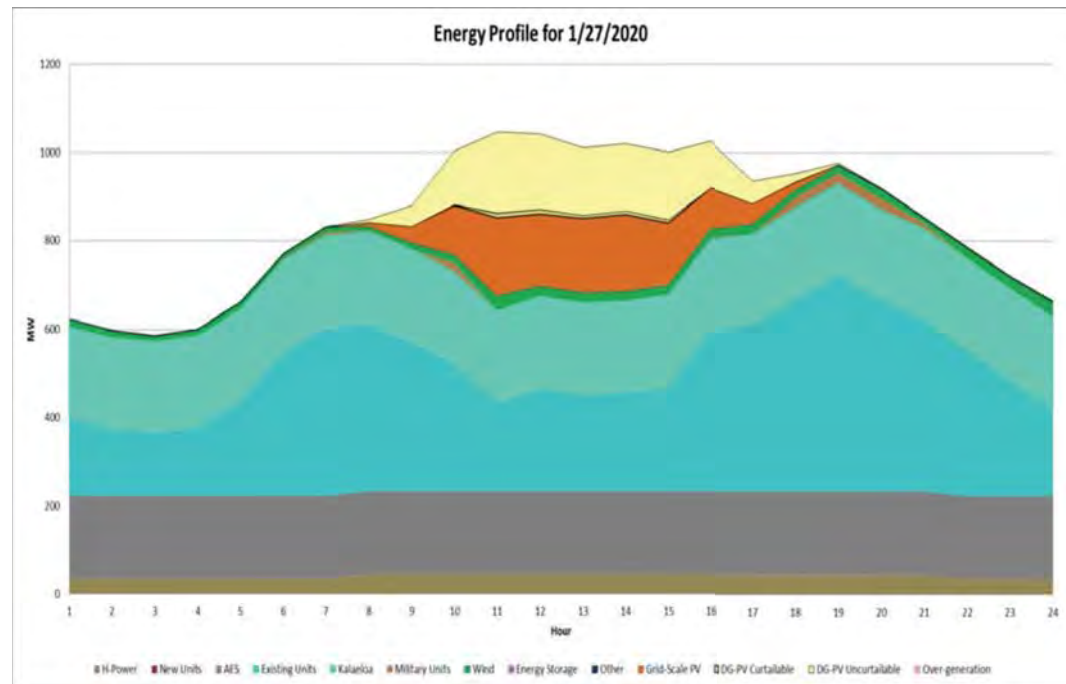

Figure K-30. Post-April PSIP Plan O'ahu Low Renewables Energy Profile: 2020

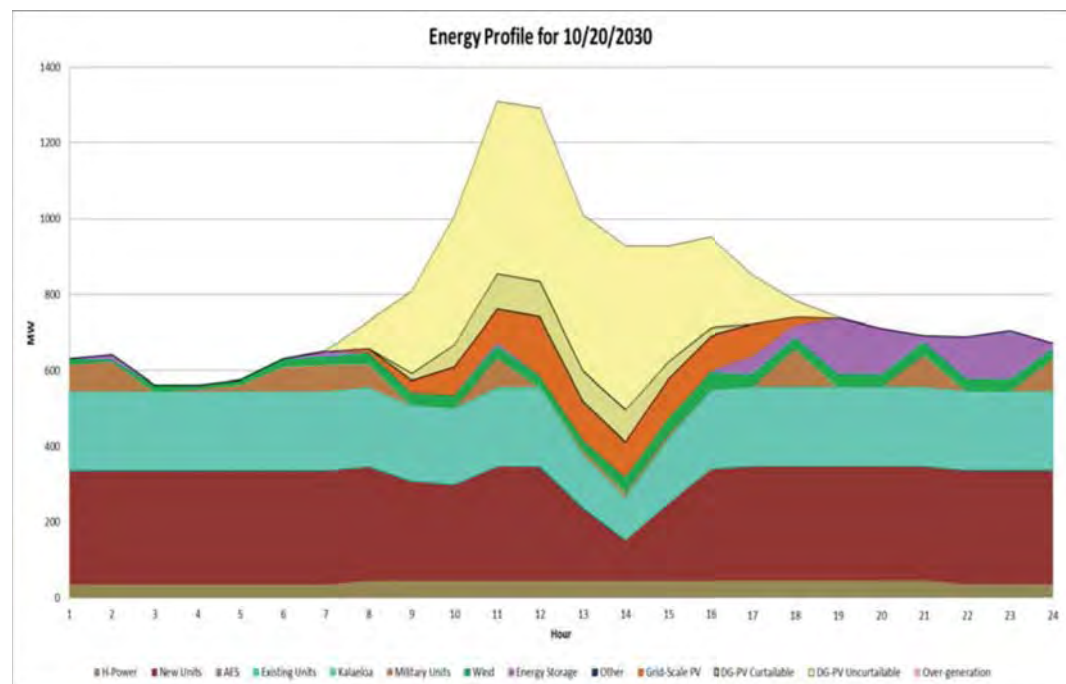

Figure K-31. Post-April PSIP Plan O'ahu Low Renewables Energy Profile: 2030

**K. Analytical Steps and Results**

O'ahu Analytical Steps and Results

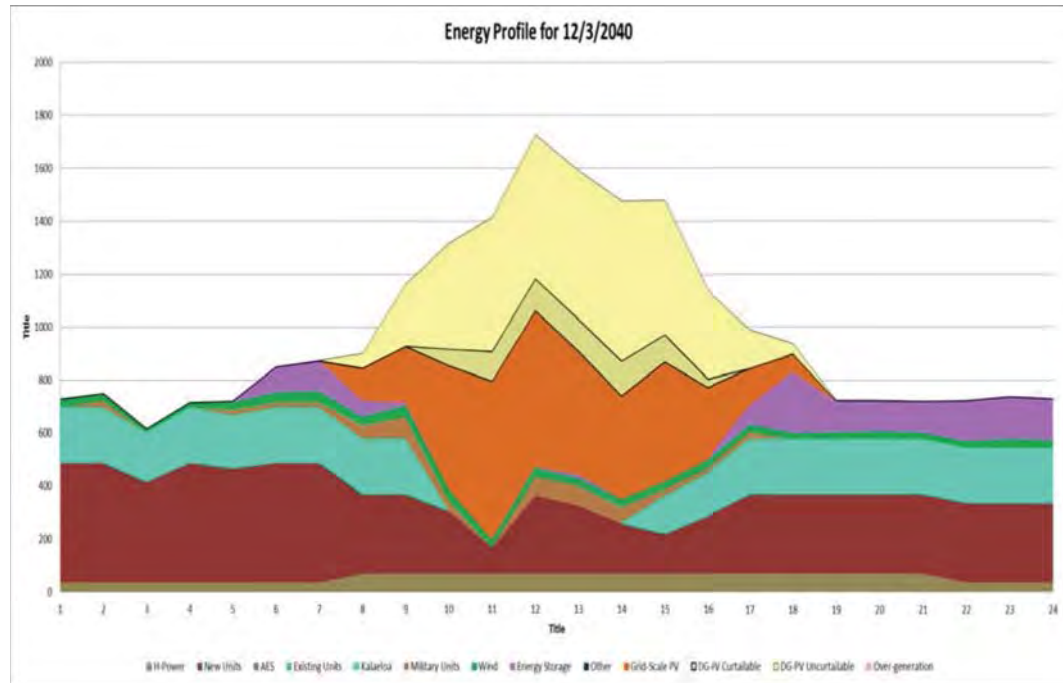

Figure K-32. Post-April PSIP Plan O'ahu Low Renewables Energy Profile: 2040

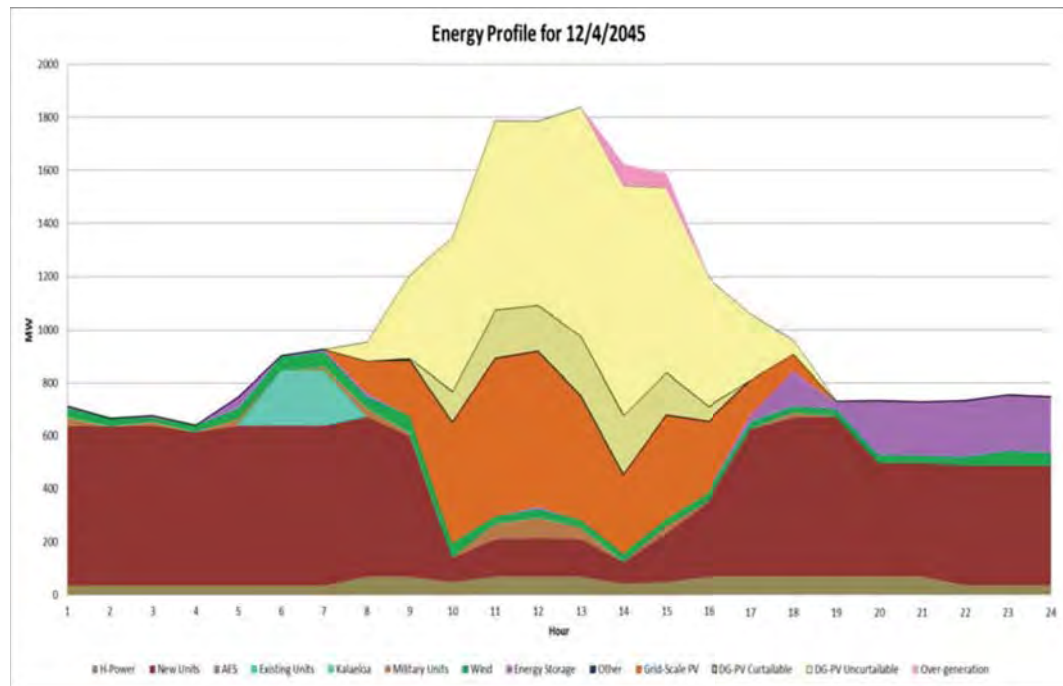

Figure K-33. Post-April PSIP Plan O'ahu Low Renewables Energy Profile: 2045

## K. Analytical Steps and Results

Maui Analytical Steps and Results

### MAUI ANALYTICAL STEPS AND RESULTS

The core cases analyzed for Maui outline different paths to achieving 100% renewable energy in 2045 as well as an accelerated target of 2040 consistent with the April 2016 PSIP.

#### Energy Mix of Maui Plans

Figure K-34 summarizes the annual RPS for each year.

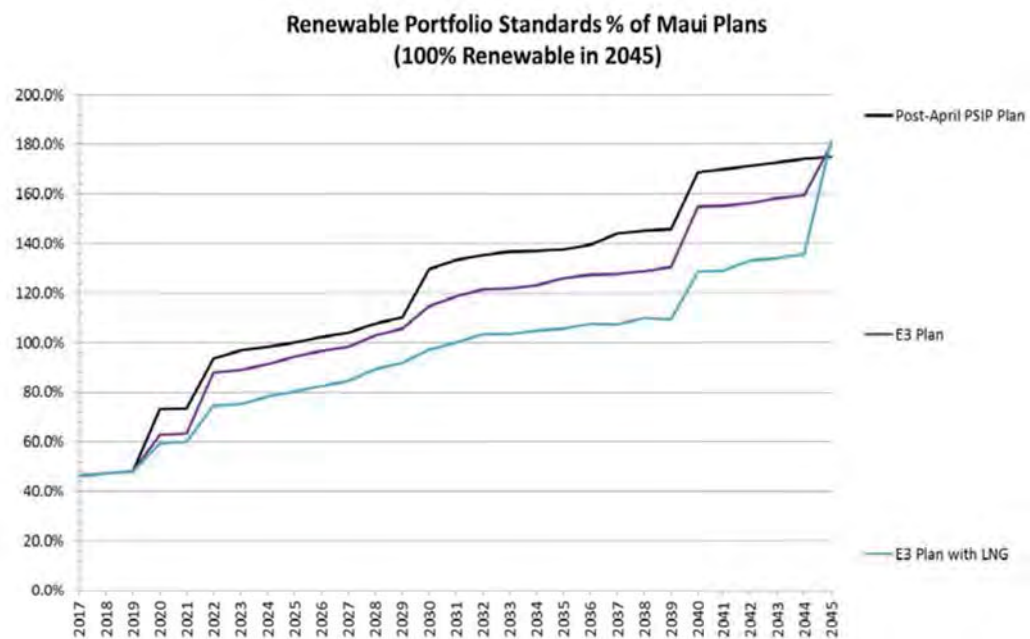

Figure K-34. Renewable Portfolio Standards Percent of Maui Plans

The calculation of the RPS per the law does result in values over 100%. To emphasize that we are committed to achieving 100% renewable energy in 2045, Figure K-35 shows the renewable energy as a percent of total energy including customer-sited generation.

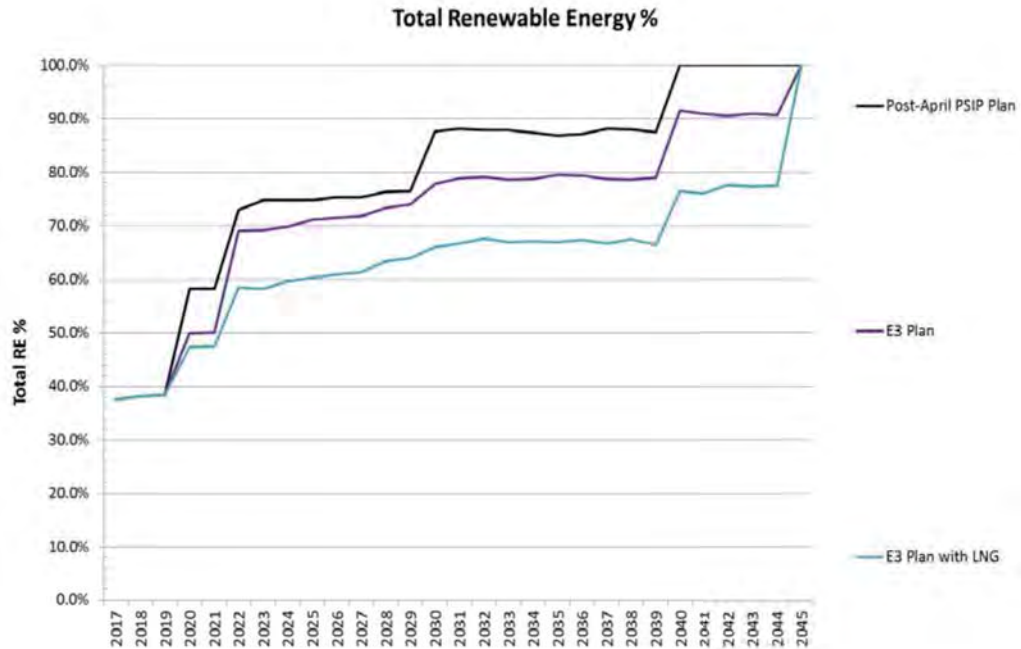

Figure K-35. Total Renewable Energy Percent of Maui Plans

The resource mix for the plans changes over time as it reaches 100% renewable in 2045 for the E3 plans and 100% renewable in 2040 for the Post-April PSIP Plan.. The figures below reveal how the energy mix in each plan grows to 100% renewable energy.

The annual energy served by resource type is shown in Figure K-36 for the Post-April PSIP Plan. The transition to renewable wind and solar can be easily seen as the fossil fuel (oil) significantly decreases over time.



## K. Analytical Steps and Results

### Maui Analytical Steps and Results

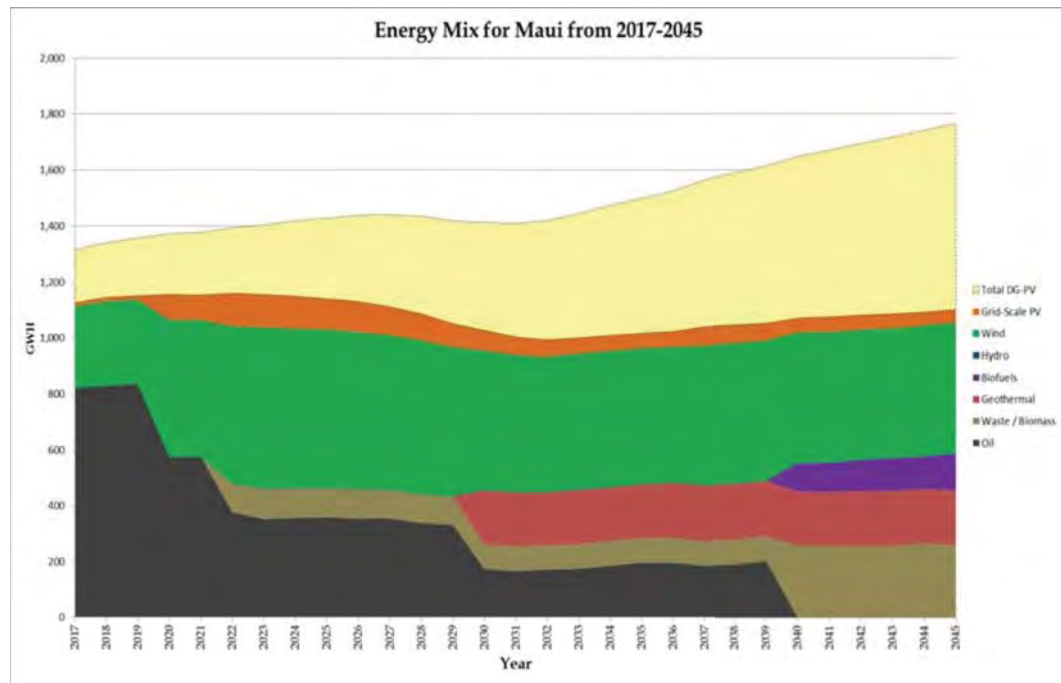

Figure K-36. Energy Mix for Post-April PSIP Plan on Maui

Figure K-37 shows the energy mix of the E3 Plan.

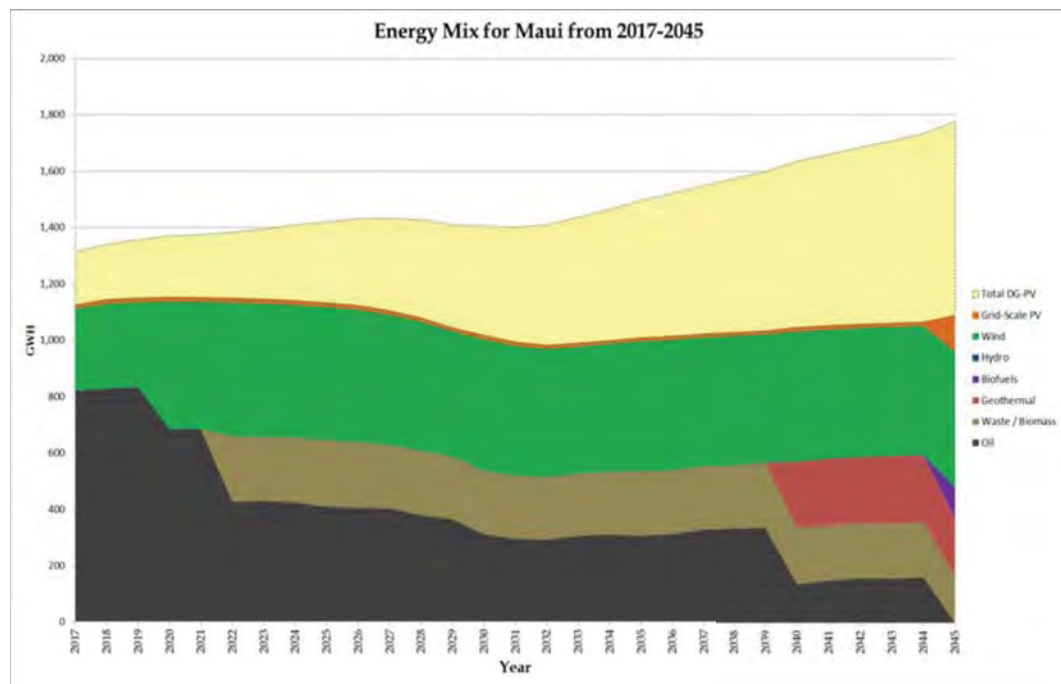

Figure K-37. Energy Mix for E3 Plan on Maui

The E3 Plan with LNG uses LNG as a transitional fuel from oil. Renewable energy is added economically to meet intermediate RPS targets and ultimately 100% renewable energy in 2045. The energy mix for E3 Plan with LNG is shown in Figure K-38. The

transition to LNG assumes a contract period of 2022–2041. During the last intervening years in the transition to 100% renewable energy, potential future resources at this time could include biofuels, LNG, oil, other renewable options or a mix of options. Given rapidly evolving energy options and technology, the exact fuel mix is difficult to predict today.

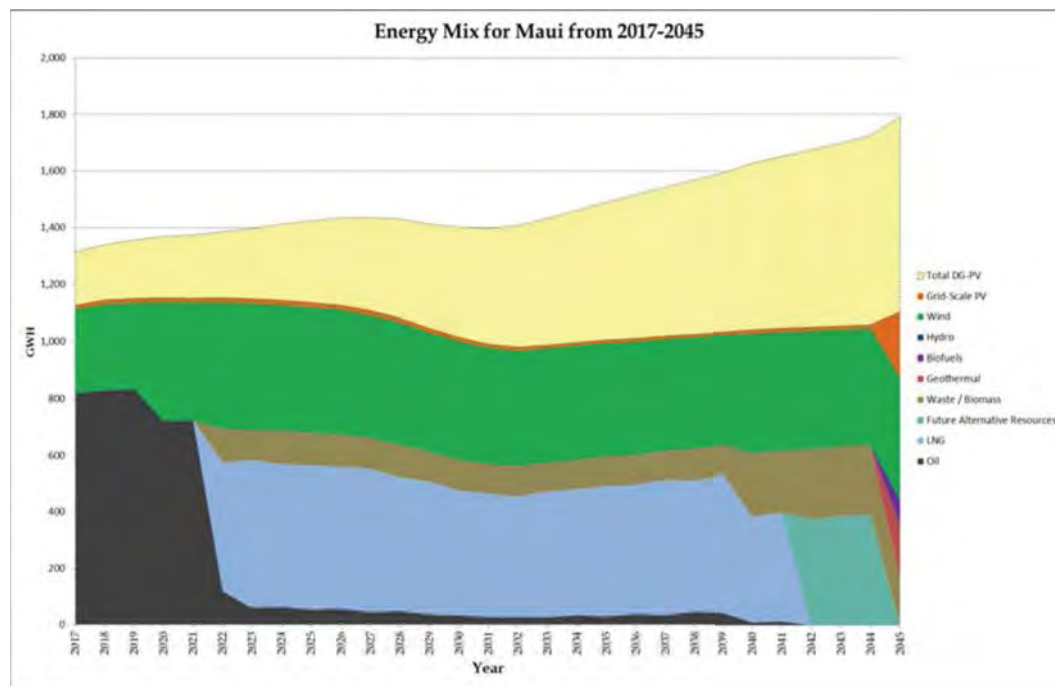

Figure K-38. Energy Mix for E3 Plan with LNG on Maui

### Percent Over-Generation of Total System for Maui Plans

As increasingly more renewable energy is added to the system, over-generation occurrences will become inevitable. Figure K-39 provides estimates of the percent over-generation of the total system annual energy for the various plans. Since the Post-April PSIP Plan integrates greater amounts of grid-scale PV and grid-scale wind energy than the E3 plans, the percent over-generation is significantly higher in the Post-April PSIP Plans than in the E3 plans. Although the E3 plans add energy storage which aids in reducing over-generation, over-generation still occurs. However, situations of over-generation provide opportunities, coupled with appropriate controls systems, to allow wind and solar generation to contribute to regulation up resources in addition to use as a reserve resource. This provides improved system performance. In combination, wind and solar used for energy and some level of regulation and reserve appears to be cheaper than the alternative of additional storage, at least at moderate over-generation levels. For the purposes of this December 2016 PSIP update (similar to the April 2016 PSIP update), we include the full cost of the grid-scale wind and grid-scale PV resources in cost

## K. Analytical Steps and Results

### Maui Analytical Steps and Results

calculations, regardless of over-generation levels and provide a simplified accounting for other services from these resources.

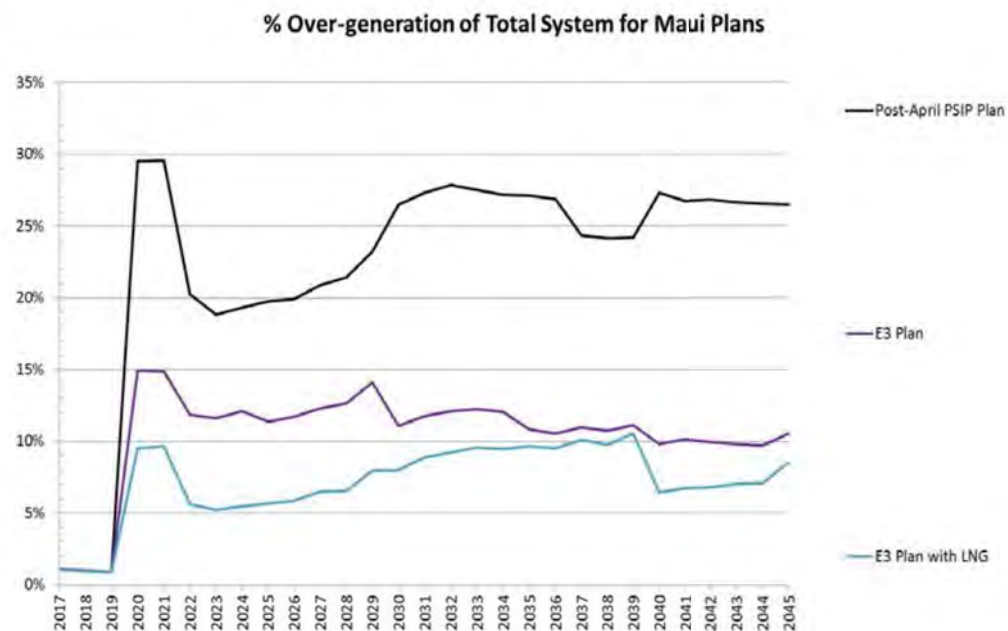

Figure K-39. Total System Over-Generation Percent for Maui Plans

### Unserviced Energy of Maui Plans

While periods of over-supply exist as described above, periods of unserved energy can also occur. The plans evaluate whether sufficient generation to serve load exists with variable renewable energy and storage with minimal conventional thermal resources on the system. The E3 plans identified existing conventional thermal generating units that could be considered for removal from service as an economic option. For the PLEXOS modeling of the E3 plans, these units were made unavailable to serve load or “offline”. If there was sufficient generation being provided by the remaining thermal resources, variable renewable resources, and storage, then there would not be any unserved energy. For the E3 Plan and Post-April PSIP Plan, there was virtually no unserved energy in the planning period.

## Seasonal Variations of Maui Renewable Energy

Although Maui has firm renewable resource options available, the majority of existing renewable energy is supplied through grid-scale wind that is highly seasonal as illustrated in the figures below.

Figure K-40 shows the difference between the load and the available renewable energy in the year 2025 for the E3 Plan. The difference must be met with thermal generation to prevent unserved energy.

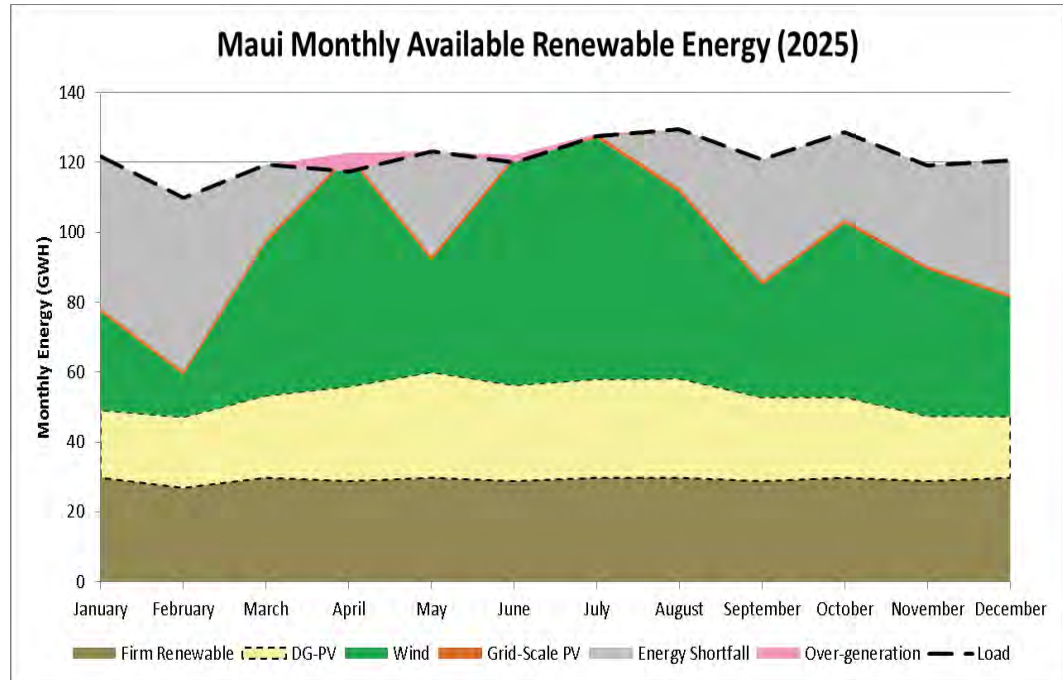

Figure K-40. E3 Plan Monthly Available Renewable Energy vs Load on Maui in 2025

Figure K-41 shows the difference between the load and the available renewable energy in the year 2045 for the E3 Plan. Despite having high amounts of renewable energy available in some months, creating a surplus, shown in pink, there are some months for which there is a deficit, shown in gray. This highlights the continued need for thermal generators to provide supplemental generation during these shortfall periods or energy storage systems, which are capable of shifting energy over several months from the months where there is a surplus to the months where there are shortfalls.

## K. Analytical Steps and Results

### Maui Analytical Steps and Results

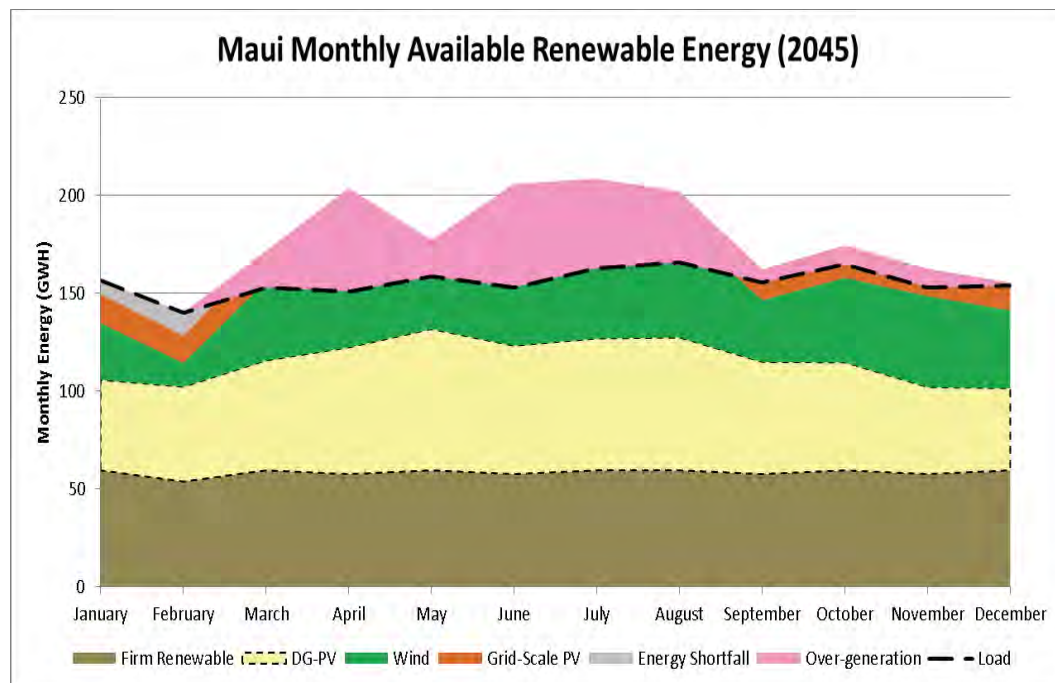

Figure K-41. E3 Plan Monthly Available Renewable Energy vs Load on Maui in 2045

### Sub-Hourly Charts of Maui Plans

Sub-hourly modeling was performed to analyze the impact that variable renewable energy would have on our system, and whether our portfolio of generators and storage systems would be sufficient to stabilize the electrical grid.

Historical minutely renewable energy data was used to determine the volatility of solar and wind resources on Maui. The volatility of the KWP1 wind farm was applied to future grid-scale wind resources, and the volatility of DG-PV was applied to future grid-scale PV resources.

An initial screening was done to determine the month with the largest potential minutely downward ramp. PLEXOS was then employed to perform a stochastic analysis on this month. Using the historical minutely data, stochastic variables were created for all as-available resources and the load. Shown below are the results from the sub-hourly analysis of the E3 Plan when a 1-, 15-, and 30-minute look-ahead is assumed.

Figure K-42 shows the estimated unserved energy at a 1 minute look-head.

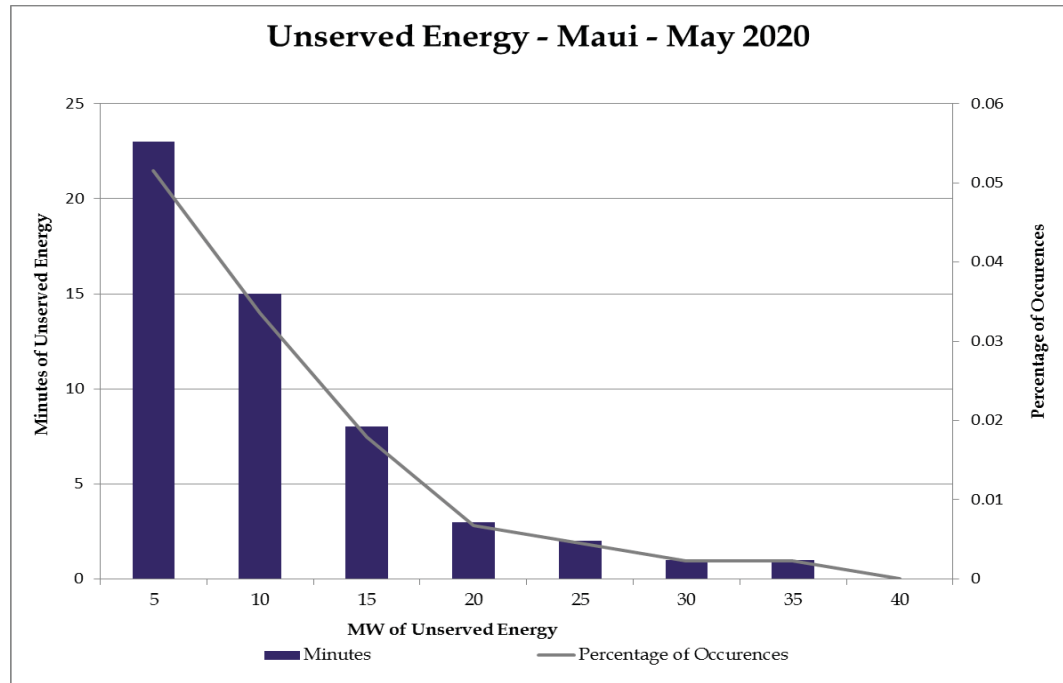

Figure K-42. Sub-Hourly Unserved Energy for E3 Plan on Maui at 15-Minute Look-Ahead

As shown in Figure K-43, the unserved energy magnitude and number of occurrences significantly decreases with 30 minute look-ahead.

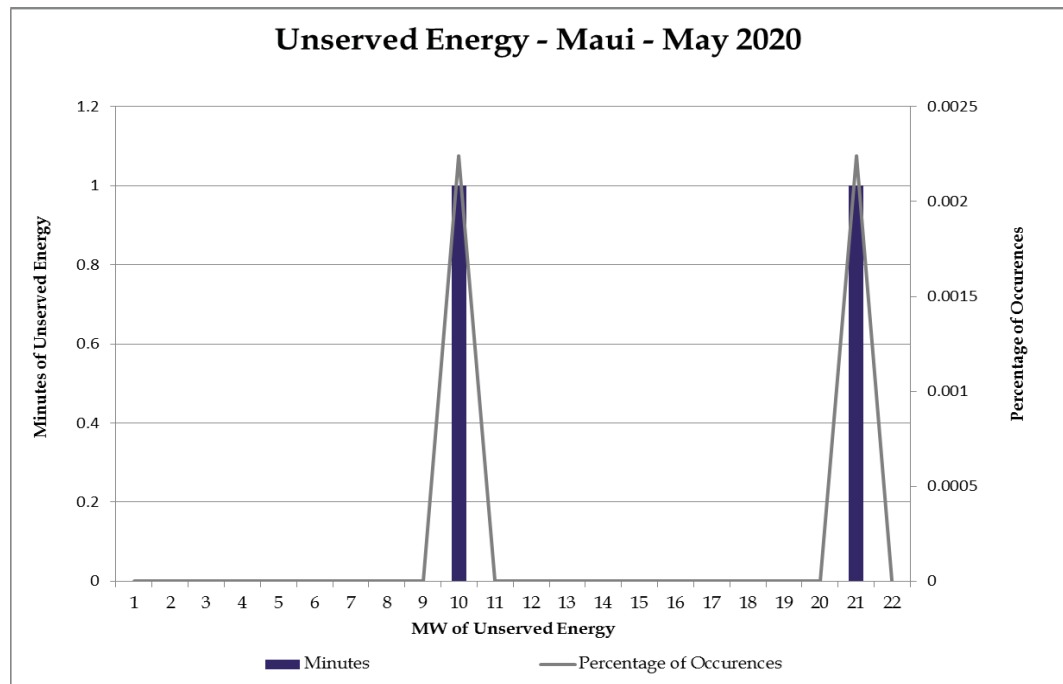

Figure K-43. Sub-Hourly Unserved Energy for E3 Plan on Maui at 30-Minute Look-Ahead

With a 30 minute look-ahead setting, there is virtually no unserved energy.

## K. Analytical Steps and Results

### Maui Analytical Steps and Results

#### Daily Energy Charts of Maui Plans

The charts in the previous sections displayed annual and monthly views of how renewable energy is integrated into the plans and the impacts to the system energy production. This section will convey a more granular view by providing the energy mix for select days of some years of the plans that were modeled.

#### High Over-Generation Energy Profiles for E3 Plan

Figure K-44 provides a view of the day in the year 2020 that has the highest amount of over-generation for the E3 Plan.

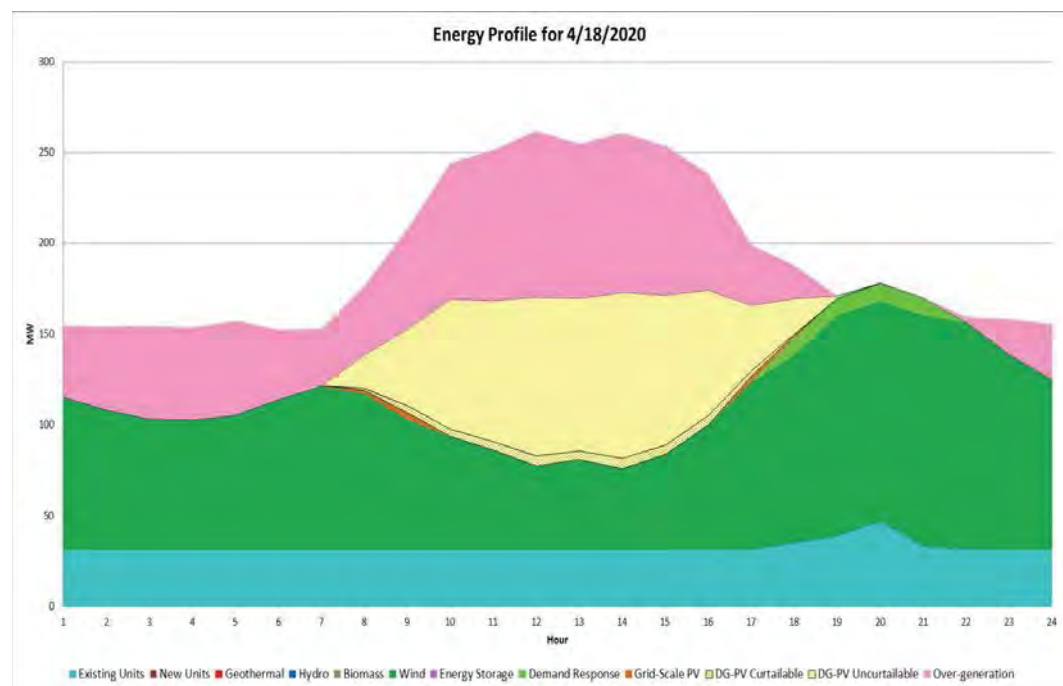

Figure K-44. E3 Plan Maui High Over-Generation Energy Profile: 2020

The day in 2030 that has the highest amount of over-generation for the E3 Plan is shown in Figure K-45. It can be seen that during the middle of the day, virtually all of the load is being served by renewable energy. The energy storage is being charged during the day during the periods of high over-generation and then discharged to serve load in the early morning and evening hours. .

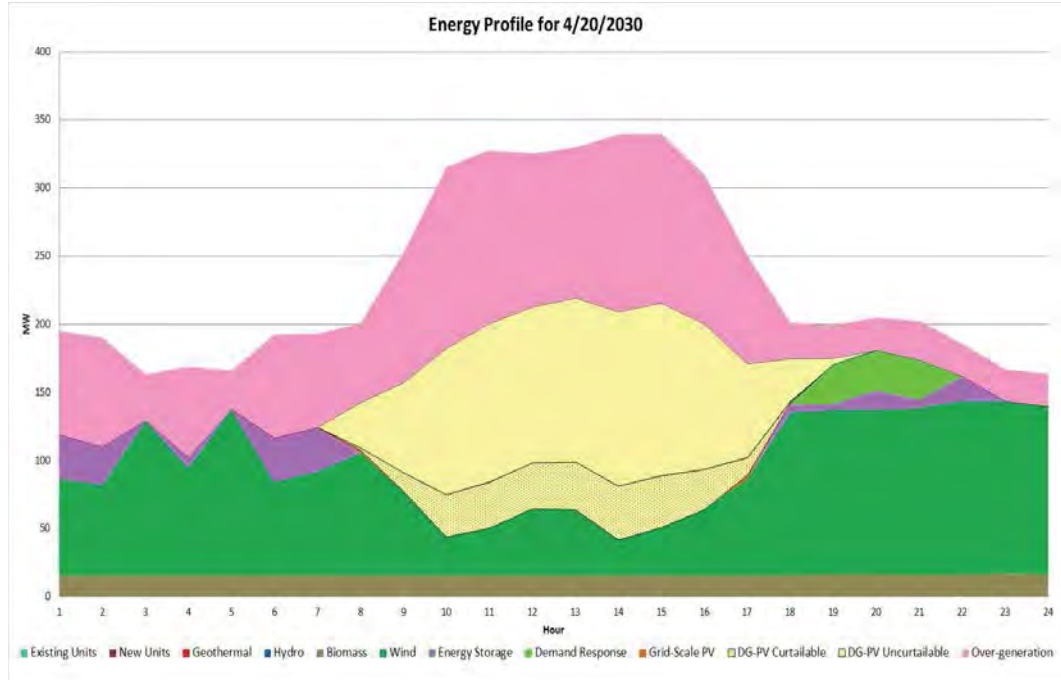

Figure K-45. E3 Plan Maui High Over-Generation Energy Profile: 2030

Figure K-46 and Figure K-47 show similar daily profiles in 2040 and 2045 as shown previously for 2030, but with more energy storage utilized.

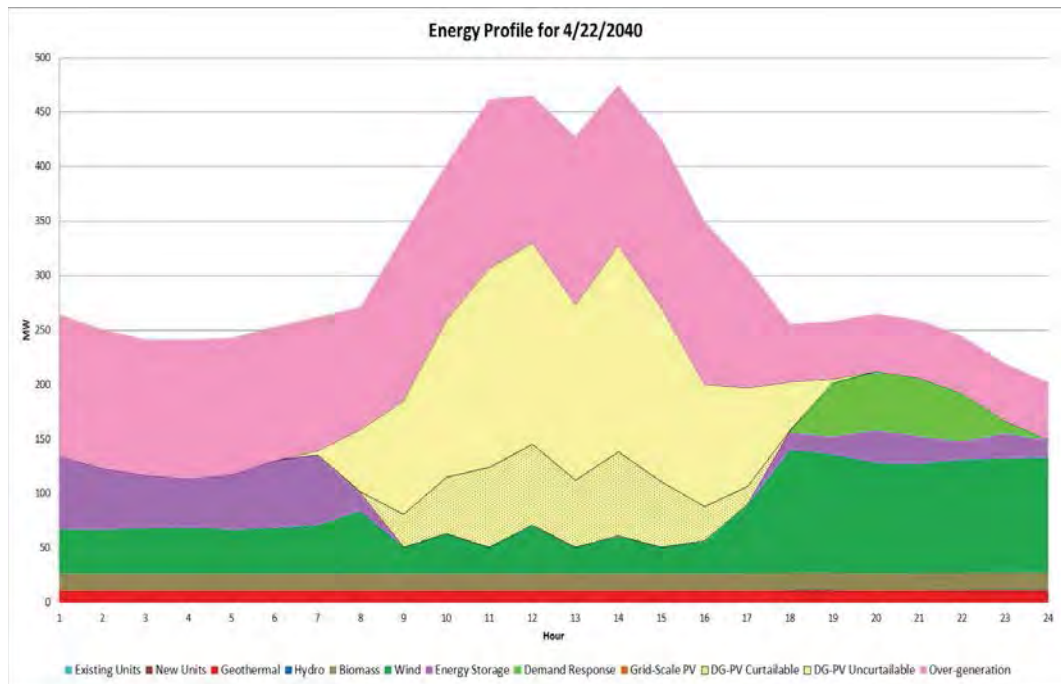

Figure K-46. E3 Plan Maui High Over-Generation Energy Profile: 2040



## K. Analytical Steps and Results

### Maui Analytical Steps and Results

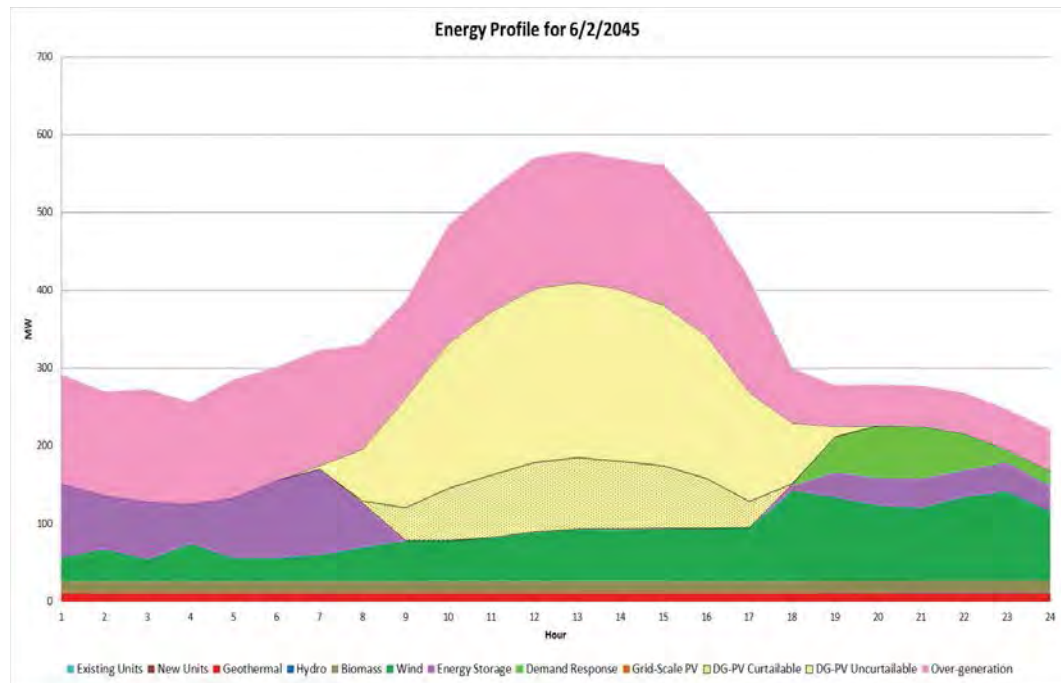

Figure K-47. E3 Plan Maui High Over-Generation Energy Profile: 2045

### Low Renewable Energy Profiles for E3 Plan

Although Hawai'i has abundant renewable resources, such as wind and solar, there are days for which there is limited solar and/or limited or no wind available. Figure K-48, Figure K-49, Figure K-50, and Figure K-51 illustrate how different the energy profile is on days with low renewable energy available in the years 2020, 2030, 2040, and 2045, respectively, for the E3 Plan. Even in later years, such as 2040 and 2045, where there are significant amounts of renewable resources and energy storage included in the plan, on these low renewable days, thermal generation is still necessary to serve the load.

**K. Analytical Steps and Results**

Maui Analytical Steps and Results

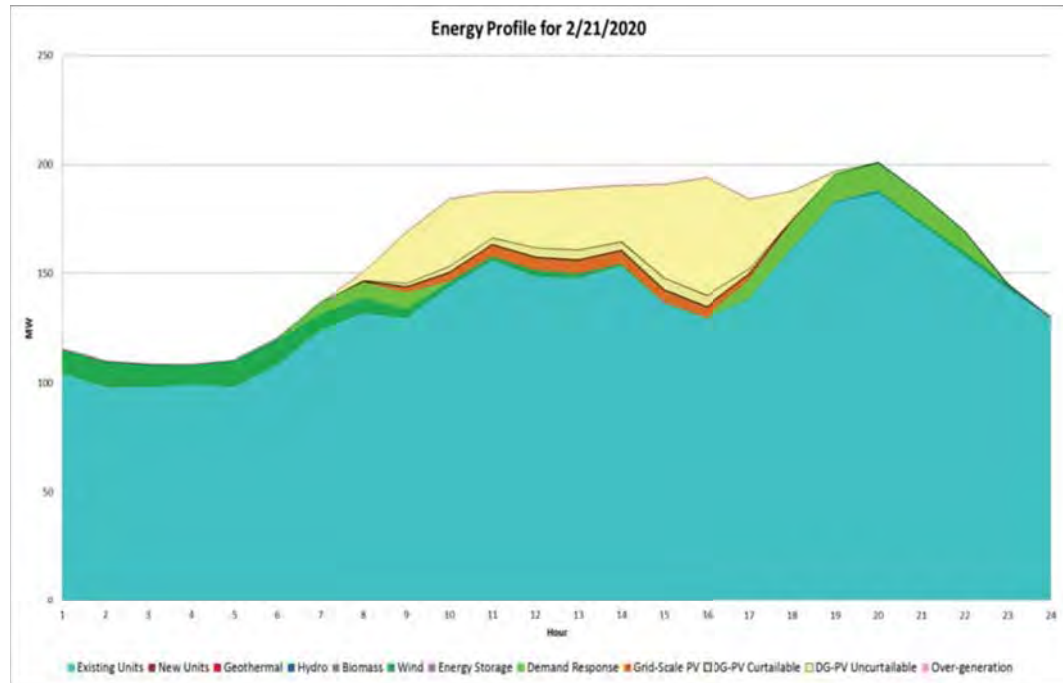

Figure K-48. E3 Plan Maui Low Renewables Energy Profile: 2020

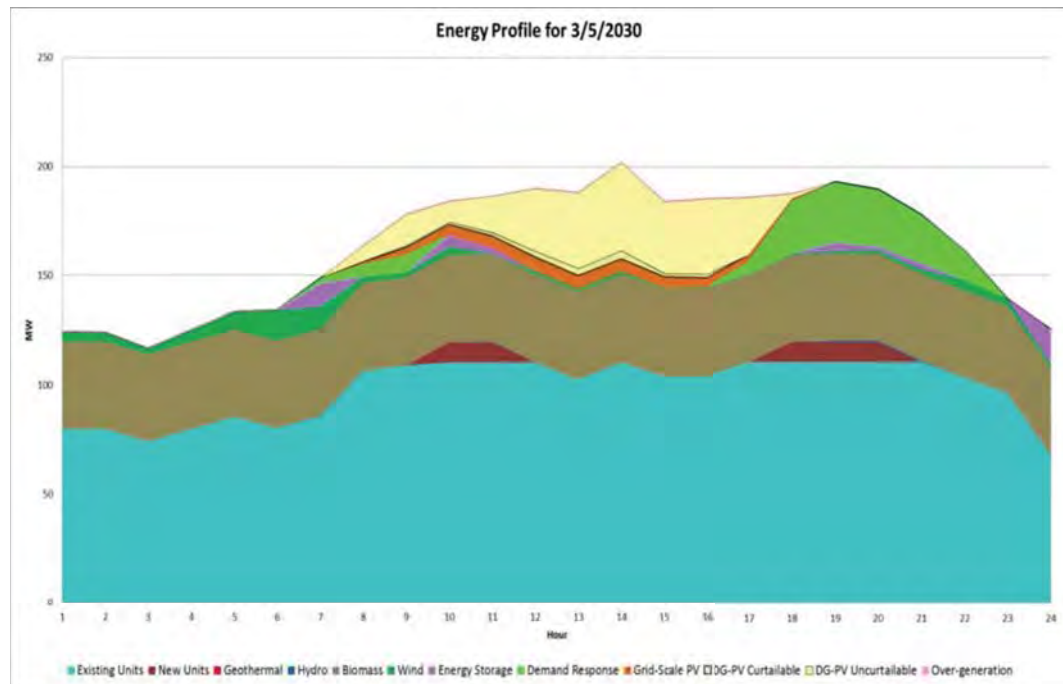

Figure K-49. E3 Plan Maui Low Renewables Energy Profile: 2030

## K. Analytical Steps and Results

### Maui Analytical Steps and Results

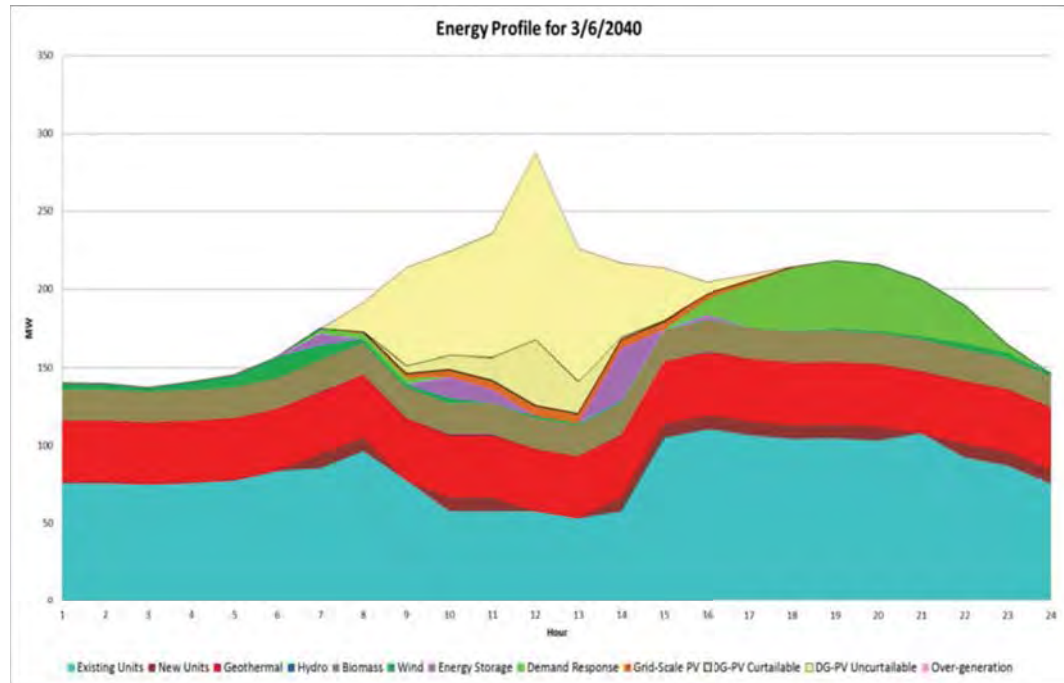

Figure K-50. E3 Plan Maui Low Renewables Energy Profile: 2040

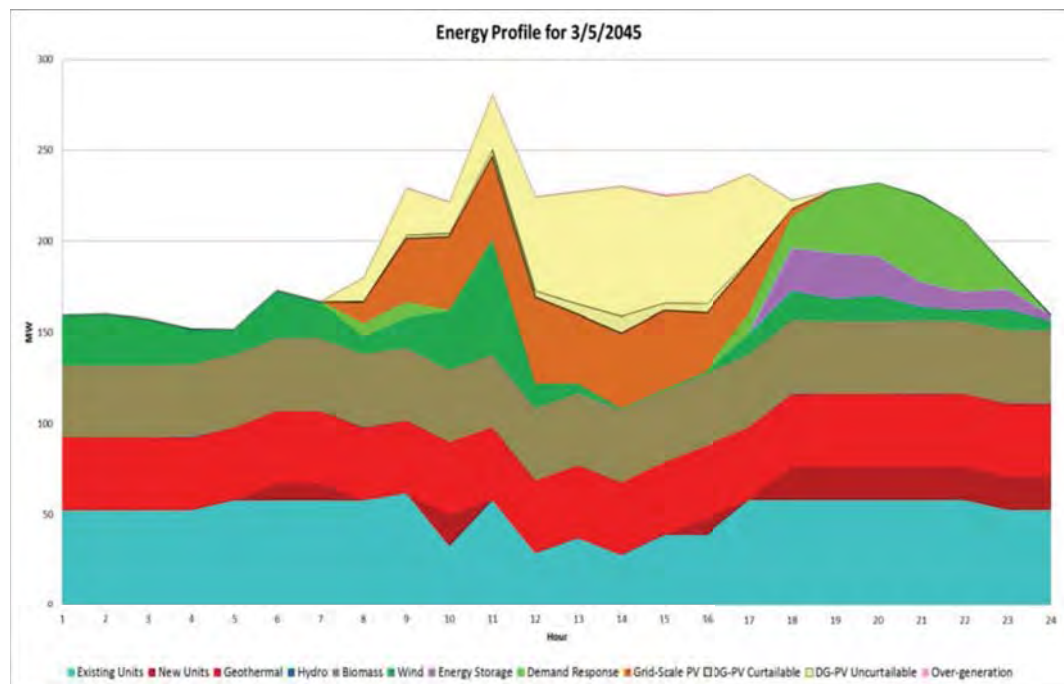

Figure K-51. E3 Plan Maui Low Renewables Energy Profile: 2045

### High Over-Generation Energy Profiles for Post-April PSIP Plan

Since the Post-April PSIP Plan has a different resource mix than the E3 plans, the daily energy profiles for the same years (2020, 2030, 2040, and 2045) are provided below.

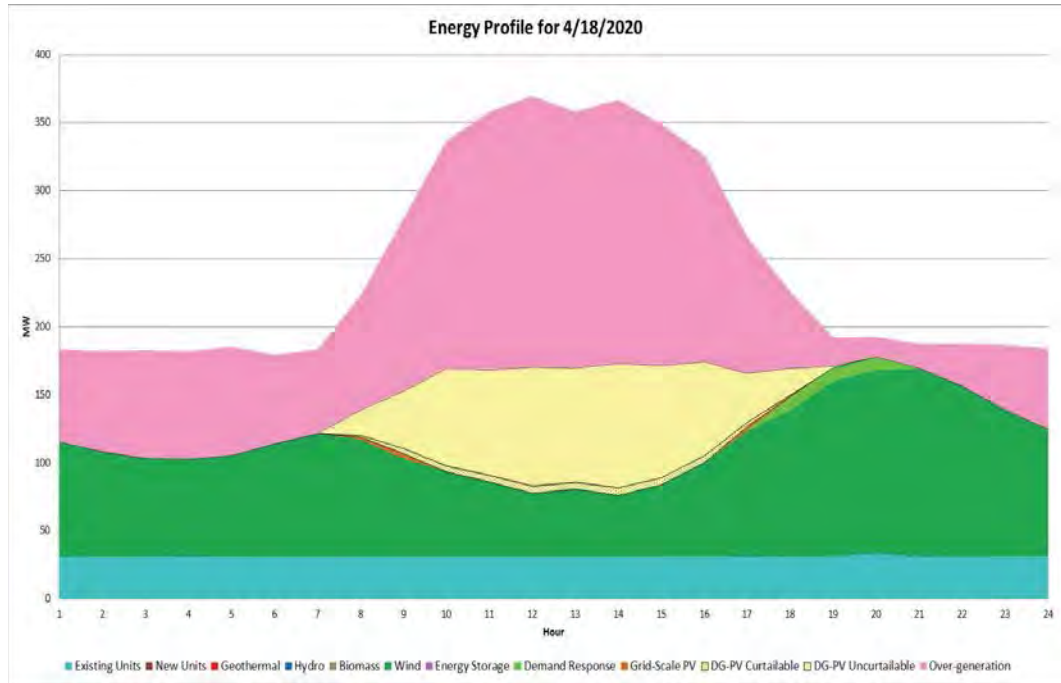

Figure K-52. Post-April PSIP Plan Maui High Over-Generation Energy Profile: 2020

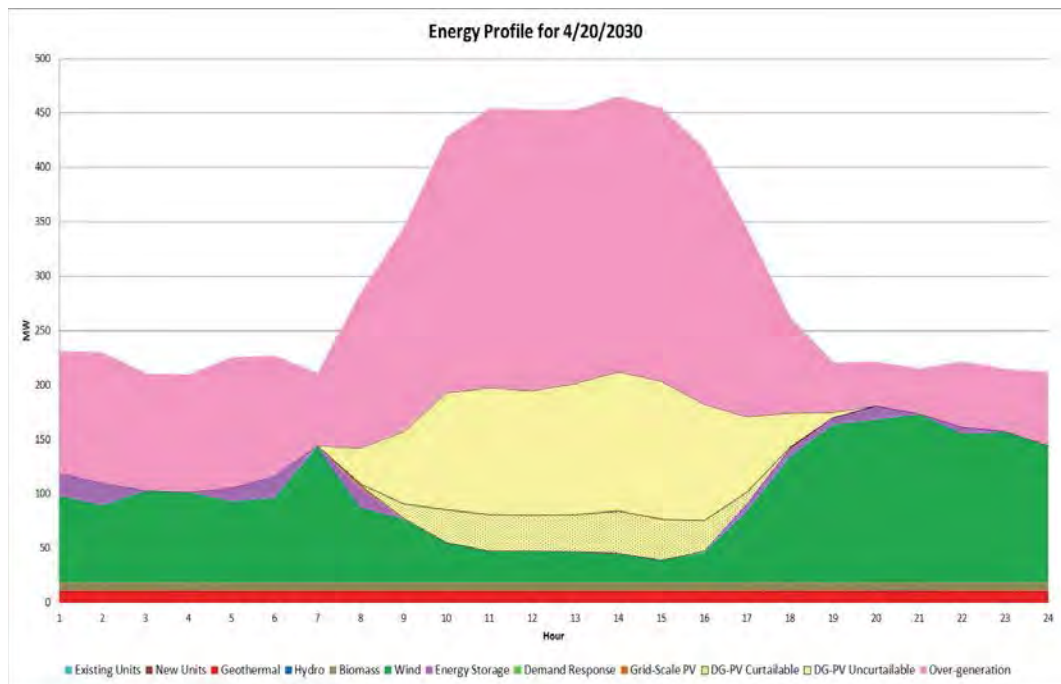

Figure 4-53. Post-April PSIP Plan Maui High Over-Generation Energy Profile: 2030

## K. Analytical Steps and Results

### Maui Analytical Steps and Results

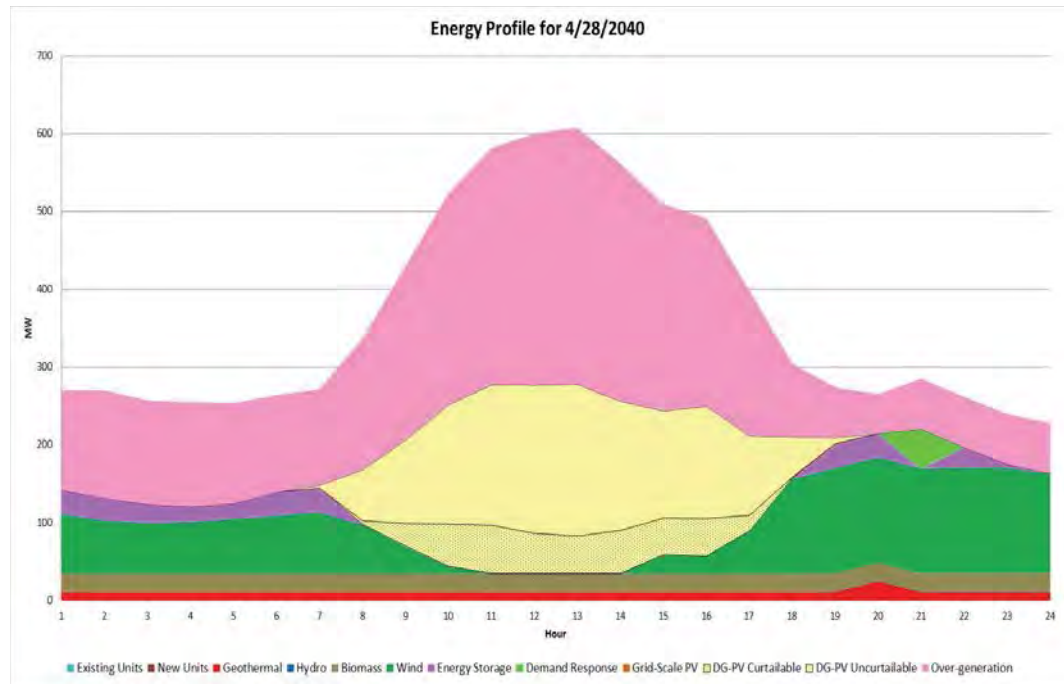

Figure K-54. Post-April PSIP Plan Maui High Over-Generation Energy Profile: 2040

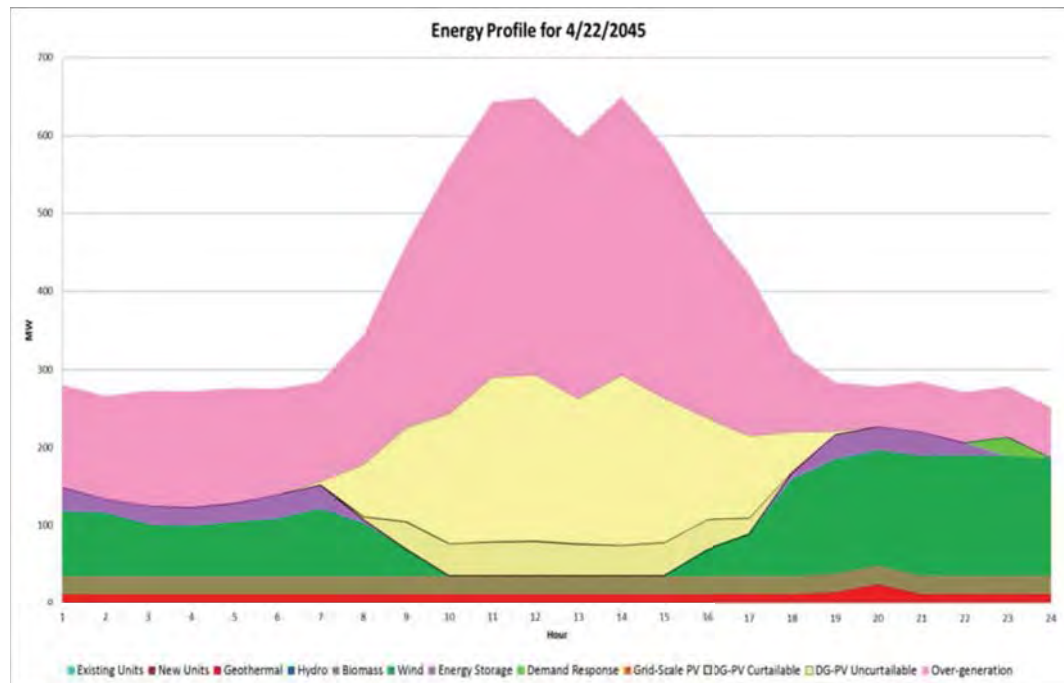

Figure K-55. Post-April PSIP Plan Maui High Over-Generation Energy Profile: 2045

### Low Renewable Energy Profiles for Post-April PSIP Plan

The daily energy profiles for the same years (2020, 2030, 2040, and 2045) for the Post-April PSIP Plan are provided below as a comparison to the E3 plans.

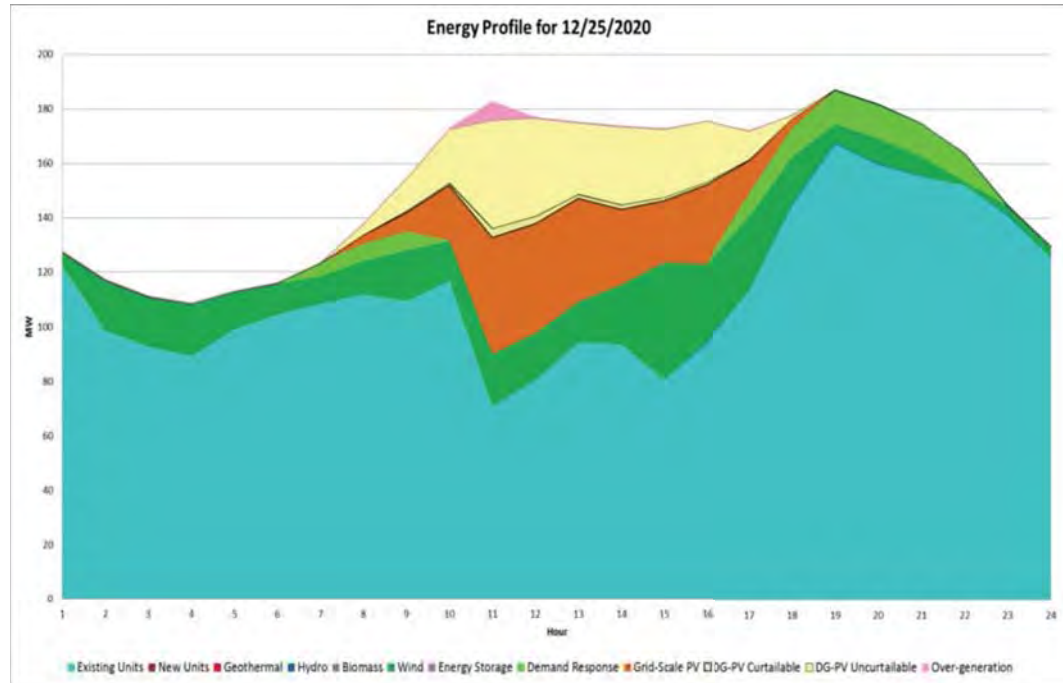

Figure K-56. Post-April PSIP Plan Maui Low Renewables Energy Profile: 2020

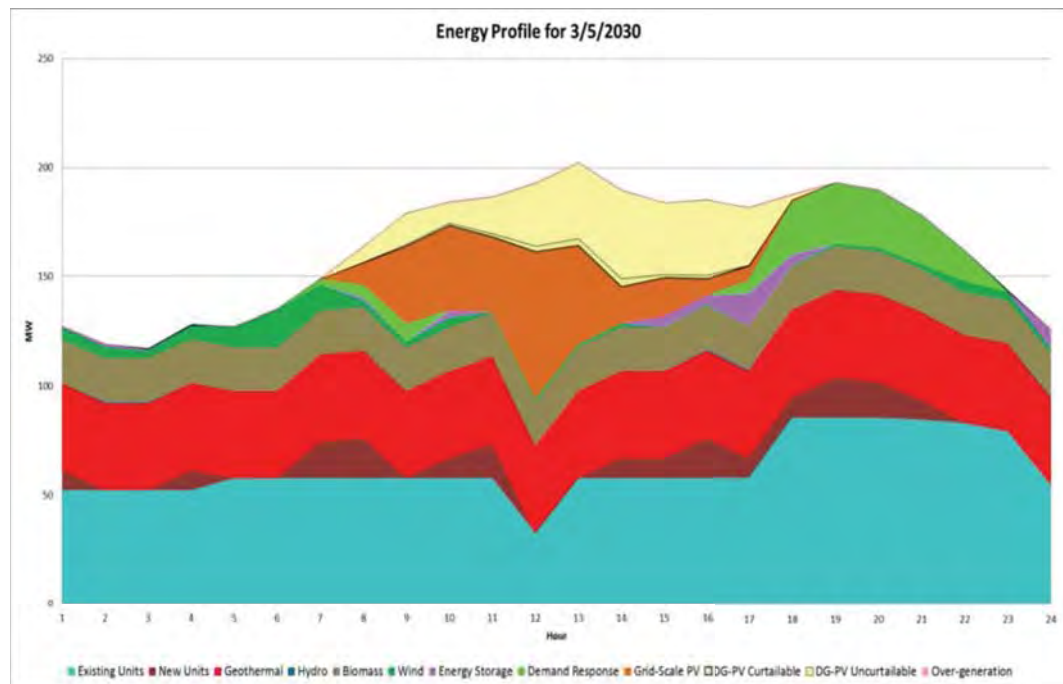

Figure K-57. Post-April PSIP Plan Maui Low Renewables Energy Profile: 2030

## K. Analytical Steps and Results

### Maui Analytical Steps and Results

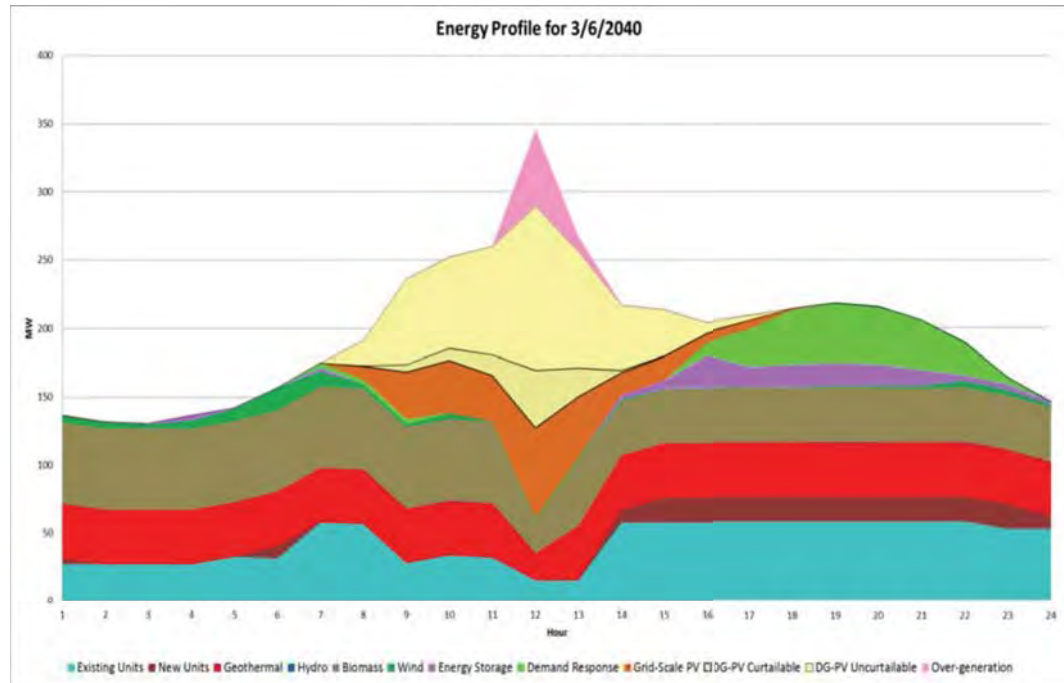

Figure K-58. Post-April PSIP Plan Maui Low Renewables Energy Profile: 2040

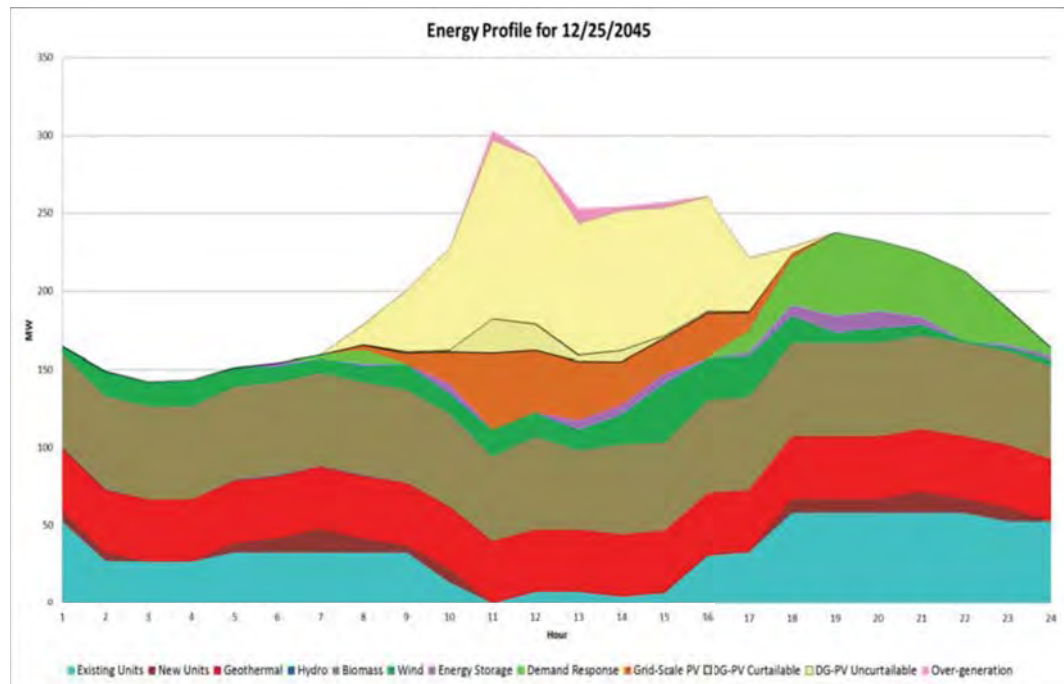

Figure K-59. Post-April PSIP Plan Maui Low Renewables Energy Profile: 2045

## MOLOKA'I ANALYTICAL STEPS AND RESULTS

The core cases analyzed for Moloka'i outline different paths to achieving 100% renewable energy in 2020 and 2030.

### Energy Mix of Moloka'i Plans

Figure K-60 summarizes the annual RPS for each year.

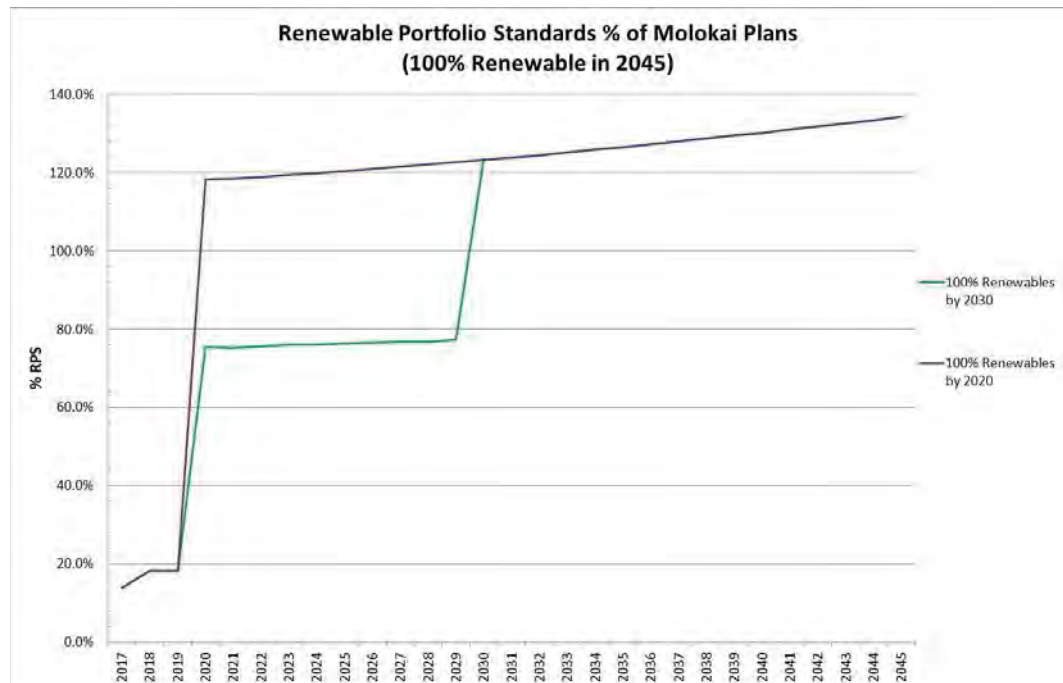

Figure K-60. Renewable Portfolio Standards Percent of Moloka'i Plans

The calculation of the RPS per the law does result in values over 100%. Accelerated targets of 100% renewable energy by 2020 and 100% renewable energy by 2030 are shown in Figure K-61, which includes renewable energy as a percent of total energy including customer-sited generation.



## K. Analytical Steps and Results

### Moloka'i Analytical Steps and Results

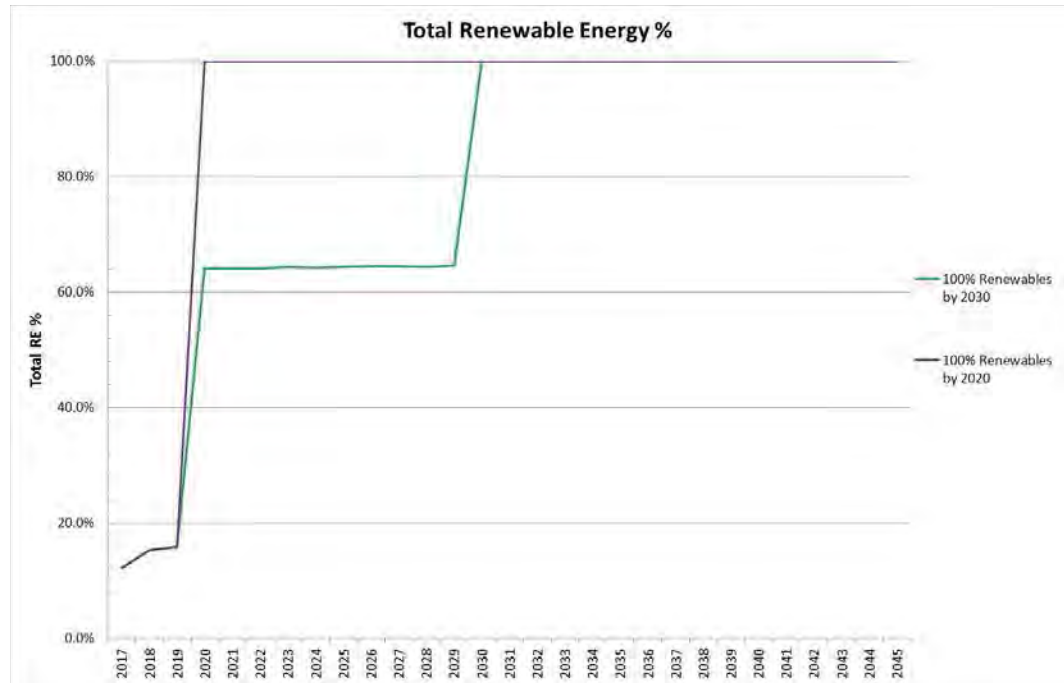

Figure K-61. Total Renewable Energy Percent of Moloka'i Plans

The resource mix for the plans changes over time as it reaches 100% renewable. The figures below reveal how the energy mix in each plan grows to 100% renewable energy.

The annual energy served by resource type is shown in Figure K-62 for the 100% Renewables by 2020 Plan. Although the addition of grid-scale wind in the year 2020 provides a significant amount of energy, there is still a significant amount of biofuel utilized to achieve 100% renewable energy.

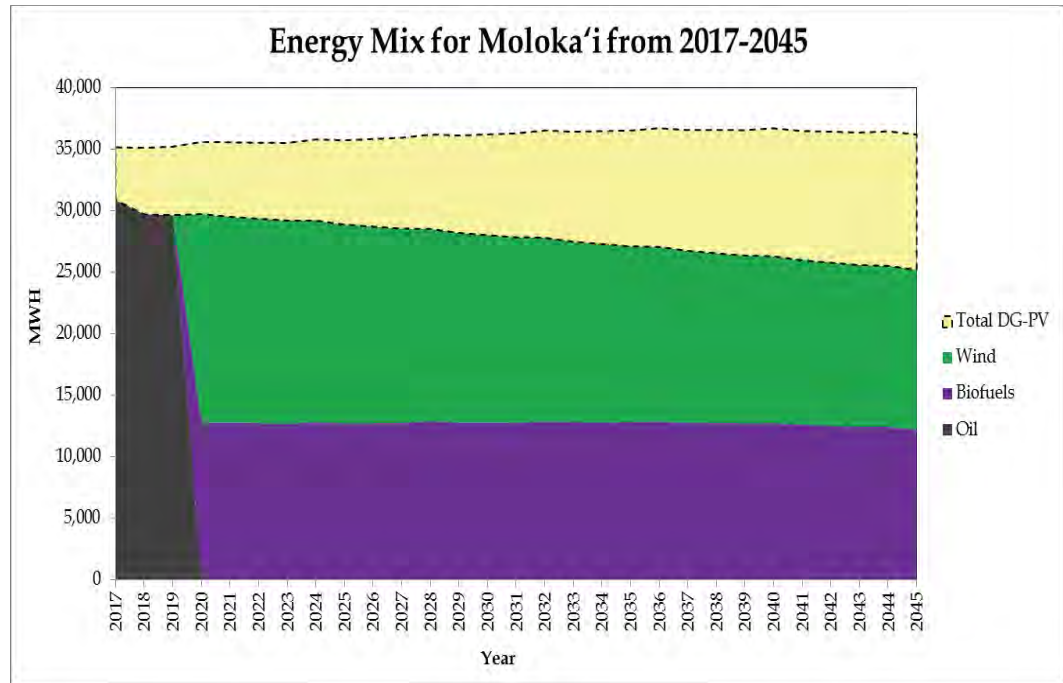

Figure K-62. Energy Mix for 100% Renewables by 2020 Plan on Moloka'i

Figure K-63 shows the energy mix of the 100% Renewables by 2030 Plan.

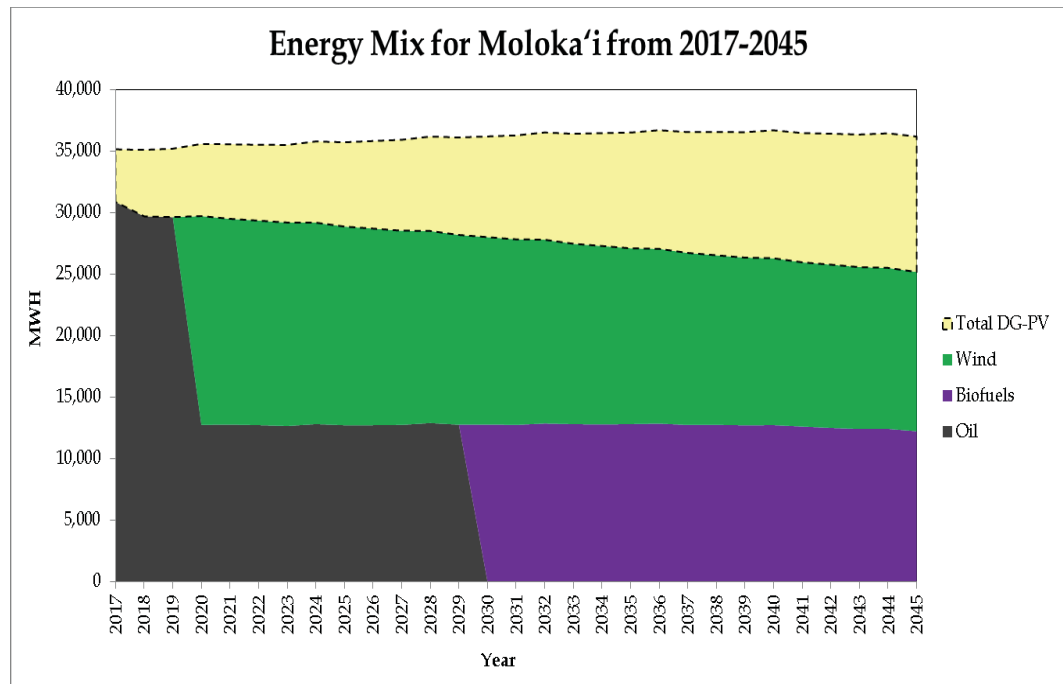

Figure K-63. Energy Mix for 100% Renewables by 2030 Plan on Moloka'i

## K. Analytical Steps and Results

### Moloka'i Analytical Steps and Results

#### Percent Over-Generation of Total System for Moloka'i Plans

As increasingly more renewable energy is added to the system, over-generation occurrences will become inevitable. Figure K-64 provides estimates of the percent over-generation of the total system annual energy for the 100% Renewable by 2020 and 100% Renewable by 2030 plans. Both cases add 5 MW of grid-scale wind in 2020 at which time over-generation significantly increases. Both plans have similar annual over-generation since the resource plans are identical. Situations of over-generation provide opportunities, coupled with appropriate controls systems, to allow wind and solar generation to contribute to regulation up resources in addition to use as a reserve resource. This provides improved system performance. In combination, wind and solar used for energy and some level of regulation and reserve appears to be cheaper than the alternative of additional storage, at least at moderate over-generation levels. For the purposes of this December 2016 PSIP update (similar to the April 2016 PSIP update), we include the full cost of the grid-scale wind and solar resources in cost calculations, regardless of over-generation levels and provide a simplified accounting for other services from these resources.

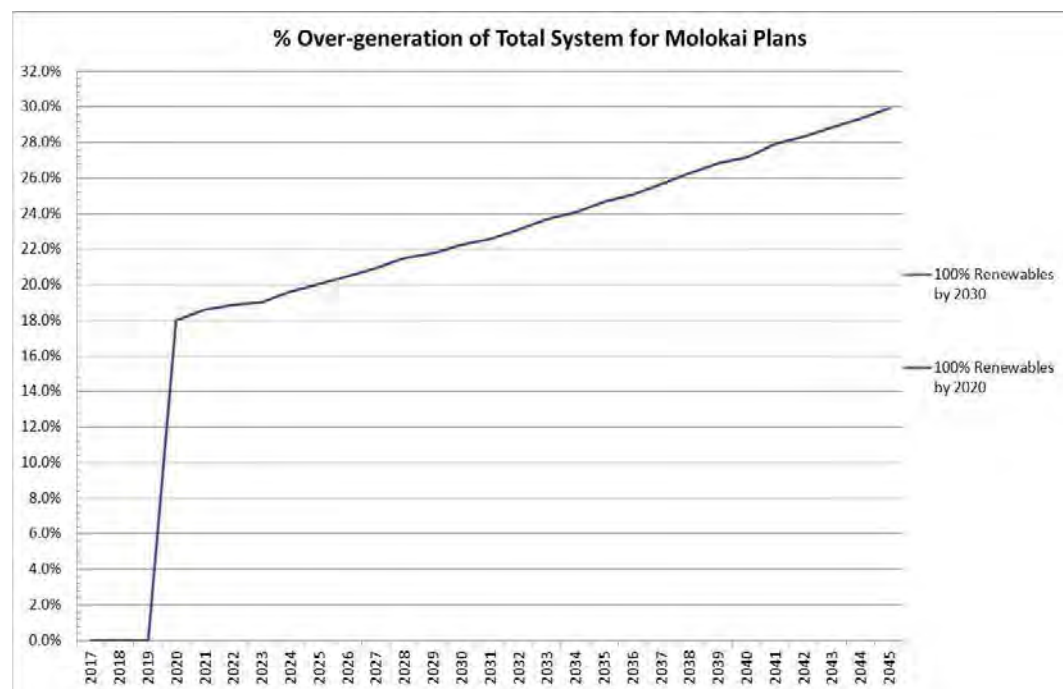

Figure K-64. Total System Over-Generation Percent for Moloka'i Plans

#### Unserved Energy of Moloka'i Plans

While periods of over-supply exist as described above, periods of unserved energy can also occur. The plans evaluate whether sufficient generation to serve load exists with variable renewable energy and minimal conventional thermal resources on the system. If

there was sufficient generation being provided by the remaining thermal resources, variable renewable resources, and storage, then there would not be any unserved energy. The year-by-year amount of unserved energy in hours and energy for the 100% Renewable by 2020 Plan is shown in Figure K-65. For example, in 2020, there are approximately 0.56 kWh total of unserved energy that occurs over the course of two hours in that year.

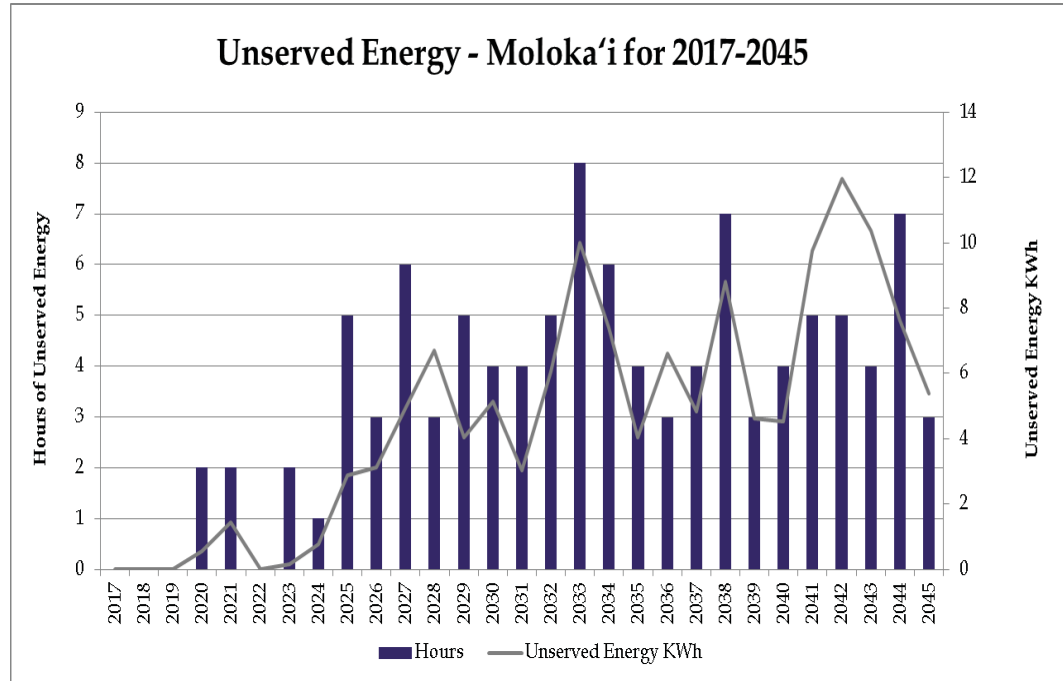

Figure K-65. Unserved Energy for 100% Renewables by 2020 Plan on Moloka'i

The unserved energy for the 100% Renewable by 2030 Plan is similar to the 100% Renewable by 2020 Plan since the resource plans are identical.

### Seasonal Variations of Moloka'i Renewable Energy

The resource plans optimized using the PLEXOS model include considerable amounts of grid-scale wind, 5 MW, in 2020 for both the 100% Renewable by 2020 and 100% Renewable by 2030 plans. The seasonality of available grid-scale wind is shown in the figures below.

Figure K-66 shows the difference between the load and the available renewable energy in the year 2025. The difference must be met with thermal generation to prevent unserved energy.

## K. Analytical Steps and Results

### Moloka'i Analytical Steps and Results

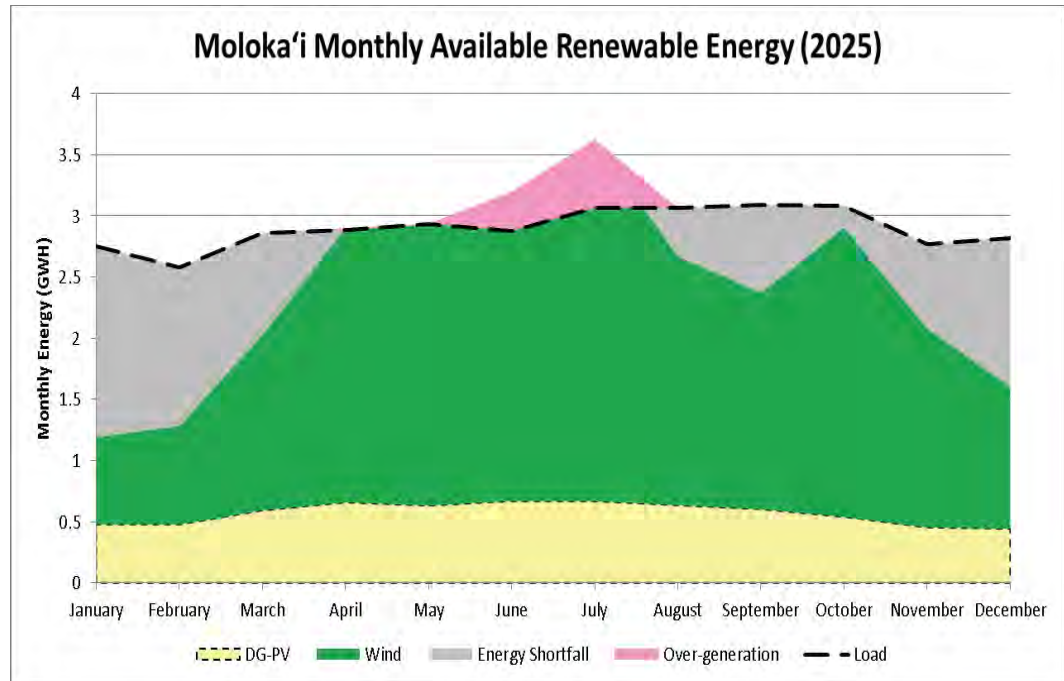

Figure K-66. 100% Renewable by 2020 Plan Monthly Available Renewable Energy vs Load on Moloka'i in 2025

Figure K-67 shows the difference between the load and the available renewable energy in the year 2045. Despite having high amounts of renewable energy available in some months, creating a surplus, shown in pink, there are some months for which there is a deficit, shown in gray. This highlights the continued need for thermal generators to provide supplemental generation during these shortfall periods or energy storage systems, which are capable of shifting energy over several months from the months where there is a surplus to the months where there are shortfall.

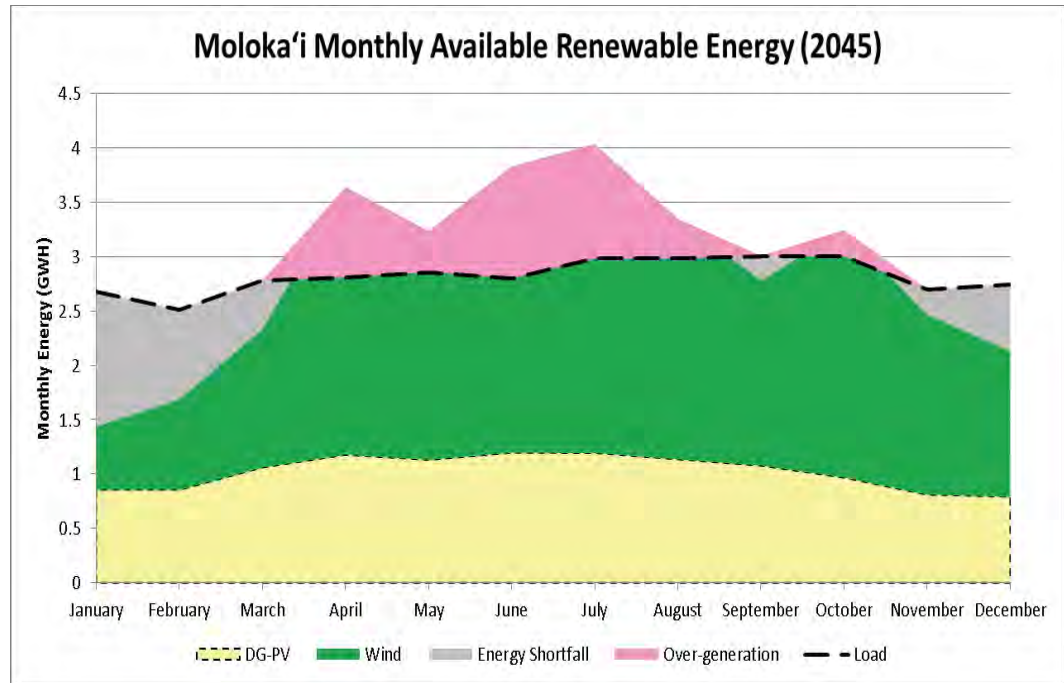

Figure K-67. 100% Renewable by 2020 Plan Monthly Available Renewable Energy vs Load on Moloka'i in 2045

### Sub-Hourly Charts of Moloka'i Plans

Sub-hourly modeling was performed to analyze the impact that variable renewable energy would have on our system, and whether our portfolio of generators and storage systems would be sufficient to stabilize the electrical grid.

Due to limited data available on Moloka'i, historical minutely renewable energy data from Maui was used to determine the volatility of solar and wind resources on Moloka'i. Historical minutely load data from Moloka'i was used. The volatility of the Auwahi wind farm was applied to future grid-scale wind resources.

An initial screening was done to determine the month with the largest potential minutely downward ramp. PLEXOS was then employed to perform a stochastic analysis on this month. Using the historical minutely data, stochastic variables were created for all as-available resources and the load.

There was virtually no unserved energy in the sub-hourly analysis for Moloka'i in both the 100% Renewable by 2020 and 100% Renewable by 2030 cases when a 1-, 15-, and 30-minute look-ahead was assumed. However, as described in Chapter 4, no regulation requirements were included for the Moloka'i PLEXOS modeling, thus further analysis is needed to determine whether there are sufficient resources to integrate high levels of variable renewable generation on Moloka'i. It should be noted that in actual operations no perfect look ahead is possible, regardless of the time duration.

## K. Analytical Steps and Results

### Moloka'i Analytical Steps and Results

#### Daily Energy Charts of Moloka'i Plans

The charts in the previous sections displayed annual and monthly views of how renewable energy is being integrated into the plans and the impacts to the system energy production. This section will convey a more granular view by providing the energy mix for select days of some years of the plans that were modeled.

#### High Over-Generation Energy Profiles for 100% Renewables by 2020 Plan

Figure K-68 provides a view of the day in the year 2020 that has the highest amount of over-generation for 100% Renewable by 2020 Plan. On this day, there is over-generation in every hour of the day.

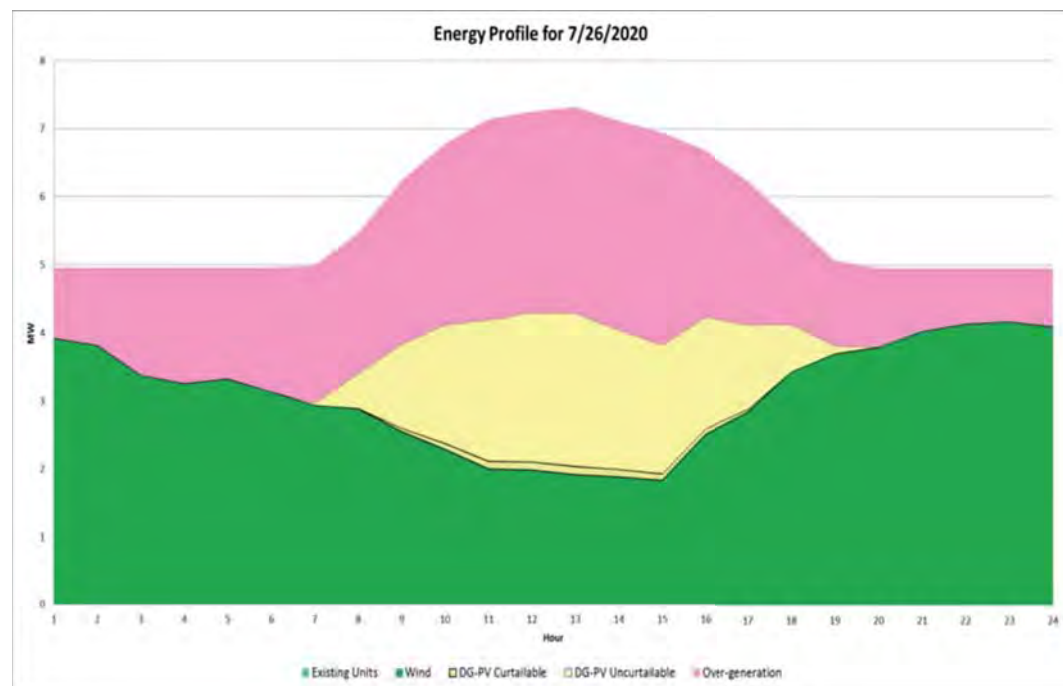

Figure K-68. 100% Renewables by 2020 Plan Moloka'i High Over-Generation Energy Profile: 2020

Figure K-69, Figure K-70, and Figure K-71 show high over-generation days in 2030, 2040, and 2045, respectively. Over-generation increasing over time is illustrated below..

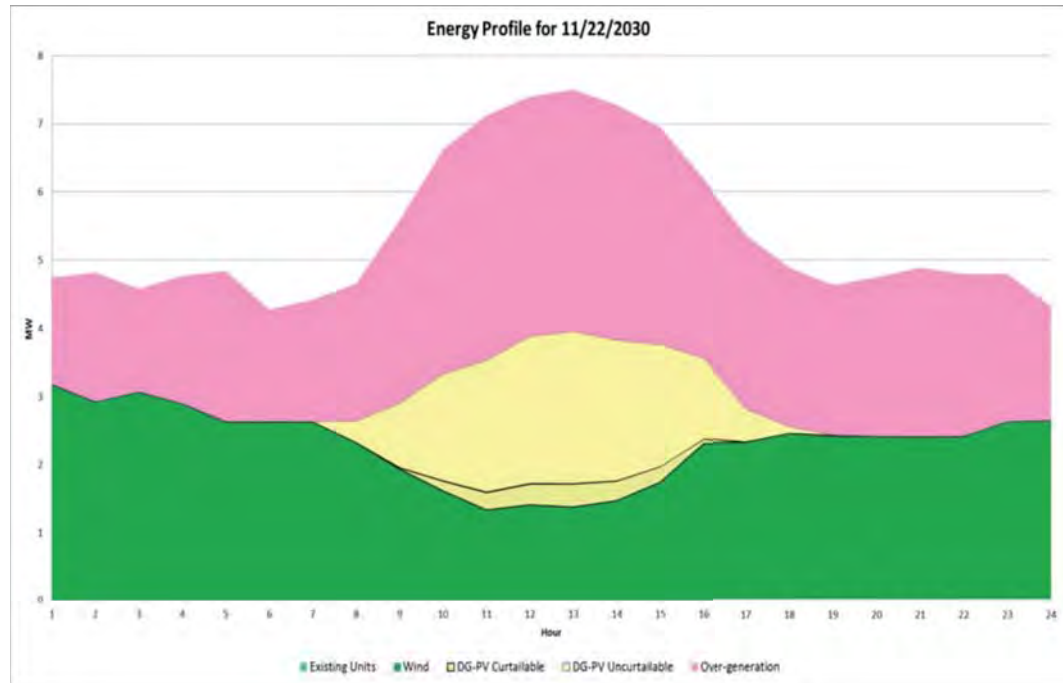

Figure K-69. 100% Renewables by 2020 Plan Moloka'i High Over-Generation Energy Profile: 2030

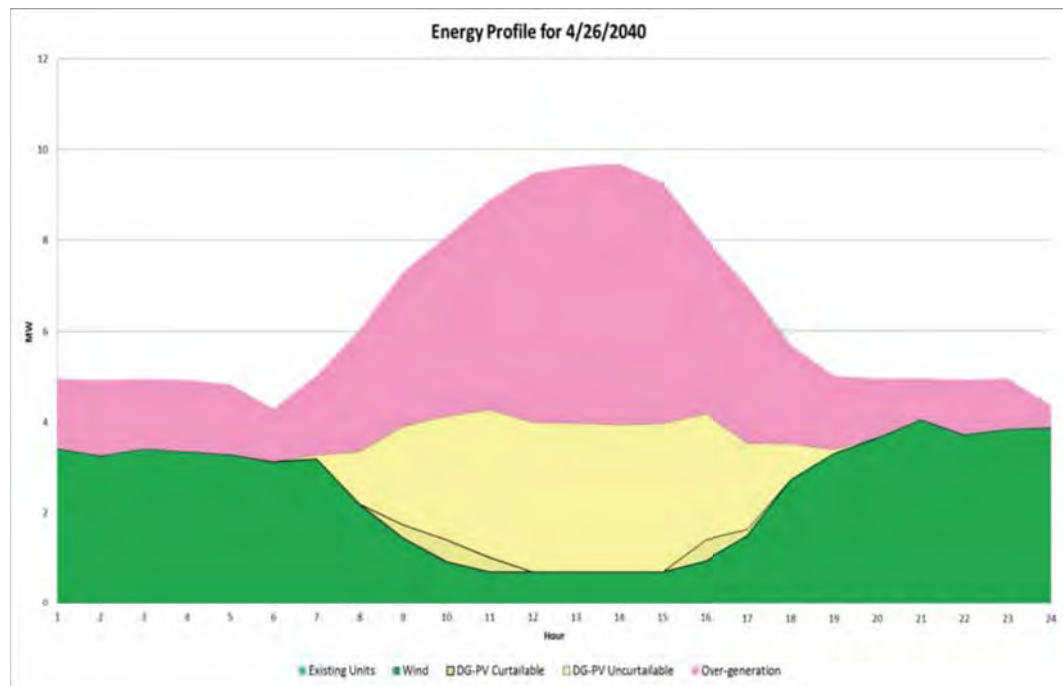

Figure K-70. 100% Renewables by 2020 Plan Moloka'i High Over-Generation Energy Profile: 2040



## K. Analytical Steps and Results

### Moloka'i Analytical Steps and Results

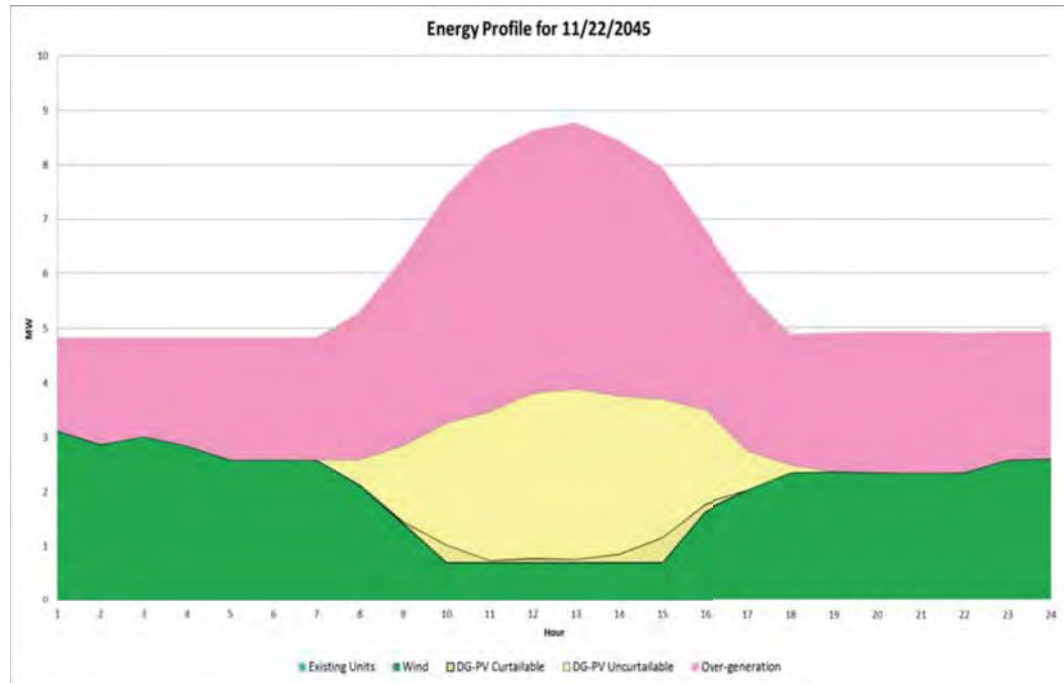

Figure K-71. 100% Renewables by 2020 Plan Moloka'i High Over-Generation Energy Profile: 2045

### Low Renewable Energy Profiles for 100% Renewables by 2020 Plan

Although Hawai'i has abundant renewable resources, such as wind and solar, there are days for which there is limited solar and/or limited or no wind available. Figure K-72, Figure K-73, Figure K-74, and Figure K-75 illustrate how different the energy profile is on days with low renewable energy available in the years 2020, 2030, 2040, and 2045, respectively, for the 100% Renewable by 2020 Plan. Even with the addition of 5 MW of grid-scale wind in 2020, on days where there is low wind availability, thermal generation is still necessary to serve the load.

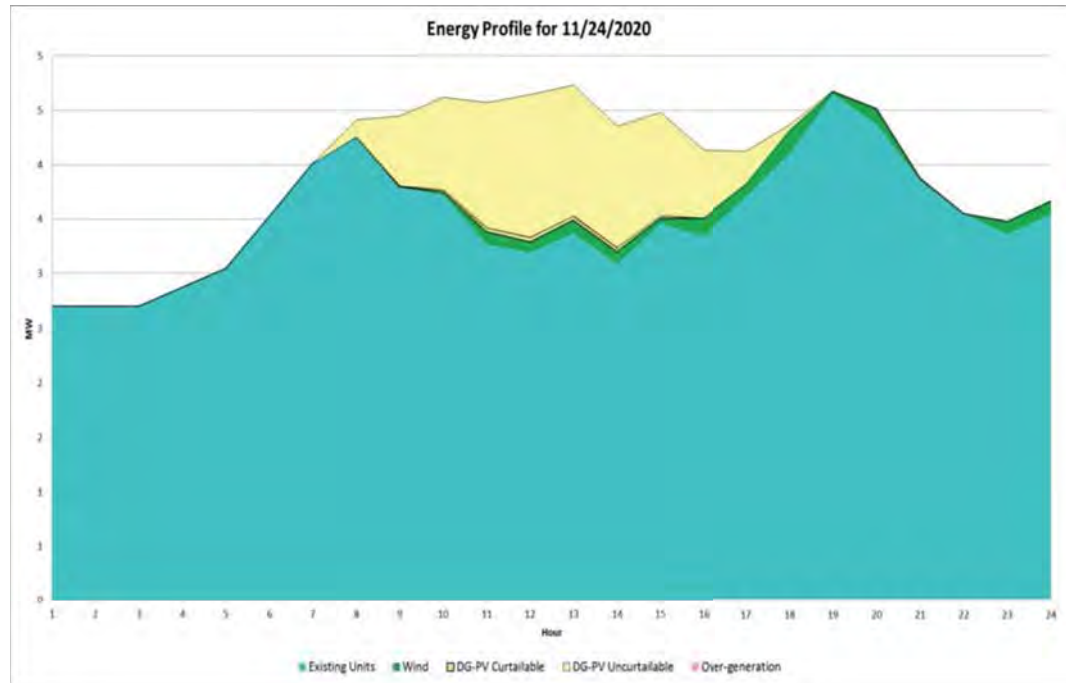

Figure K-72. 100% Renewables by 2020 Plan Moloka'i Low Renewables Energy Profile: 2020

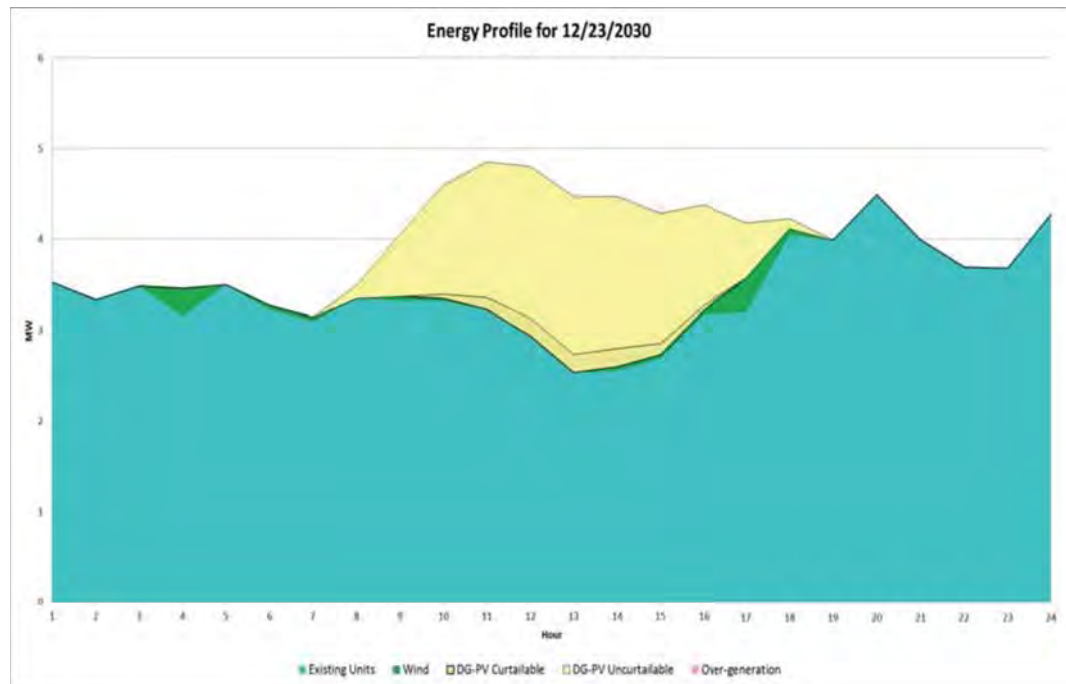

Figure K-73. 100% Renewables by 2020 Plan Moloka'i Low Renewables Energy Profile: 2030

## K. Analytical Steps and Results

### Moloka'i Analytical Steps and Results

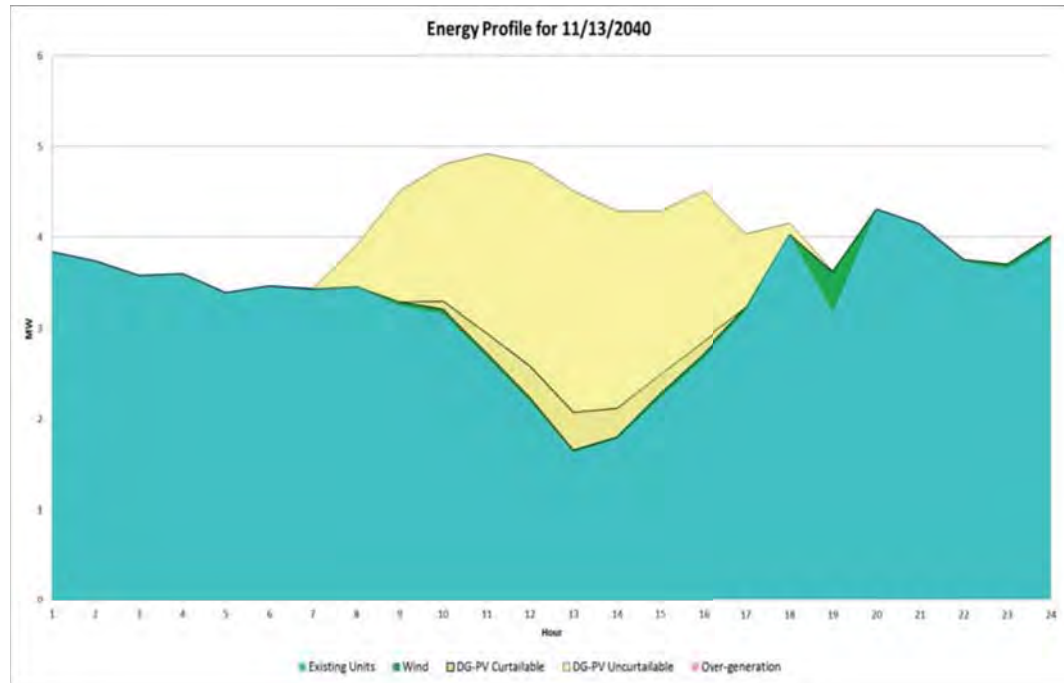

Figure K-74. 100% Renewables by 2020 Plan Moloka'i Low Renewables Energy Profile: 2040

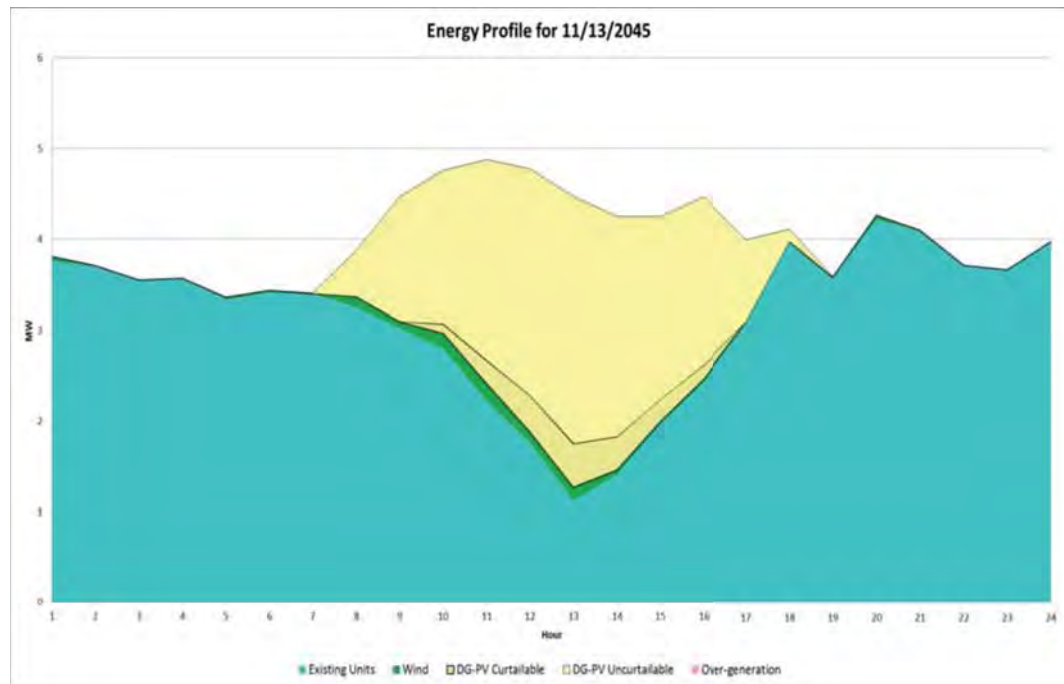

Figure K-75. 100% Renewables by 2020 Plan Moloka'i Low Renewables Energy Profile: 2045

### High Over-Generation Energy Profiles for 100% Renewables by 2030 Plan

The daily energy profiles for the 100% Renewable by 2030 Plan are identical to the daily energy profiles provided above for the 100% Renewable by 2020 case as the resource plans are identical.

### Low Renewable Energy Profiles for 100% Renewables by 2030 Plan

The daily energy profiles for the 100% Renewable by 2030 Plan are identical to the daily energy profiles provided above for the 100% Renewable by 2020 case as the resource plans are identical.

## K. Analytical Steps and Results

Lana'i Analytical Steps and Results

### LANA'I ANALYTICAL STEPS AND RESULTS

The core cases analyzed for Lana'i outline different paths to achieving 100% renewable energy in 2020 and 2030.

#### Energy Mix of Lana'i Plans

Figure K-76 summarizes the annual RPS for each year.

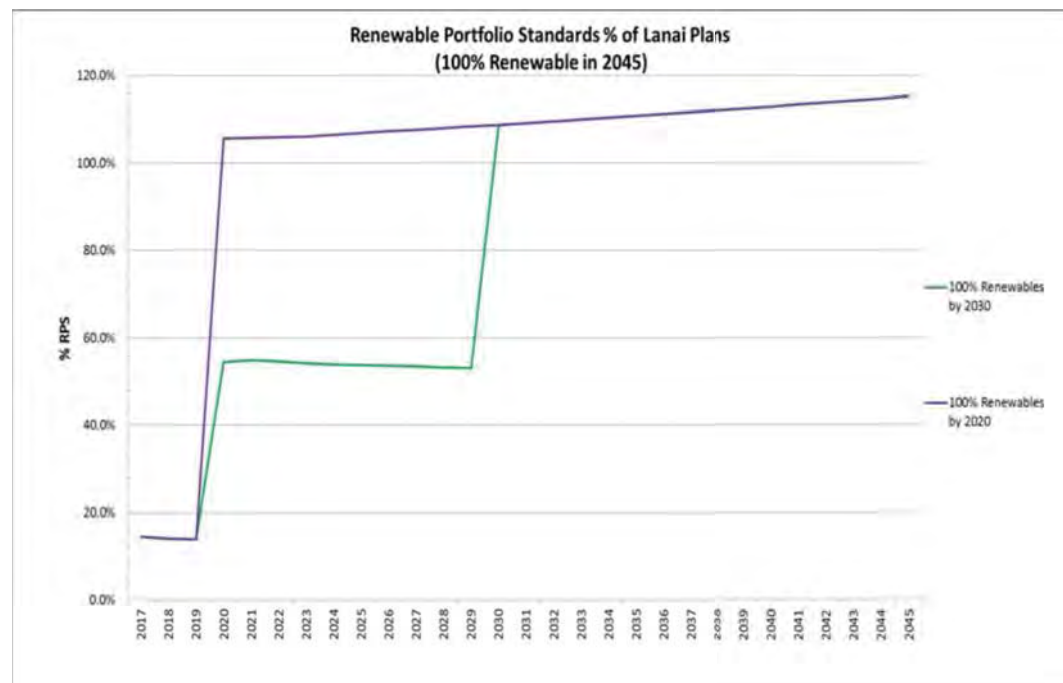

Figure K-76. Renewable Portfolio Standards Percent of Lana'i Plans

The calculation of the RPS per the law does result in values over 100%. Accelerated targets of 100% renewable energy by 2020 and 100% renewable energy by 2030 are shown in Figure K-77, which includes renewable energy as a percent of total energy including customer-sited generation.

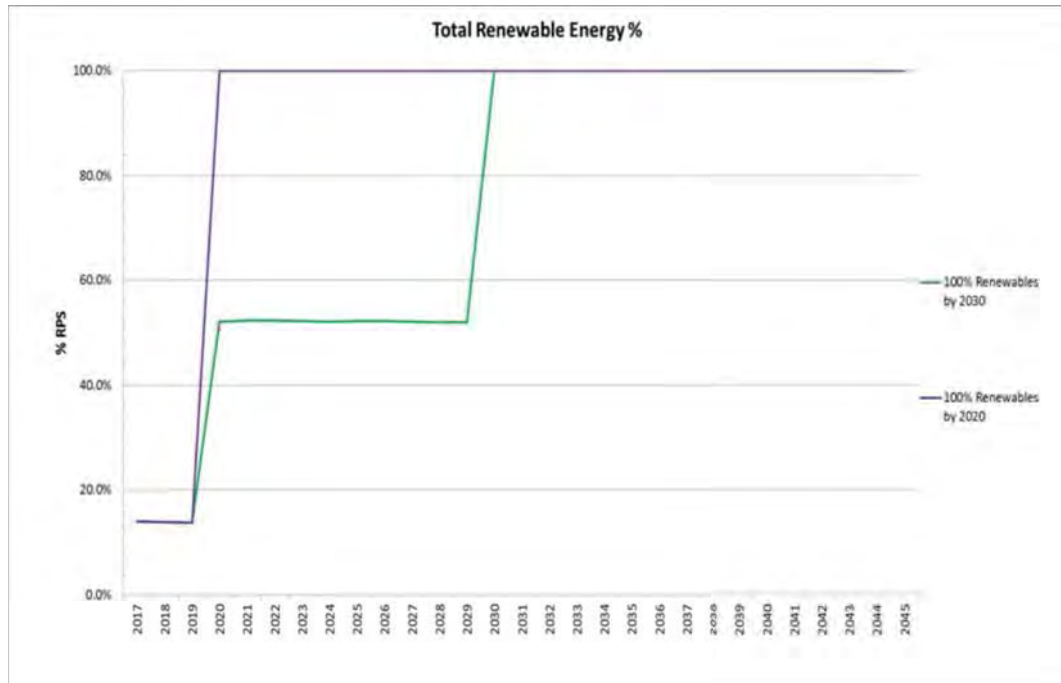

Figure K-77. Total Renewable Energy Percent of Lana'i Plans

The resource mix for the plans changes over time as it reaches 100% renewable. The figures below reveal how the energy mix in each plan grows to 100% renewable energy.

The annual energy served by resource type is shown in Figure K-78 for the 100% Renewables by 2020 Plan. Although the addition of grid-scale wind in the year 2020 provides a significant amount of energy, there is still a significant amount of biofuel utilized to achieve 100% renewable energy.

## K. Analytical Steps and Results

### Lana'i Analytical Steps and Results

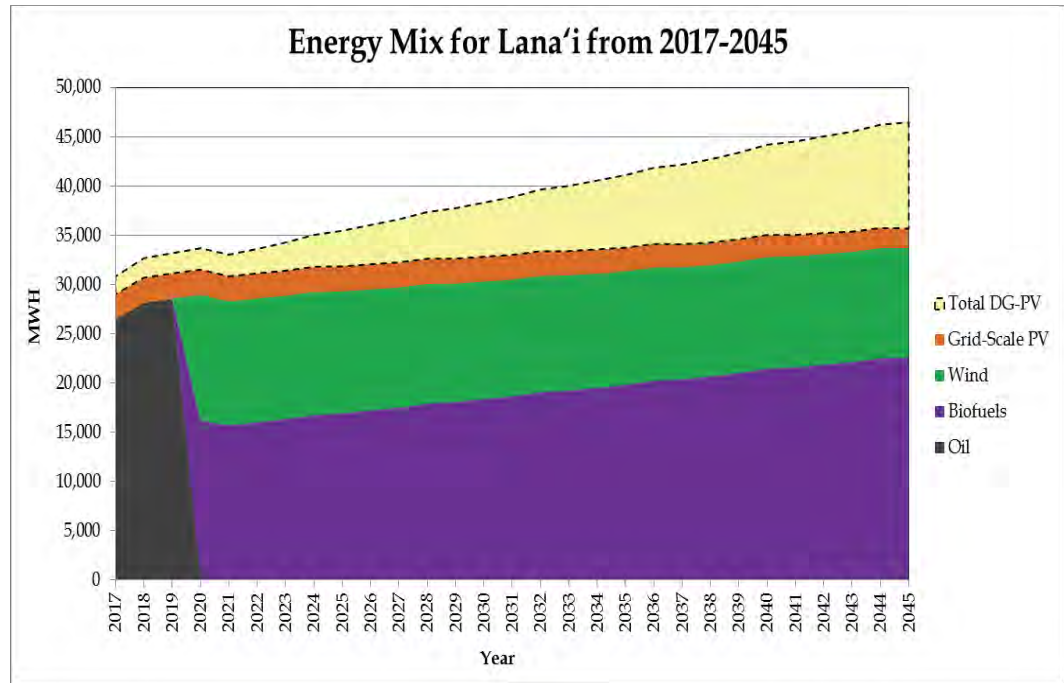

Figure K-78. Energy Mix for 100% Renewables by 2020 Plan on Lana'i

Figure K-79 shows the energy mix of the 100% Renewables by 2030 Plan.

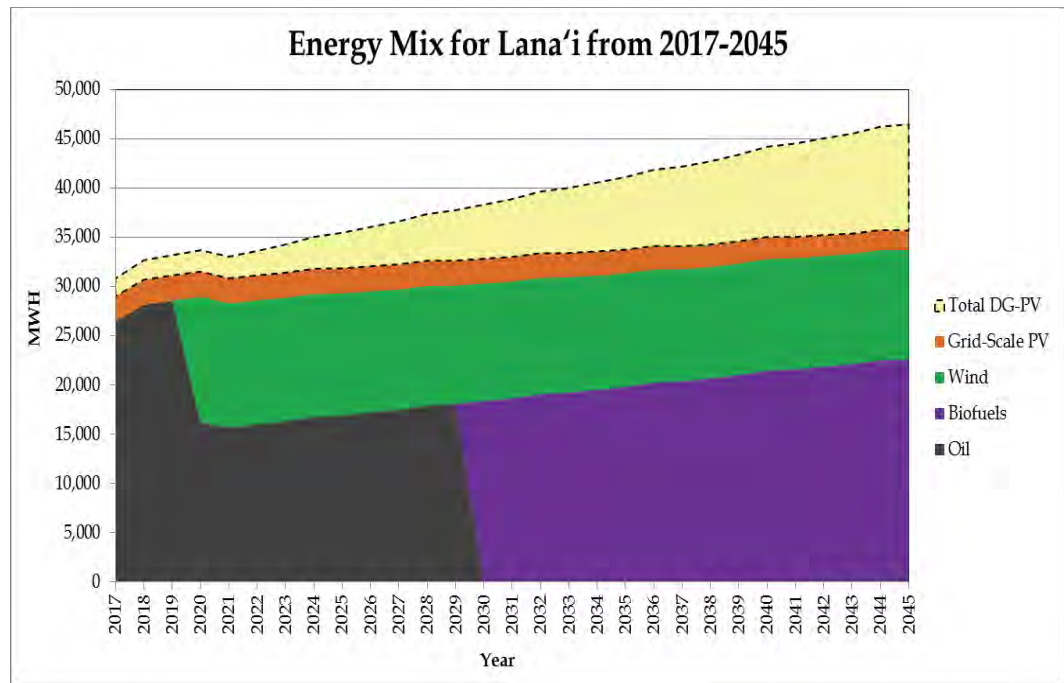

Figure K-79. Energy Mix for 100% Renewables by 2030 Plan on Lana'i

### Percent Over-Generation of Total System for Lana'i Plans

As increasingly more renewable energy is added to the system, over-generation occurrences will become inevitable. Figure K-80 provides estimates of the percent over-generation of the total system annual energy for the 100% Renewable by 2020 and 100% Renewable by 2030 plans. Both cases add 4 MW of grid-scale wind in 2020 at which time over-generation significantly increases. Both plans have similar annual over-generation since the resource plans are identical. Situations of over-generation provide opportunities, coupled with appropriate controls systems, to allow wind and solar generation to contribute to regulation up resources in addition to use as a reserve resource. This provides improved system performance. In combination, wind and solar used for energy and some level of regulation and reserve appears to be cheaper than the alternative of additional storage, at least at moderate over-generation levels. For the purposes of this December 2016 PSIP update (similar to the April 2016 PSIP update), we include the full cost of the grid-scale wind and solar resources in cost calculations, regardless of over-generation levels and provide a simplified accounting for other services from these resources.

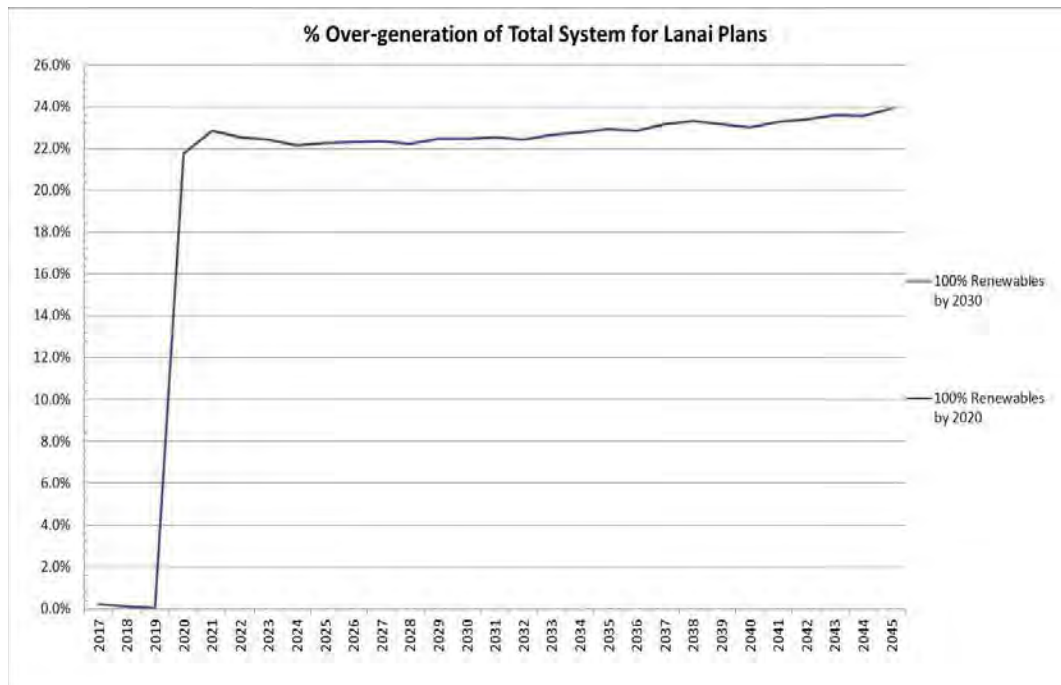

Figure K-80. Total System Over-Generation Percent for Lana'i Plans

### Unserved Energy of Lana'i Plans

While periods of over-supply exist as described above, periods of unserved energy can also occur. The plans evaluate whether sufficient generation to serve load exists with variable renewable energy and minimal conventional thermal resources on the system. If



## K. Analytical Steps and Results

### Lana'i Analytical Steps and Results

there was sufficient generation being provided by the remaining thermal resources, variable renewable resources, and storage, then there would not be any unserved energy. The year-by-year amount of unserved energy in hours and energy for the 100% Renewable by 2020 Plan is shown in Figure K-81. For example, in 2020, there are approximately 3.8 kWh total of unserved energy that occurs over the course of two hours in that year.

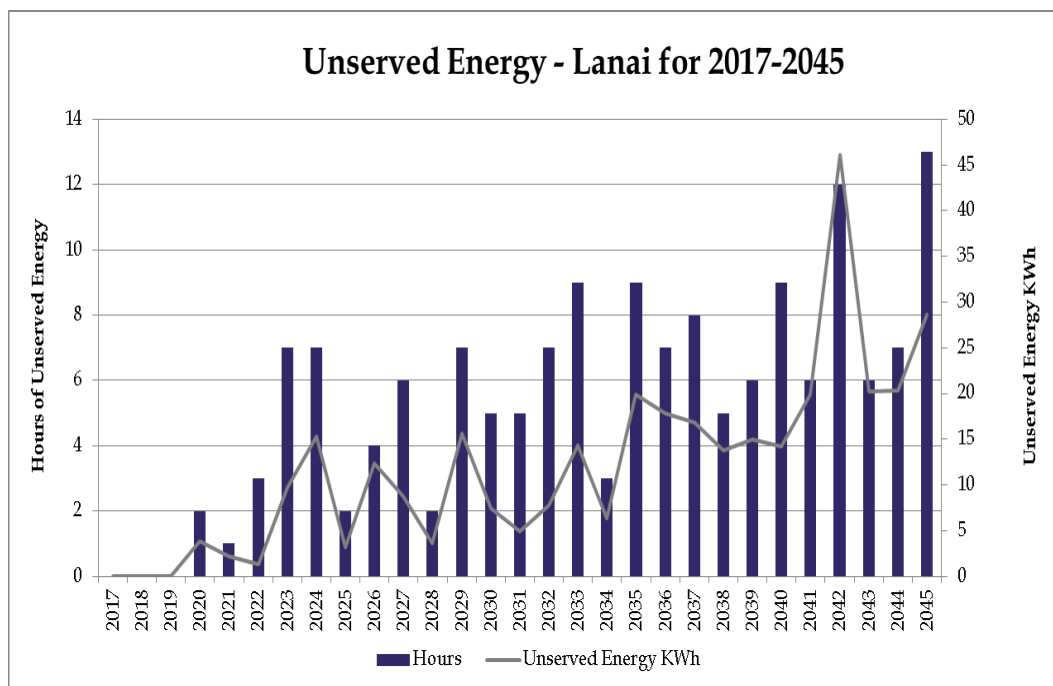

Figure K-81. Unserved Energy for 100% Renewables by 2020 Plan on Lana'i

The unserved energy for the 100% Renewable by 2030 Plan is similar to the 100% Renewable by 2020 Plan since the resource plans are identical.

## Seasonal Variations of Lana'i Renewable Energy

The resource plans optimized using the PLEXOS model include considerable amounts of grid-scale wind, 4 MW, in 2020 for both the 100% Renewable by 2020 and 100% Renewable by 2030 plans. The seasonality of available grid-scale wind is shown in the figures below.

Figure K-82 shows the difference between the load and the available renewable energy in the year 2025. The difference must be met with thermal generation to prevent unserved energy.

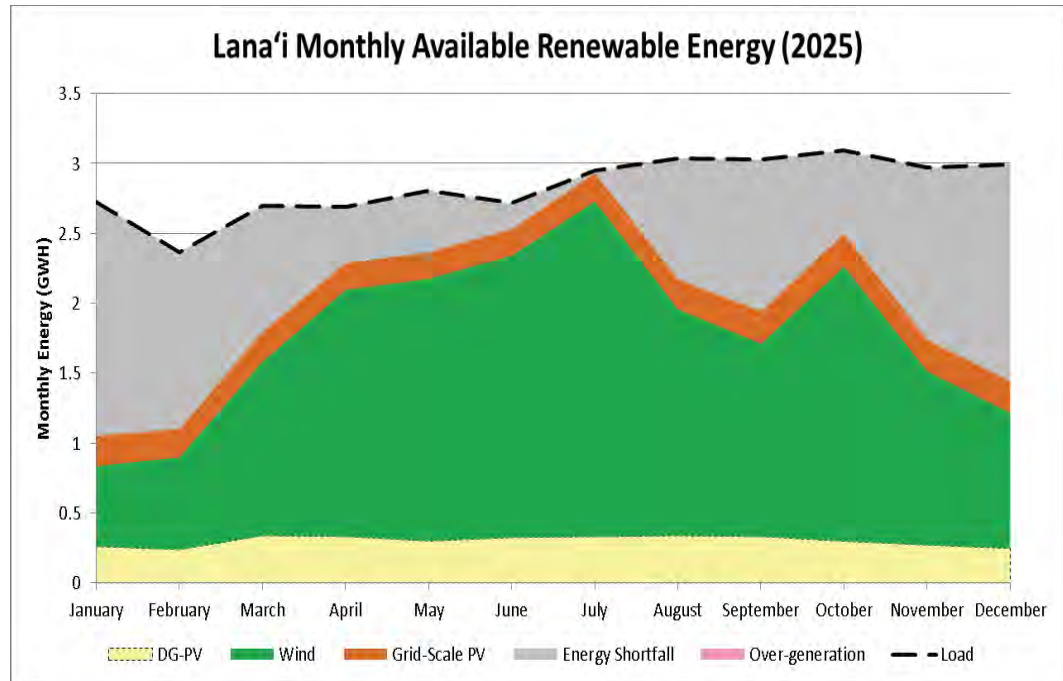

Figure K-82. 100% Renewable by 2020 Plan Monthly Available Renewable Energy vs Load on Lana'i in 2025

Figure K-83 shows the difference between the load and the available renewable energy in the year 2045. Despite having high amounts of renewable energy available in some months, creating a surplus, shown in pink, there are some months for which there is a deficit, shown in gray. This highlights the continued need for thermal generators to provide supplemental generation during these shortfall periods or energy storage systems, which are capable of shifting energy over several months from the months where there is a surplus to the months where there are shortfall.

## K. Analytical Steps and Results

### Lana'i Analytical Steps and Results

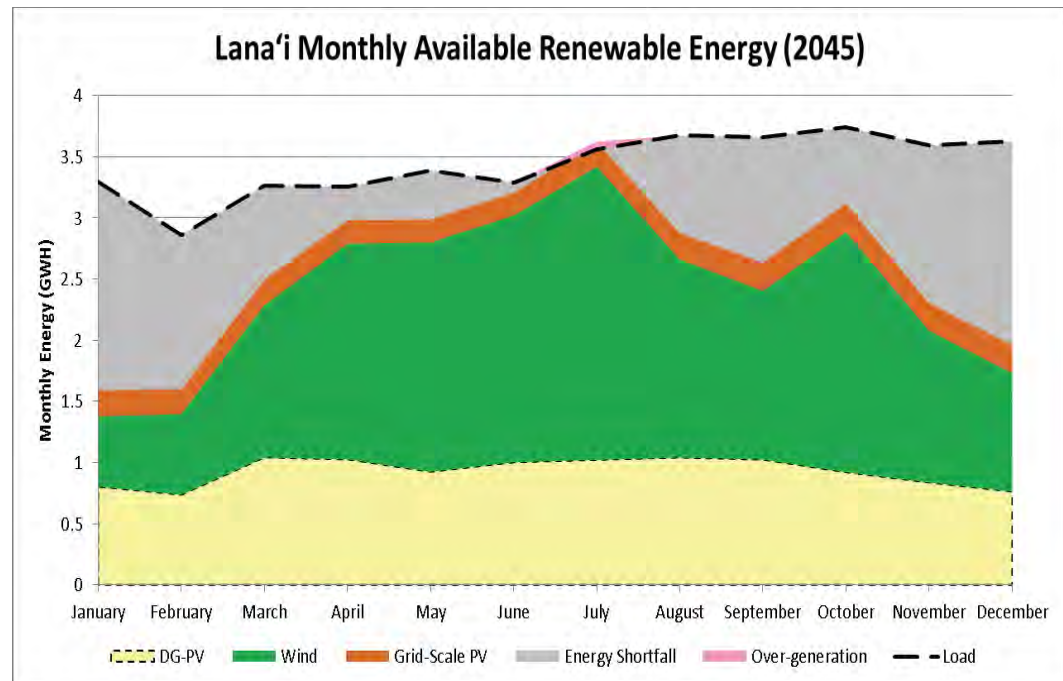

Figure K-83. 100% Renewable by 2020 Plan Monthly Available Renewable Energy vs Load on Lana'i in 2045

### Sub-Hourly Charts of Lana'i Plans

Sub-hourly modeling was performed to analyze the impact that variable renewable energy would have on our system, and whether our portfolio of generators and storage systems would be sufficient to stabilize the electrical grid.

Due to limited data available on Lana'i, historical minutely renewable energy data from Maui was used to determine the volatility of solar and wind resources on Lana'i. Historical minutely load data from Lana'i was also used. The volatility of the Auwahi wind farm was applied to future grid-scale wind resources.

An initial screening was done to determine the month with the largest potential minutely downward ramp. PLEXOS was then employed to perform a stochastic analysis on this month. Using the historical minutely data, stochastic variables were created for all as-available resources and the load.

There was virtually no unserved energy in the sub-hourly analysis for Lana'i in both the 100% Renewable by 2020 and 100% Renewable by 2030 cases when a 1-, 15-, and 30-minute look-ahead was assumed. However, as described in Chapter 4, no regulation requirements were included for the Lana'i PLEXOS modeling, thus further analysis is needed to determine whether there are sufficient resources to integrate high levels of variable renewable generation on Lana'i. It should be noted that in actual operations no perfect look ahead is possible, regardless of the time duration

## Daily Energy Charts of Lana'i Plans

The charts in the previous sections displayed annual and monthly views of how renewable energy is being integrated into the plans and the impacts to the system energy production. This section will convey a more granular view by providing the energy mix for select days of some years of the plans that were modeled.

### High Over-Generation Energy Profiles for 100% Renewables by 2020 Plan

Figure K-84 provides a view of the day in the year 2020 that has the highest amount of over-generation for 100% Renewable by 2020 Plan. On this day, there is over-generation in every hour of the day.

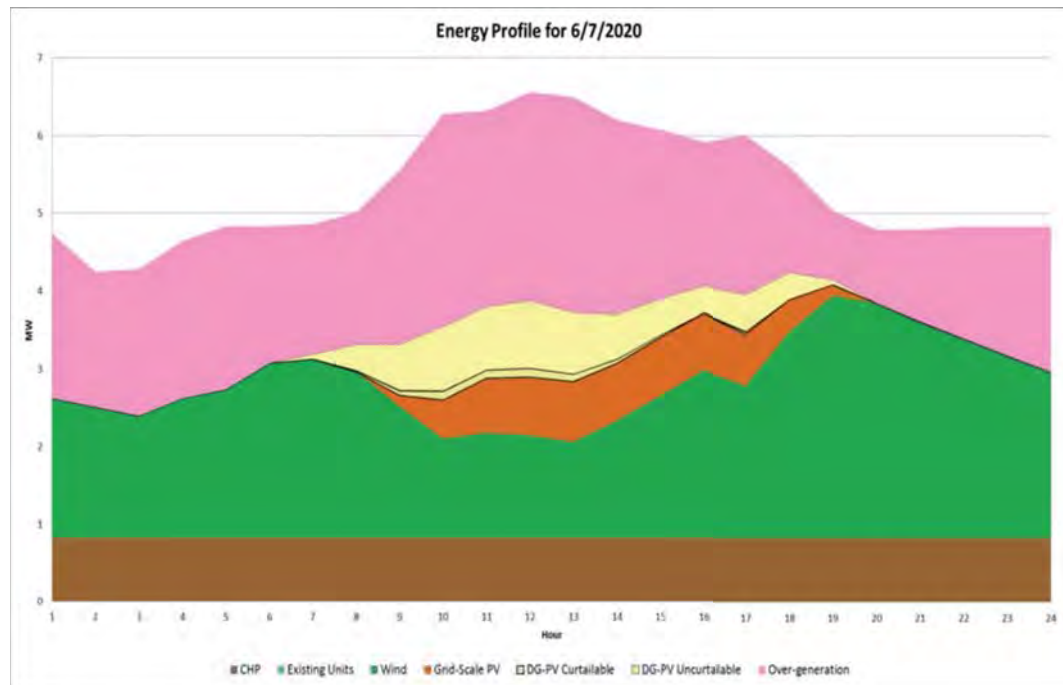

Figure K-84. 100% Renewables by 2020 Plan Lana'i High Over-Generation Energy Profile: 2020

Figure K-85, Figure K-86, and Figure K-87 show high over-generation days in 2030, 2040, and 2045, respectively. Over-generation increasing over time is illustrated below.

## K. Analytical Steps and Results

### Lana'i Analytical Steps and Results

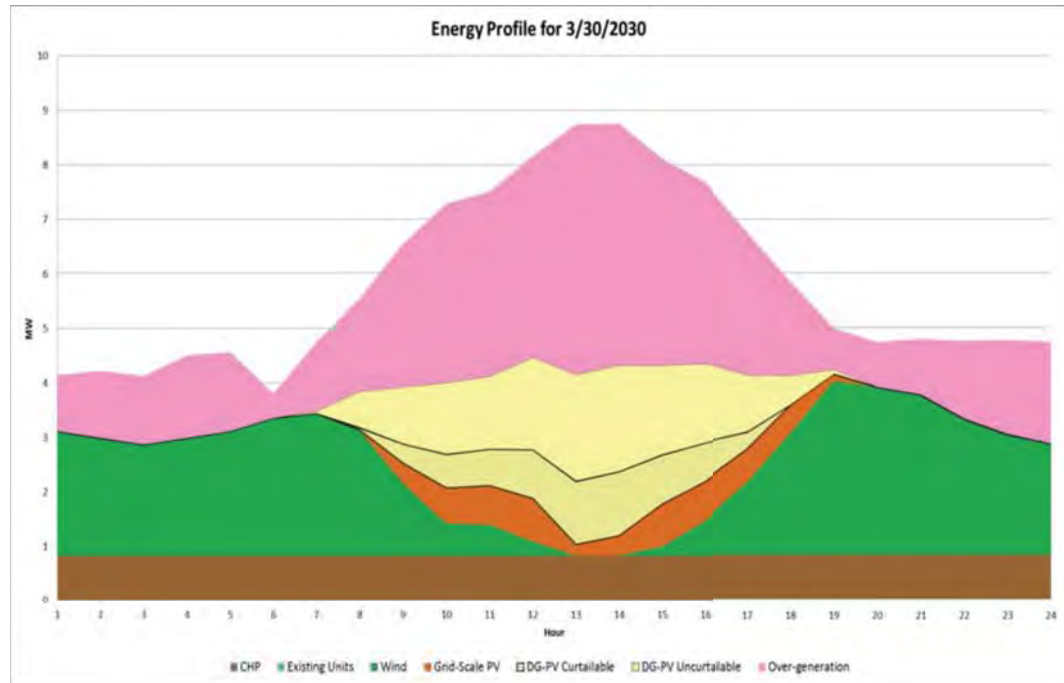

Figure K-85. 100% Renewables by 2020 Plan Lana'i High Over-Generation Energy Profile: 2030

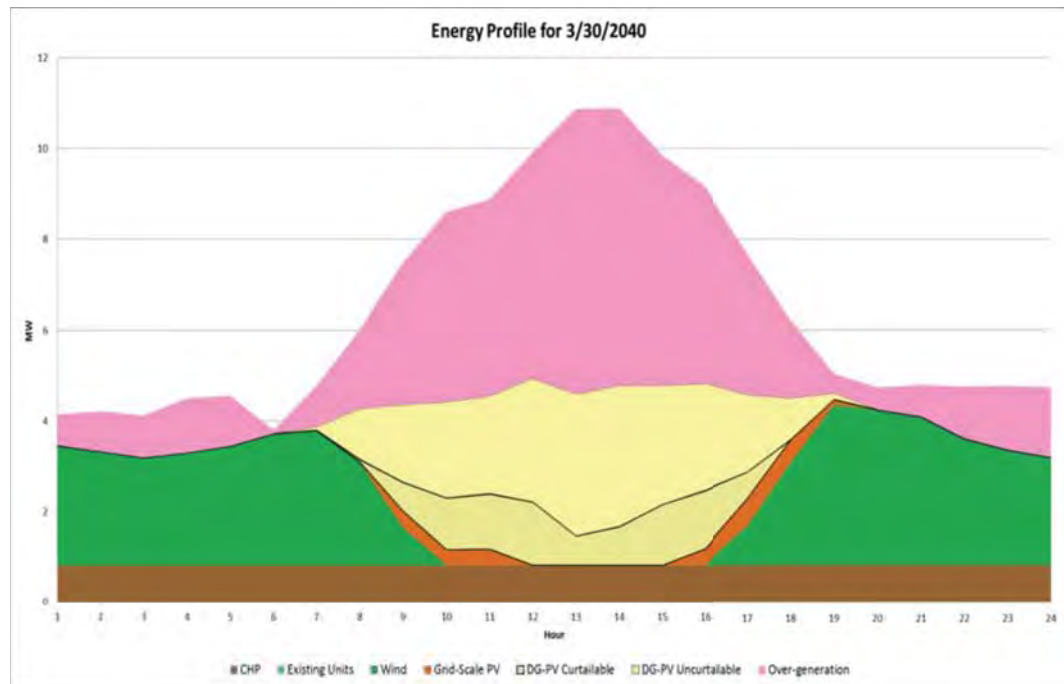

Figure K-86. 100% Renewables by 2020 Plan Lana'i High Over-Generation Energy Profile: 2040

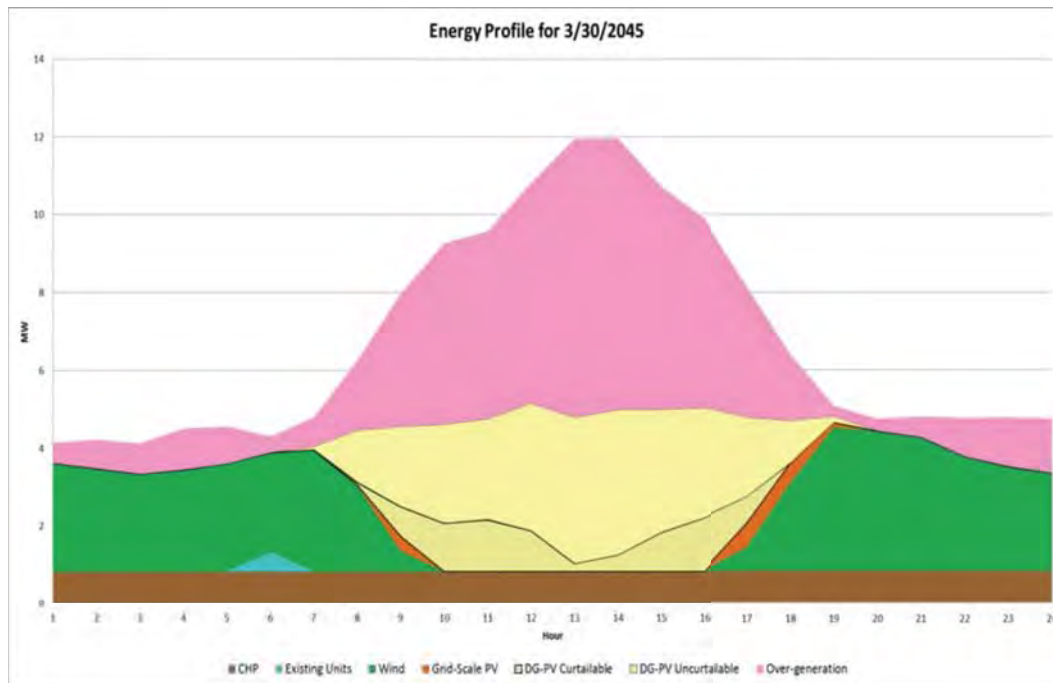

Figure K-87. 100% Renewables by 2020 Plan Lana'i High Over-Generation Energy Profile: 2045

### Low Renewable Energy Profiles for 100% Renewables by 2020 Plan

Although Hawai'i has abundant renewable resources, such as wind and solar, there are days for which there is limited solar and/or limited or no wind available. Figure K-88, Figure K-89, Figure K-90, and Figure K-91 illustrate how different the energy profile is on days with low renewable energy available in the years 2020, 2030, 2040, and 2045, respectively, for the 100% Renewable by 2020 Plan. Even with the addition of 4 MW of grid-scale wind in 2020, on days where there is low wind availability, thermal generation is still necessary to serve the load.

## K. Analytical Steps and Results

### Lana'i Analytical Steps and Results

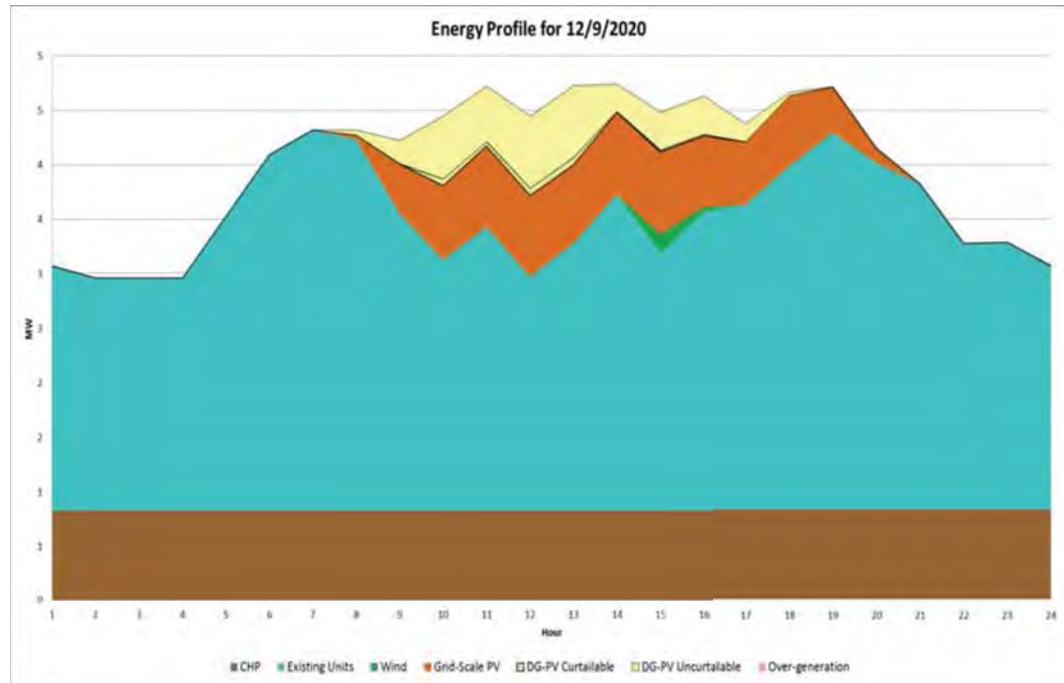

Figure K-88. 100% Renewables by 2020 Plan Lana'i Low Renewables Energy Profile: 2020

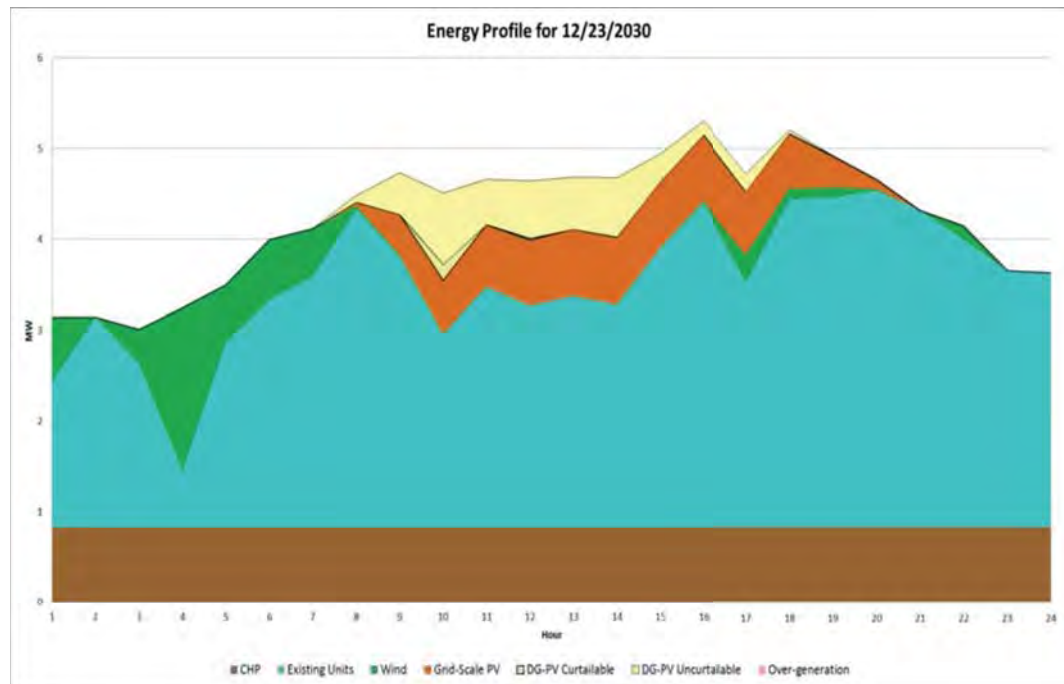

Figure K-89. 100% Renewables by 2020 Plan Lana'i Low Renewables Energy Profile: 2030

**K. Analytical Steps and Results**

Lana'i Analytical Steps and Results

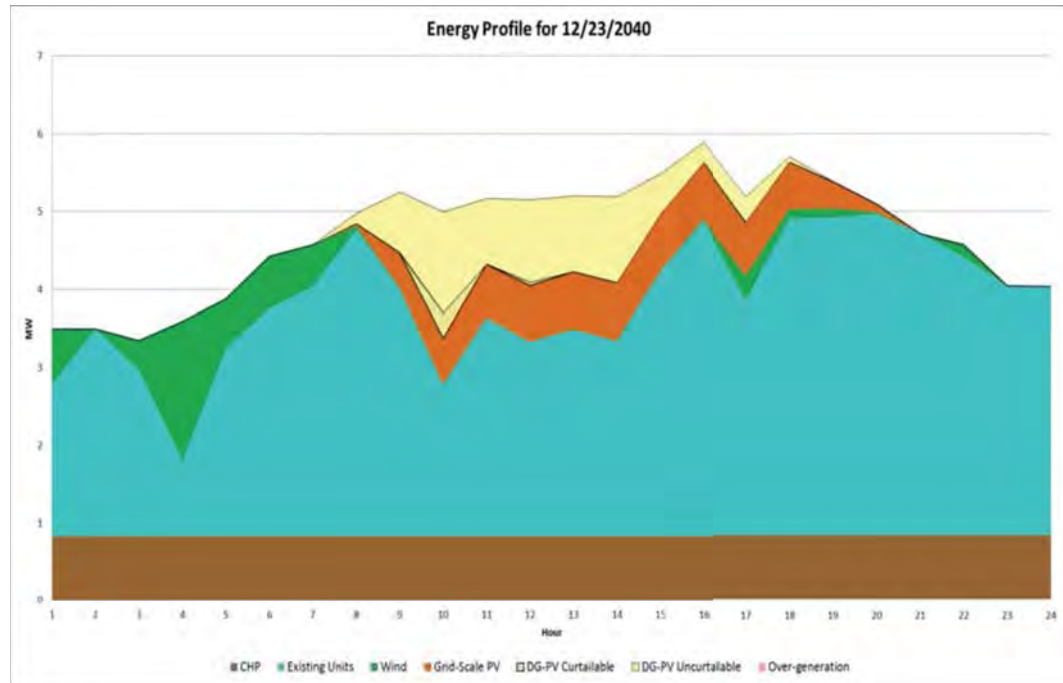

Figure K-90. 100% Renewables by 2020 Plan Lana'i Low Renewables Energy Profile: 2040

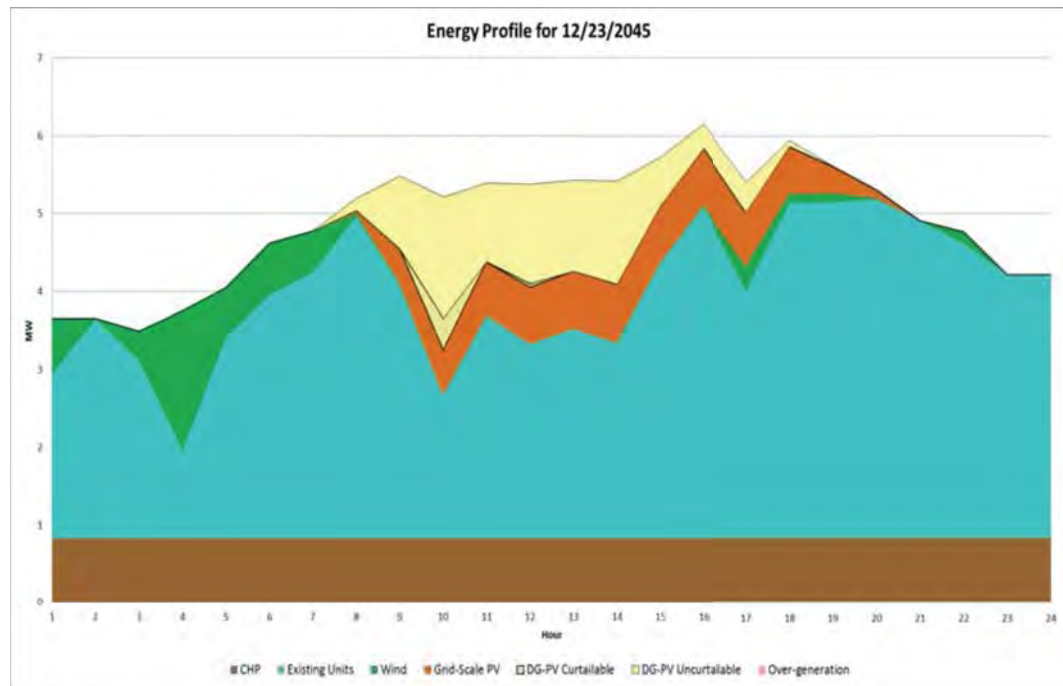

Figure K-91. 100% Renewables by 2020 Plan Lana'i Low Renewables Energy Profile: 2045



## **K. Analytical Steps and Results**

### Lana'i Analytical Steps and Results

#### **High Over-Generation Energy Profiles for 100% Renewables by 2030 Plan**

The daily energy profiles for the 100% Renewable by 2030 Plan are identical to the daily energy profiles provided above for the 100% Renewable by 2020 case as the resource plans are identical.

#### **Low Renewable Energy Profiles for 100% Renewables by 2030 Plan**

The daily energy profiles for the 100% Renewable by 2030 Plan are identical to the daily energy profiles provided above for the 100% Renewable by 2020 case as the resource plans are identical.

## HAWAI'I ISLAND ANALYTICAL STEPS AND RESULTS

The core cases analyzed for Hawai'i Island outline different paths to achieving 100% renewable energy in 2045 as well as an accelerated target of 2040 consistent with the April 2016 PSIP.

### Energy Mix of Hawai'i Island Plans

Figure K-92 summarizes the annual RPS for each year.

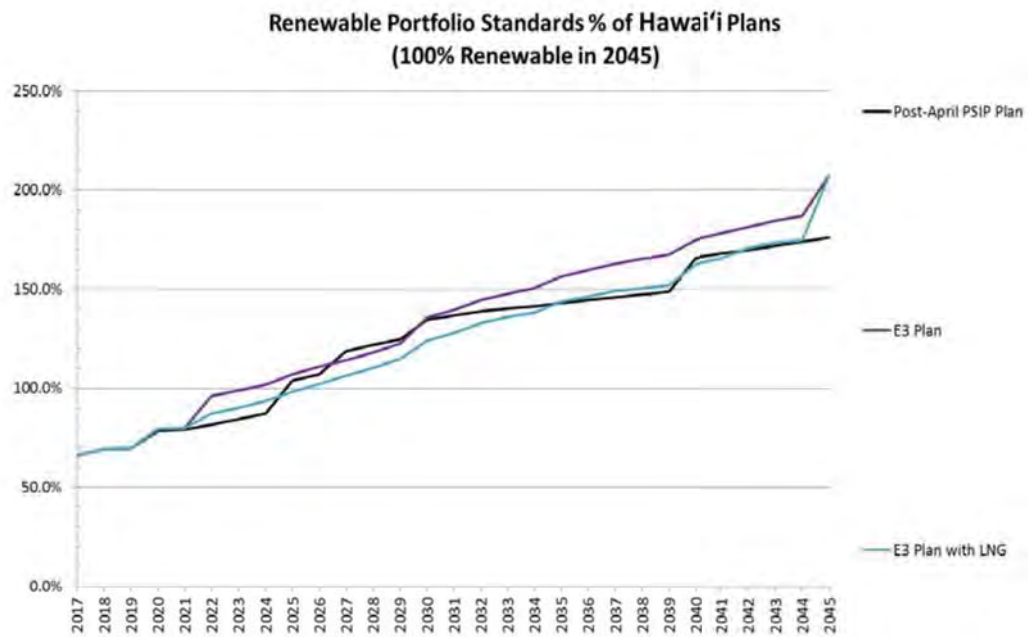

Figure K-92. Renewable Portfolio Standards Percent of Hawai'i Island Plans

The calculation of the RPS per the law does result in values over 100%. To emphasize that we are committed to achieving 100% renewable energy in 2045, Figure K-93 shows the renewable energy as a percent of total energy including customer-sited generation.

## K. Analytical Steps and Results

### Hawai'i Island Analytical Steps and Results

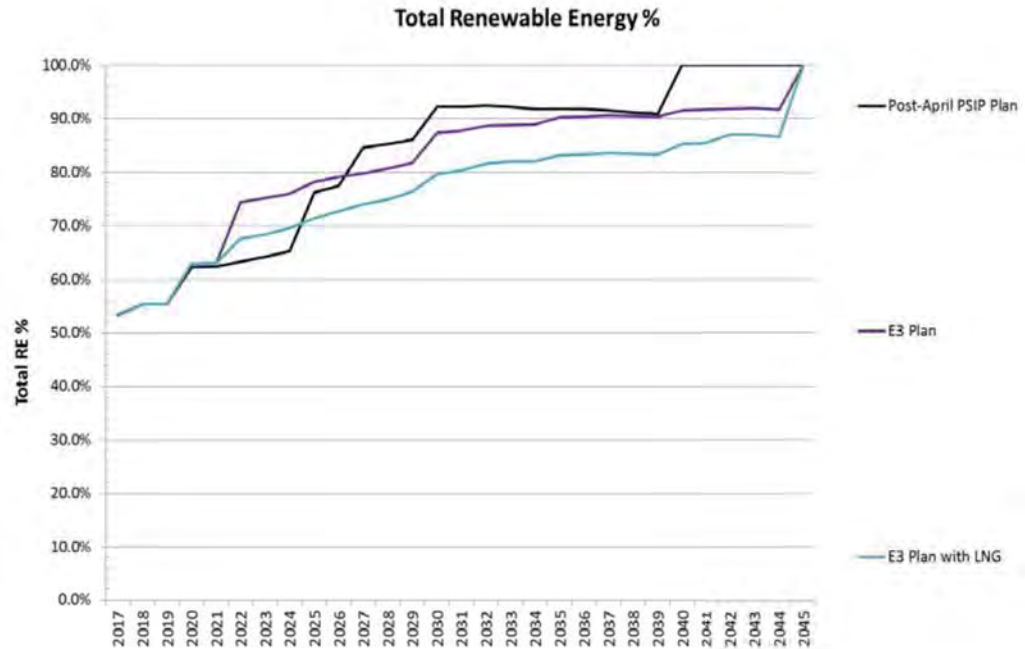

Figure K-93. Total Renewable Energy Percent of Hawai'i Island Plans

The resource mix for the plans changes over time as it reaches 100% renewable in 2045 for the E3 plans and 100% renewable in 2040 for the Post-April PSIP Plan.

The annual energy served by resource type is shown in Figure K-94 for the Post-April PSIP Plan. The transition to renewable wind and solar can be easily seen as the fossil fuel (oil) significantly decreases over time.

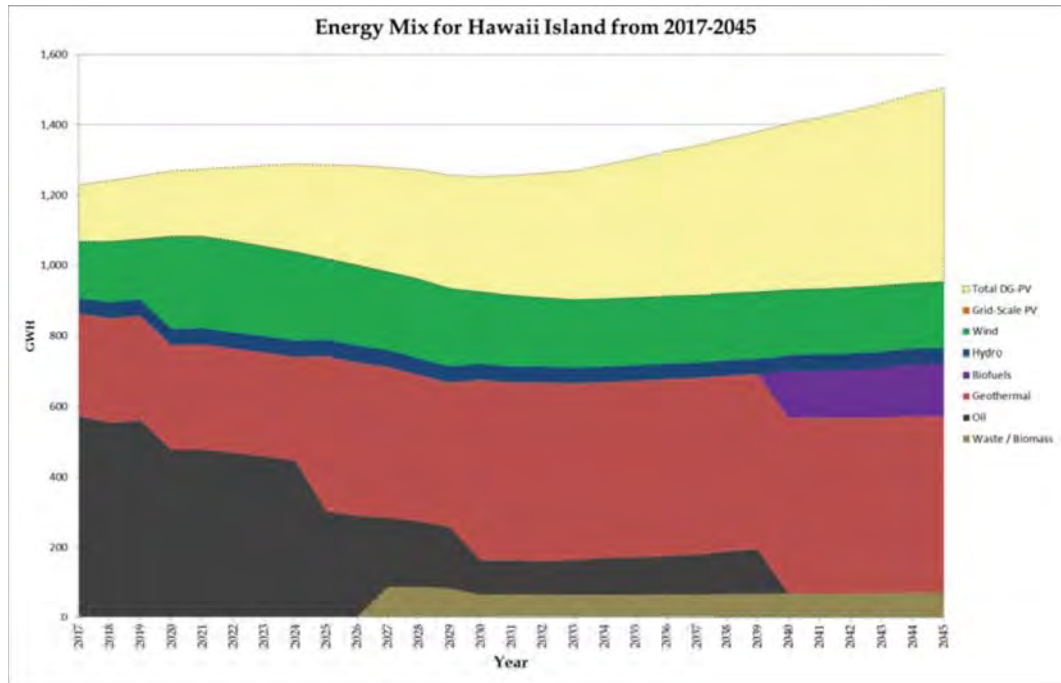

Figure K-94. Energy Mix for Post-April PSIP Plan on Hawai'i Island

Figure K-95 shows the energy mix of the E3 Plan.

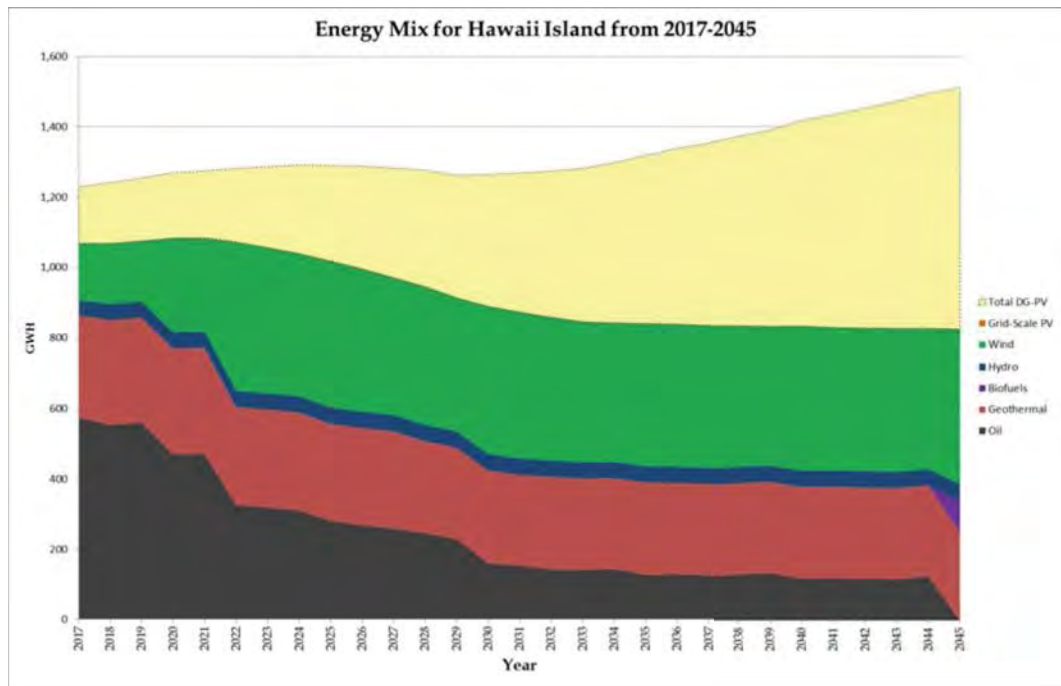

Figure K-95. Energy Mix for E3 Plan on Hawai'i Island

The E3 Plan with LNG uses LNG as a transitional fuel from oil. Renewable energy is added economically to meet intermediate RPS targets and ultimately 100% renewable energy in 2045. The energy mix for E3 Plan with LNG is shown in Figure K-96. The

## K. Analytical Steps and Results

### Hawai'i Island Analytical Steps and Results

transition to LNG assumes a contract period of 2022–2041. During the last intervening years in the transition to 100% renewable energy, potential future resources at this time could include biofuels, LNG, oil, other renewable options or a mix of options. Given rapidly evolving energy options and technology, the exact fuel mix is difficult to predict today.

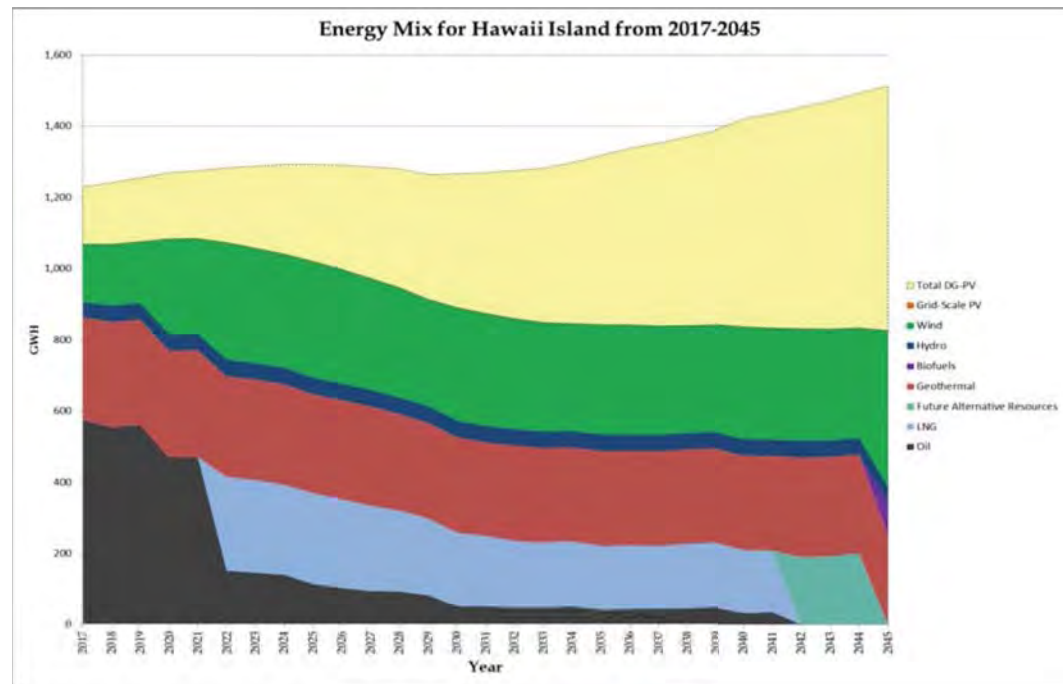

Figure K-96. Energy Mix for E3 Plan with LNG on Hawai'i Island

## Percent Over-Generation of Total System for Hawai'i Island Plans

As increasingly more renewable energy is added to the system, over-generation occurrences will become inevitable. Figure K-97 provides estimates of the percent over-generation of the total system annual energy for the various plans. Since the E3 Plan integrates greater amounts of grid-scale wind and earlier than the Post-April PSIP Plan, the percent over-generation increases significantly in the 2022 timeframe compared to the Post-April Plan. Load-shifting storage was not included in the Post-April PSIP Plan, but was included in the E3 plans, resulting in lower over-generation in the E3 plans overall when compared to the Post-April PSIP Plan. Although the E3 plans add load-shifting storage, situations of over-generation provide opportunities, coupled with appropriate controls systems, to allow wind and solar generation to contribute to regulation up resources in addition to use as a reserve resource. This provides improved system performance. In combination, wind and solar used for energy and some level of regulation and reserve appears to be cheaper than the alternative of additional storage, at least at moderate over-generation levels. For the purposes of this December 2016 PSIP

update (similar to the April 2016 PSIP update), we include the full cost of the grid-scale wind and grid-scale PV resources in cost calculations, regardless of over-generation levels and provide a simplified accounting for other services from these resources.

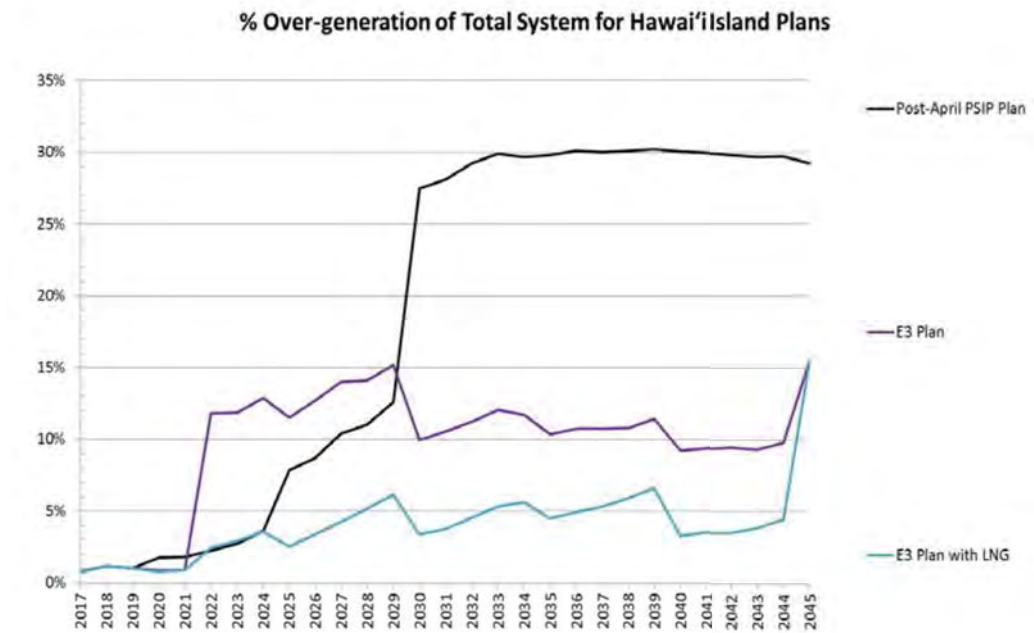

Figure K-97. Total System Over-Generation Percent for Hawai'i Island Plans

### Unserviced Energy of Hawai'i Island Plans

While periods of over-supply exist as described above, periods of unserved energy can also occur. The plans evaluate whether sufficient generation to serve load exists with variable renewable energy and storage with minimal conventional thermal resources on the system. The E3 plans identified existing conventional thermal generating units that could be considered for removal from service as an economic option. For the PLEXOS modeling of the E3 plans, these units were made unavailable to serve load or “offline”. If there was sufficient generation being provided by the remaining thermal resources, variable renewable resources, and storage, then there would not be any unserved energy. The year-by-year amount of unserved energy in hours and energy for the E3 Plan is shown in Figure K-98. For example, in 2020, there is approximately 31 MWh total of unserved energy which occurs over the course of 4 hours in the year.

## K. Analytical Steps and Results

### Hawai'i Island Analytical Steps and Results

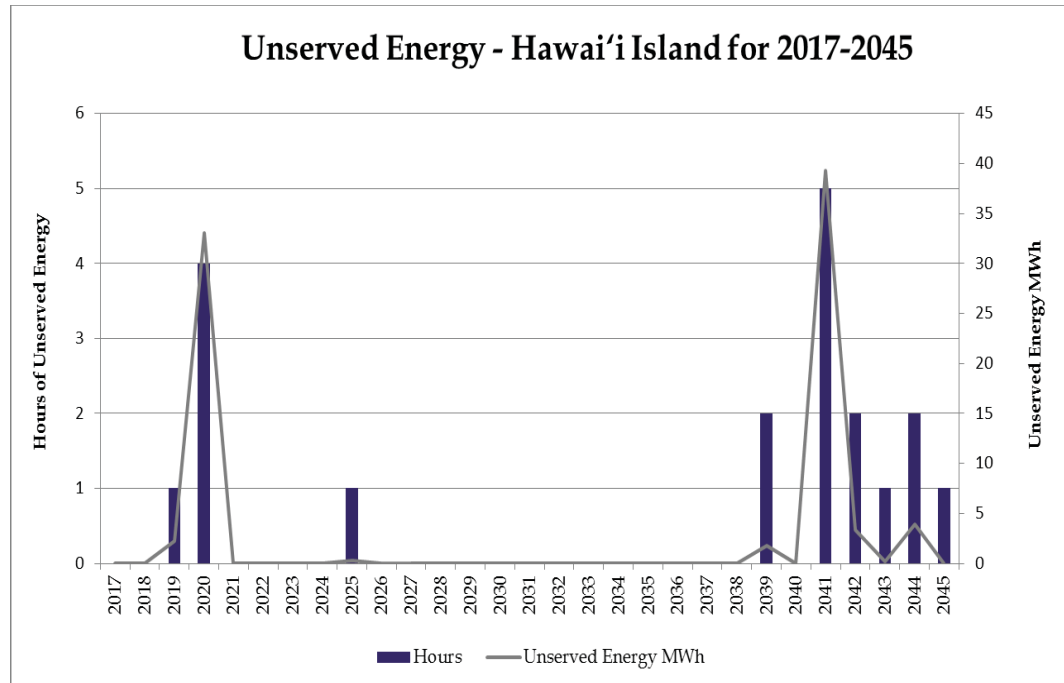

Figure K-98. Unservd Energy for E3 Plan on Hawai'i Island

Figure K-99 indicates that the Post-April PSIP Plan has about one hour of unserved energy in 2019 and does not have unserved energy until the 2038 timeframe.. The few hours of unserved energy could be investigated in more detail and may be due to thermal generating units being on maintenance which could be adjusted or refined as we approach the year of concern.

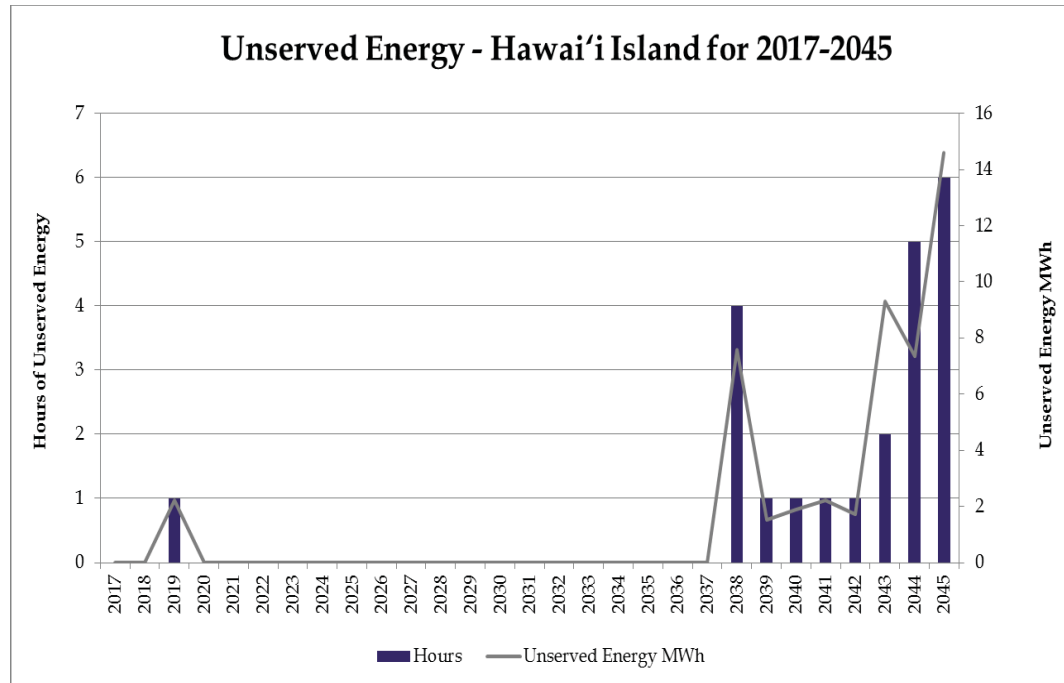

Figure K-99. Unserved Energy for Post-April PSIP Plan on Hawai'i Island

### Seasonal Variations of Hawai'i Island Renewable Energy

While Hawai'i Island has firm renewable generation that is more predictably available, there is still a significant amount of variable renewable generation. Although there are diverse locations of resources, there can be periods with low production.

Figure K-100 shows the difference between the load and the available renewable energy in the year 2025. The difference must be met with thermal generation to prevent unserved energy.



## K. Analytical Steps and Results

### Hawai'i Island Analytical Steps and Results

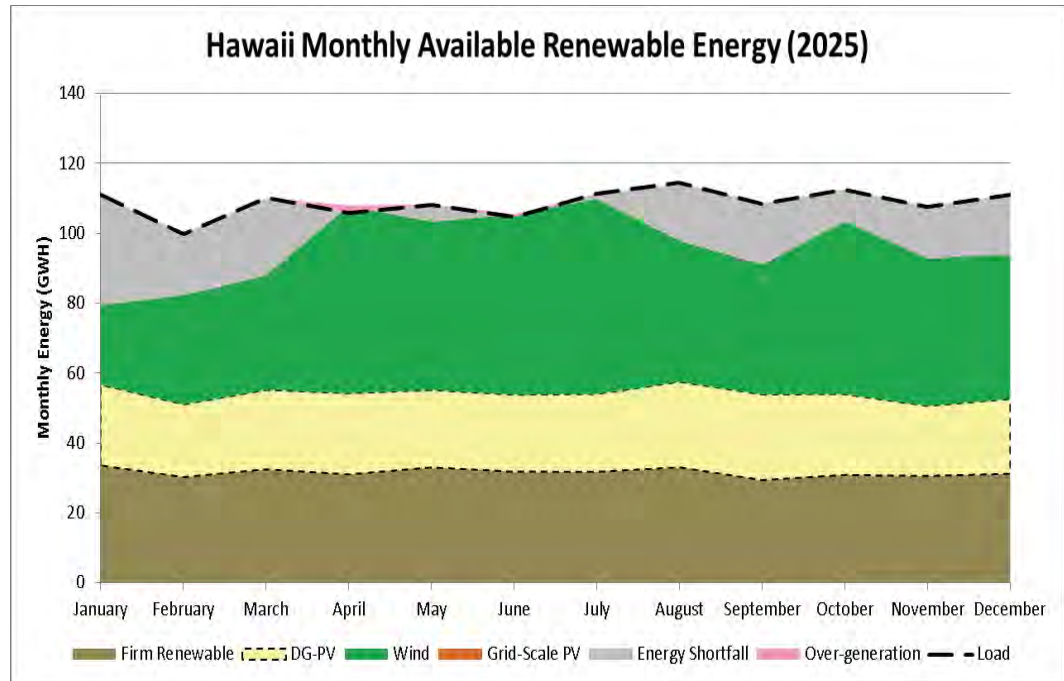

Figure K-100. E3 Plan Monthly Available Renewable Energy vs Load on Hawai'i Island in 2025

Figure K-101 shows the difference between the load and the available renewable energy in the year 2045 for the E3 Plan. Despite having high amounts of renewable energy available in some months, creating a surplus, shown in pink, there are some months for which there is a deficit, shown in gray. This highlights the continued need for thermal generators to provide supplemental generation during these shortfall periods or energy storage systems, which are capable of shifting energy over several months from the months where there is a surplus to the months where there are shortfalls.

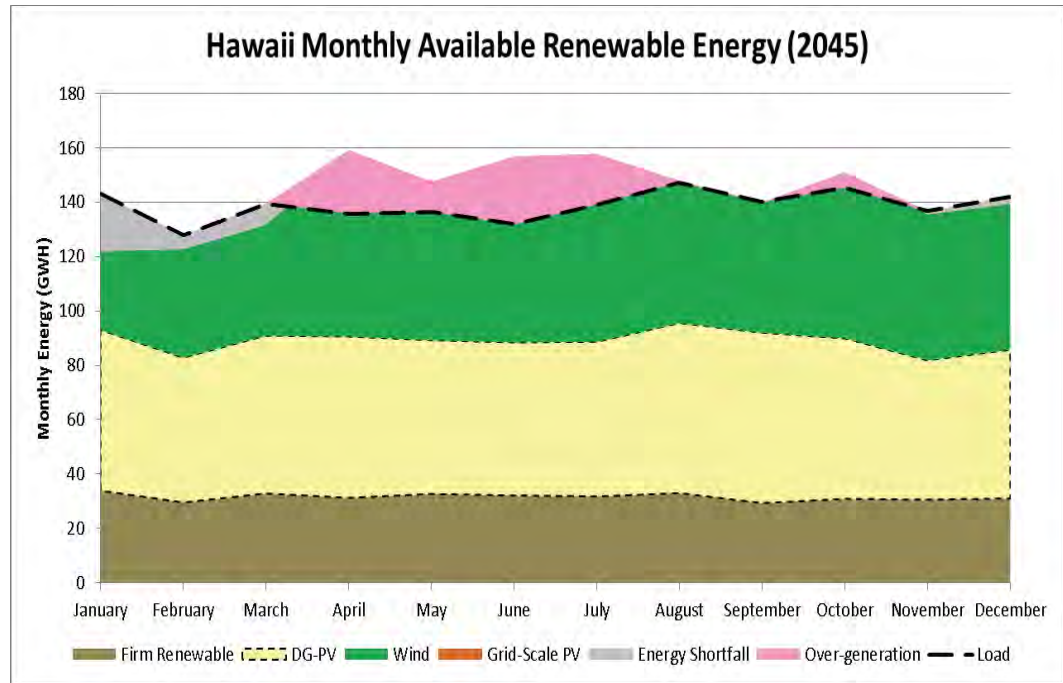

Figure K-101. E3 Plan Monthly Available Renewable Energy vs Load on Hawai'i Island in 2045

### Sub-Hourly Charts of Hawai'i Island Plans

Sub-hourly modeling was performed to analyze the impact that variable renewable energy would have on our system, and whether our portfolio of generators and storage systems would be sufficient to stabilize the electrical grid.

Historical minutely renewable energy data was used to determine the volatility of solar and wind resources on Hawai'i Island. The volatility of the Apollo wind farm was applied to future grid-scale Wind resources.

An initial screening was done to determine the month with the largest potential minutely downward ramp. PLEXOS was then employed to perform a stochastic analysis on this month. Using the historical minutely data, stochastic variables were created for all as-available resources and the load. Shown below are the results from the sub-hourly analysis of the E3 Plan when a 1-, 15-, and 30-minute look-ahead is assumed.

Figure K-102 shows the estimated unserved energy at a 1 minute look-ahead. To analyze the impact of the 12 MW 4-hour load-shifting battery installed in the E3 Plan in 2020, Figure K-103 shows the estimated unserved energy at a 1 minute look-ahead without the battery in-service.

## K. Analytical Steps and Results

### Hawai'i Island Analytical Steps and Results

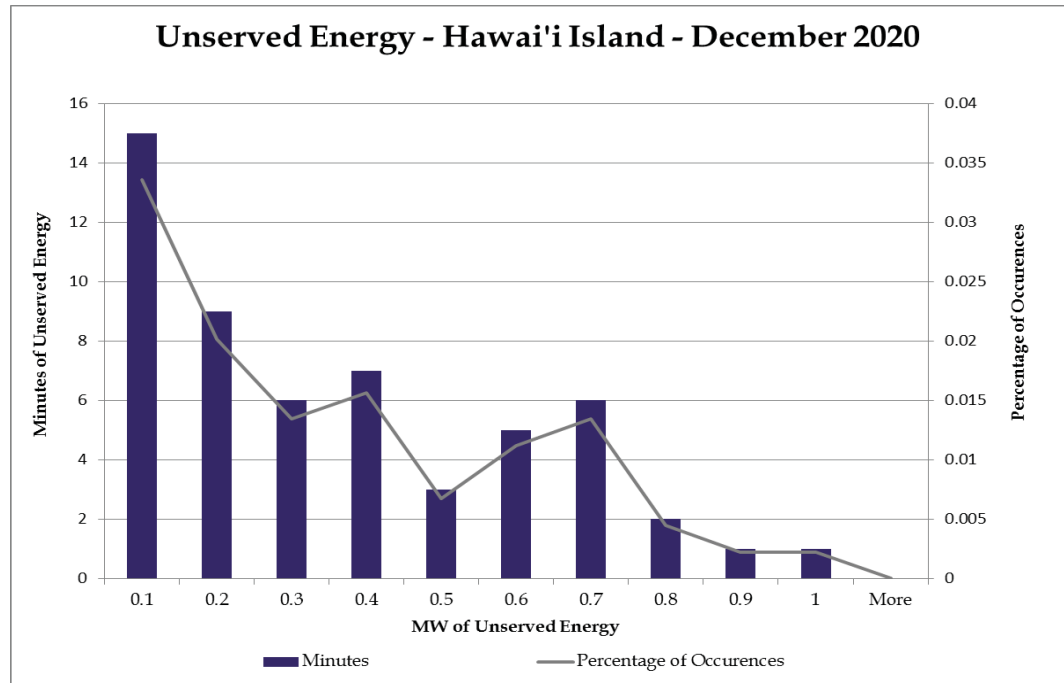

Figure K-102. Sub-Hourly Unserved Energy for E3 Plan on Hawai'i Island at 1-Minute Look-Ahead

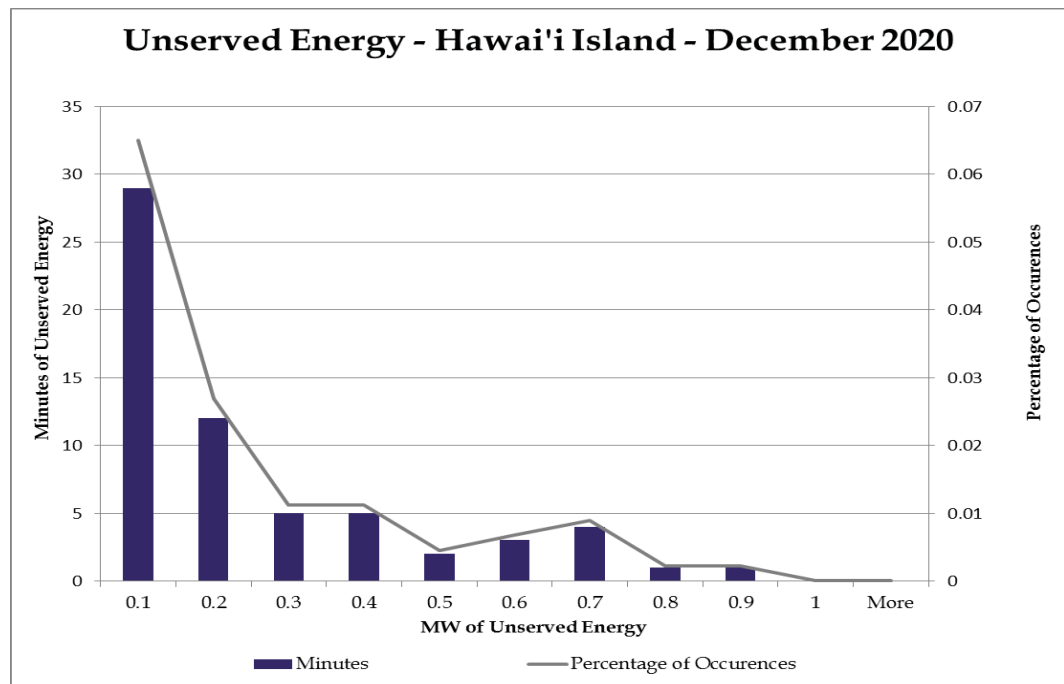

Figure K-103. Sub-Hourly Unserved Energy for E3 Plan on Hawai'i Island at 1-Minute Look-Ahead without Load-Shifting Battery

As shown in Figure K-104, the unserved energy magnitude and number of occurrences significantly decreases with 15 minute look-ahead.

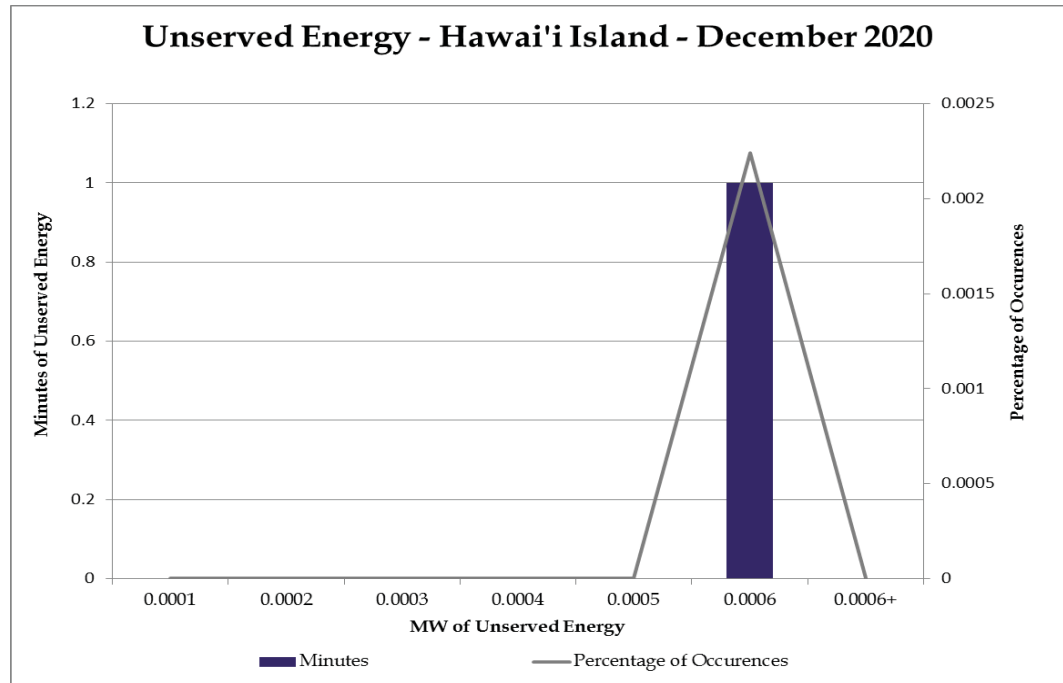

Figure K-104. Sub-Hourly Unserved Energy for E3 Plan on Hawai'i Island at 15-Minute Look-Ahead

With a 30 minute look-ahead setting, there is virtually no unserved energy.

### Daily Energy Charts of Hawai'i Island Plans

The charts in the previous sections displayed annual and monthly views of how renewable energy is being integrated into the plans and the impacts to the system energy production. This section will convey a more granular view by providing the energy mix for select days of some years of the plans that were modeled.

## K. Analytical Steps and Results

### Hawai'i Island Analytical Steps and Results

#### High Over-Generation Energy Profiles for E3 Plan

Figure K-105 provides a view of the day in the year 2020 that has the highest amount of over-generation for the E3 Plan. It can be seen that during the middle of the day, almost all of the load is being served by renewable energy. During this time, storage is being charged then discharged in the evening.

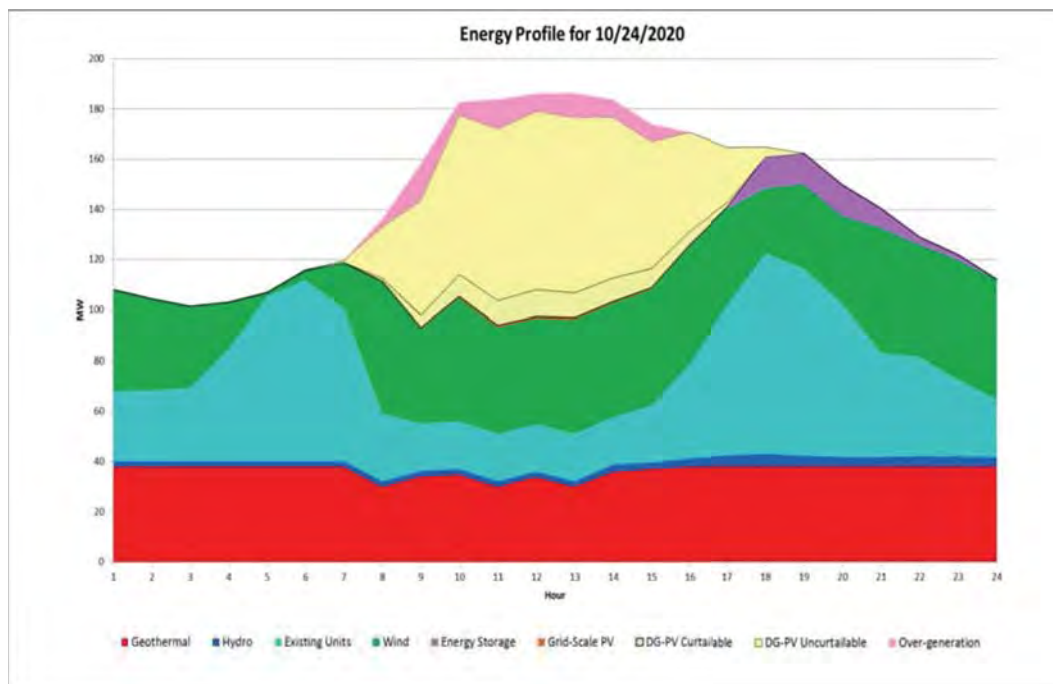

Figure K-105. E3 Plan Hawai'i Island High Over-Generation Energy Profile: 2020

Figure K-106, Figure K-107, and Figure K-108 shows virtually all of the energy provided on high over-generation days in 2030, 2040, and 2045, respectively, is through renewable resources. On these days, over-generation occurs in almost every hour of the day and energy storage is discharged in the evening.

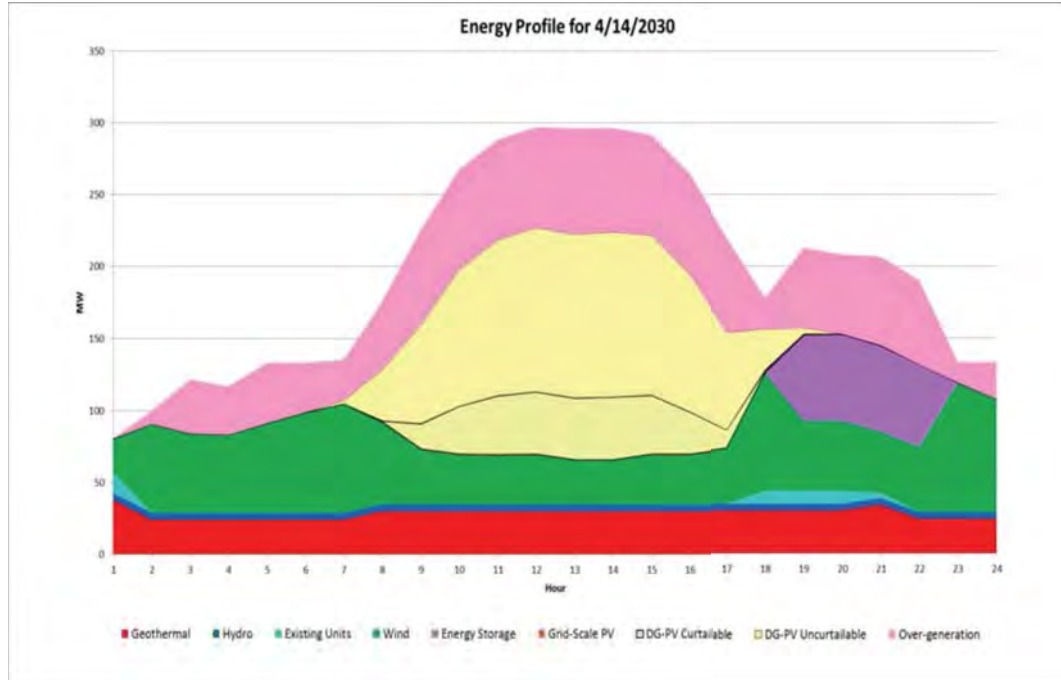

Figure K-106. E3 Plan Hawai'i Island High Over-Generation Energy Profile: 2030

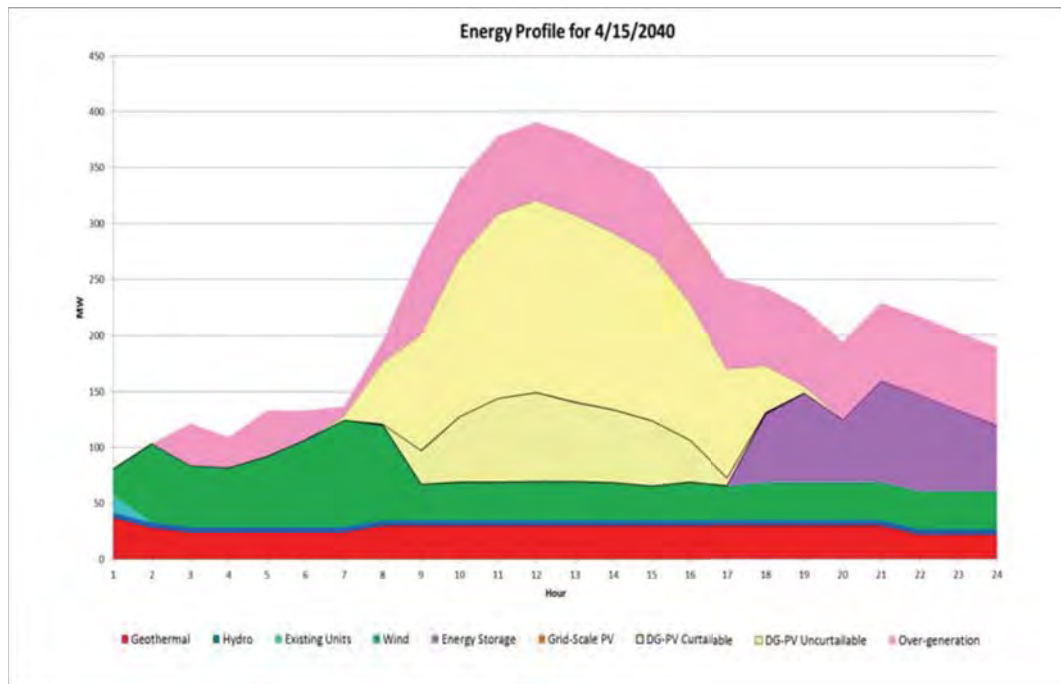

Figure K-107. E3 Plan Hawai'i Island High Over-Generation Energy Profile: 2040

## K. Analytical Steps and Results

### Hawai'i Island Analytical Steps and Results

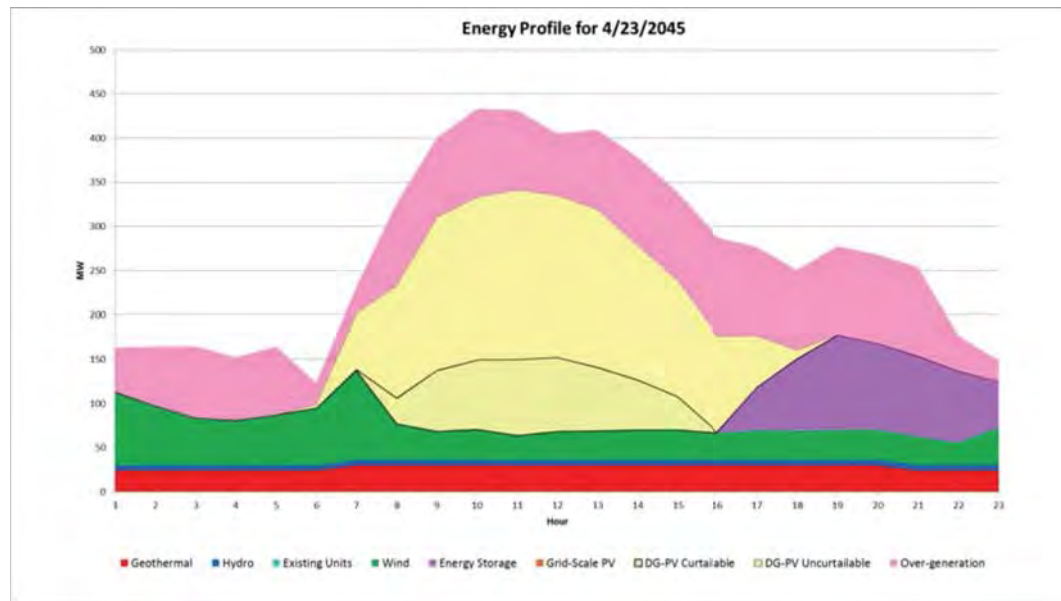

Figure K-108. E3 Plan Hawai'i Island High Over-Generation Energy Profile: 2045

### Low Renewable Energy Profiles for E3 Plan

Although Hawai'i has abundant renewable resources, such as wind and solar, there are days for which there is limited solar and/or limited or no wind available. Figure K-109, Figure K-110, Figure K-111, and Figure K-112 illustrates how different the energy profile is for the days with low renewable energy available in the years 2020, 2030, 2040, and 2045, respectively, for the E3 Plan. Even in later years, such as 2040 and 2045, where there are significant amounts of renewable resources and energy storage included in the plan, on these low renewable days, thermal generation is still necessary to serve the load.

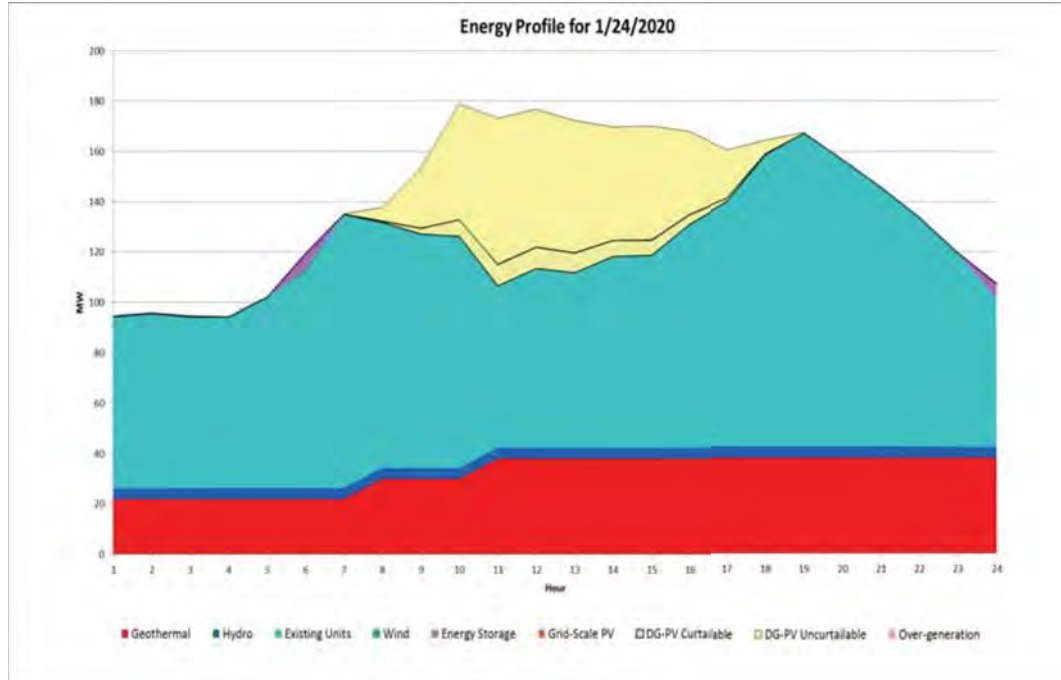

Figure K-109. E3 Plan Hawai'i Island Low Renewables Energy Profile: 2020

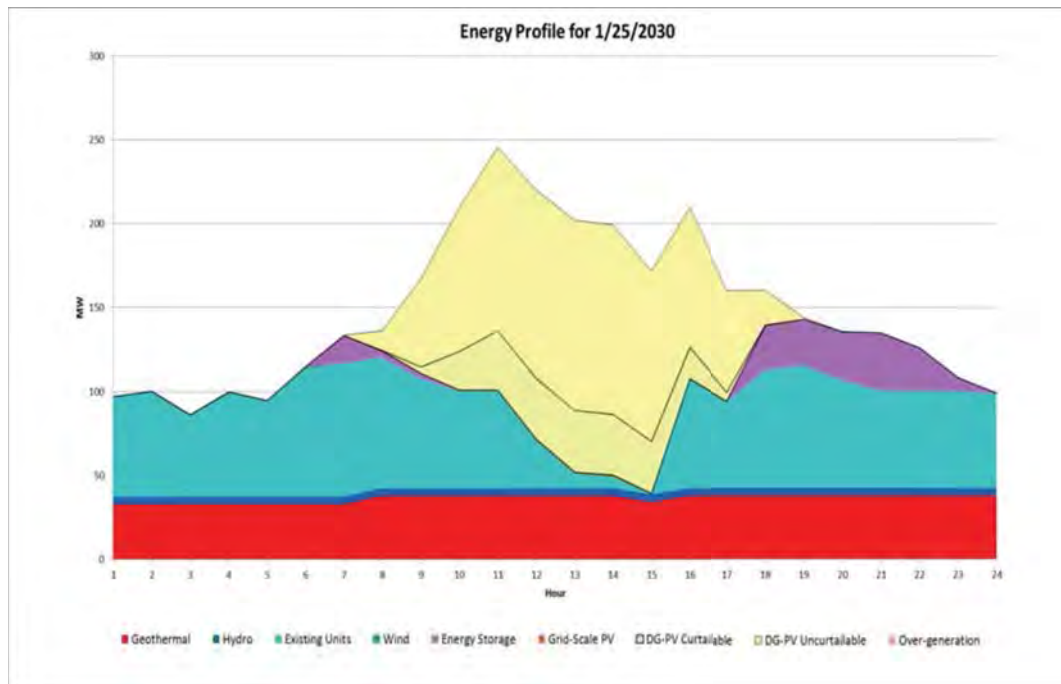

Figure K-110. E3 Plan Hawai'i Island Low Renewables Energy Profile: 2030



## K. Analytical Steps and Results

### Hawai'i Island Analytical Steps and Results

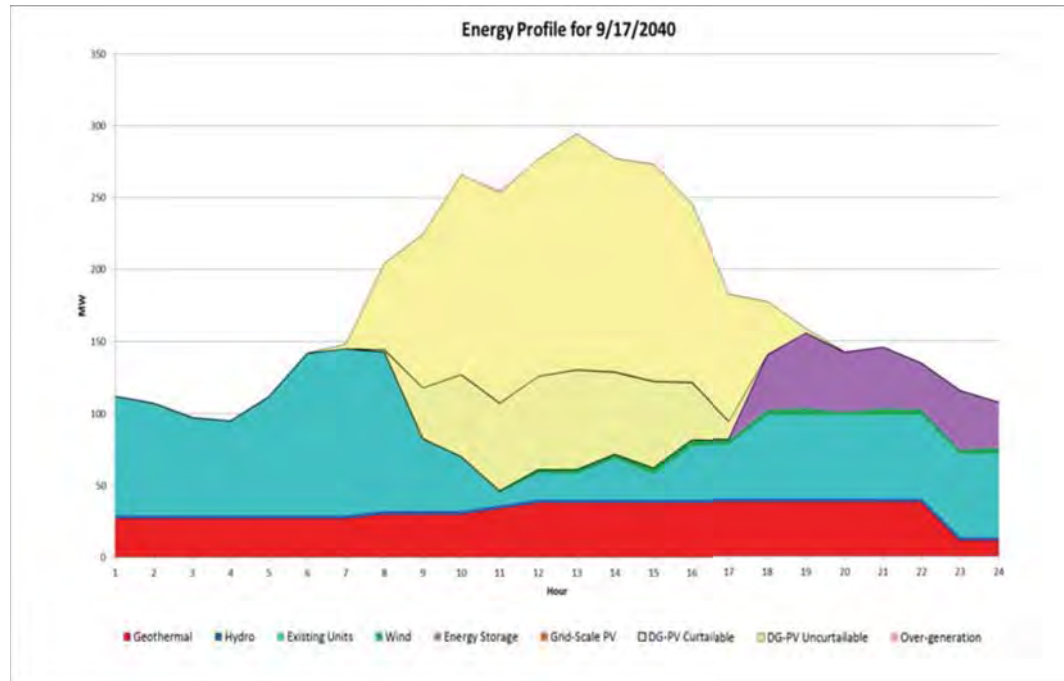

Figure K-111. E3 Plan Hawai'i Island Low Renewables Energy Profile: 2040

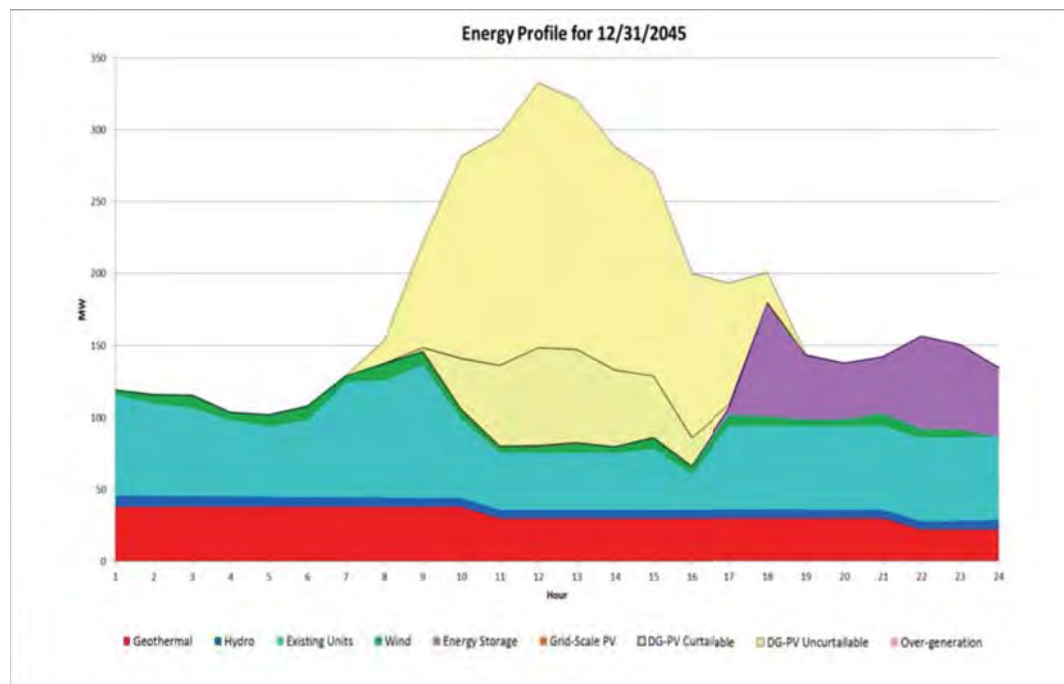

Figure K-112. E3 Plan Hawai'i Island Low Renewables Energy Profile: 2045

### High Over-Generation Energy Profiles for Post-April PSIP Plan

Since the Post-April PSIP Plan has a different resource mix than the E3 plans, the daily energy profiles for the same years (2020, 2030, 2040, and 2045) are provided below.

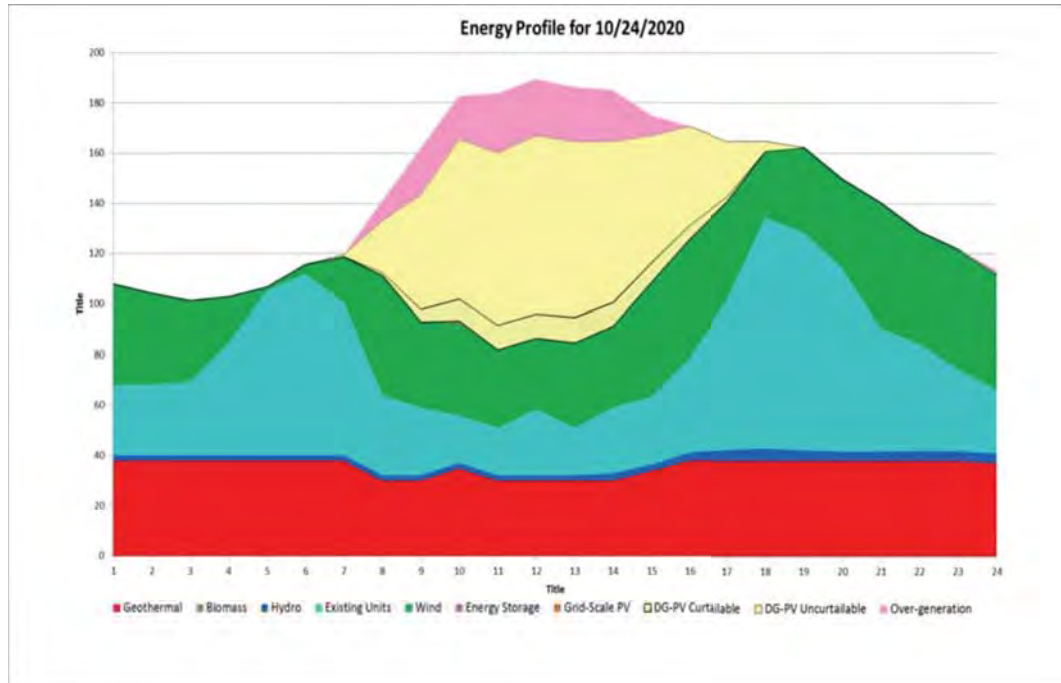

Figure K-1 I 13. Post-April PSIP Plan Hawai'i Island High Over-Generation Energy Profile: 2020

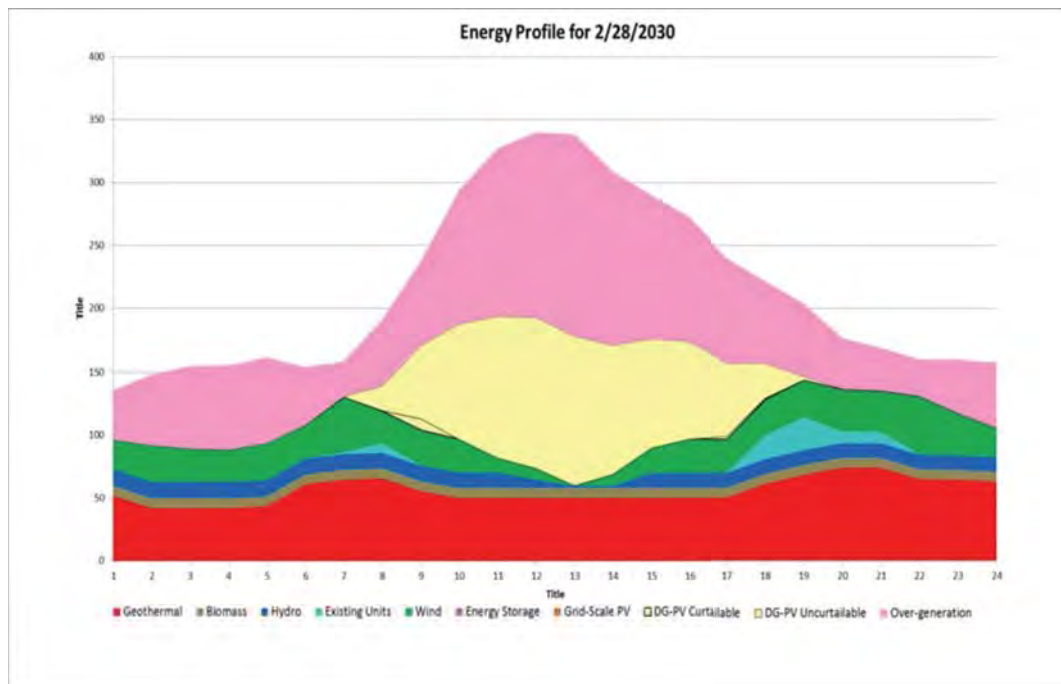

Figure 4-1 I 14. Post-April PSIP Plan Hawai'i Island High Over-Generation Energy Profile: 2030

## K. Analytical Steps and Results

### Hawai'i Island Analytical Steps and Results

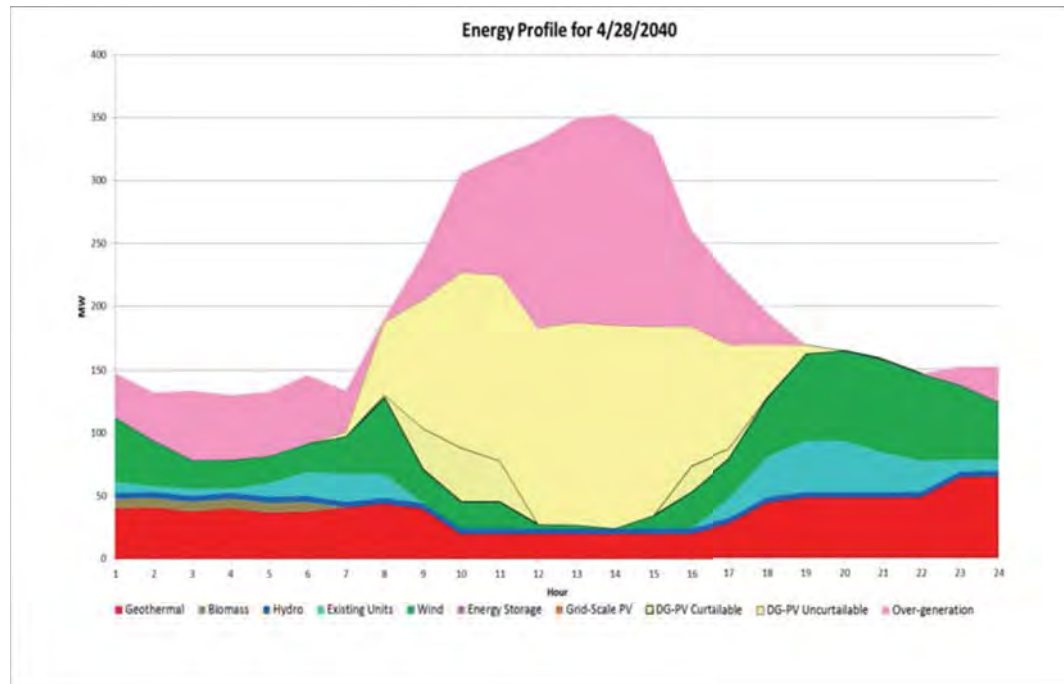

Figure K-I 15. Post-April PSIP Plan Hawai'i Island High Over-Generation Energy Profile: 2040

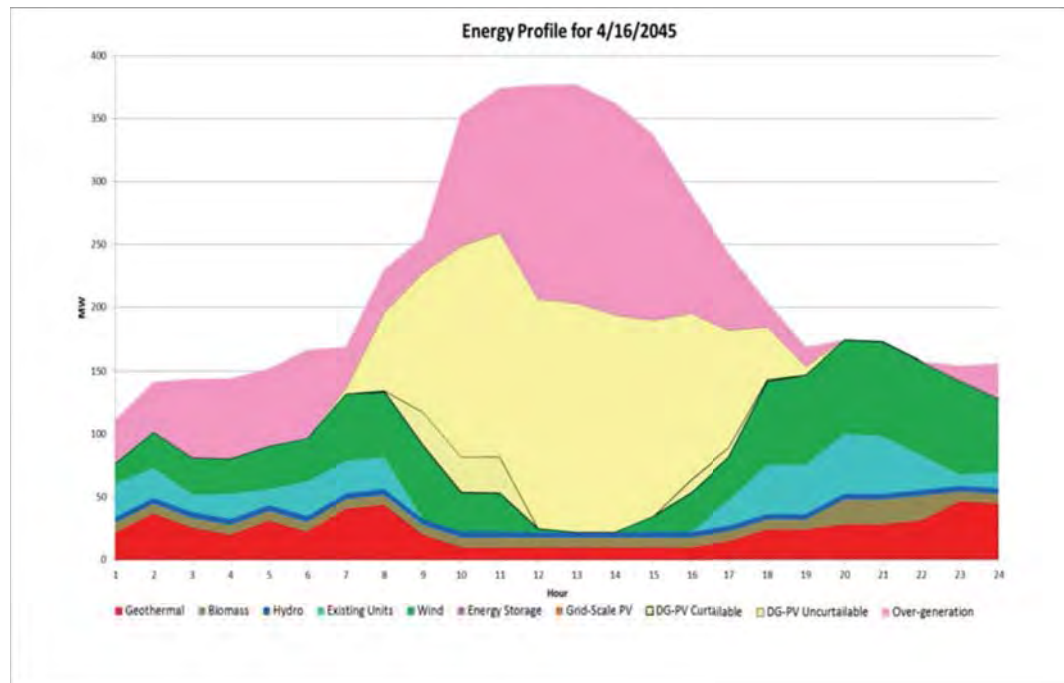

Figure K-I 16. Post-April PSIP Plan Hawai'i Island High Over-Generation Energy Profile: 2045

### Low Renewable Energy Profiles for Post-April PSIP Plan

The daily energy profiles for the same years (2020, 2030, 2040, and 2045) for the Post-April PSIP Plan are provided below as a comparison to the E3 plans.

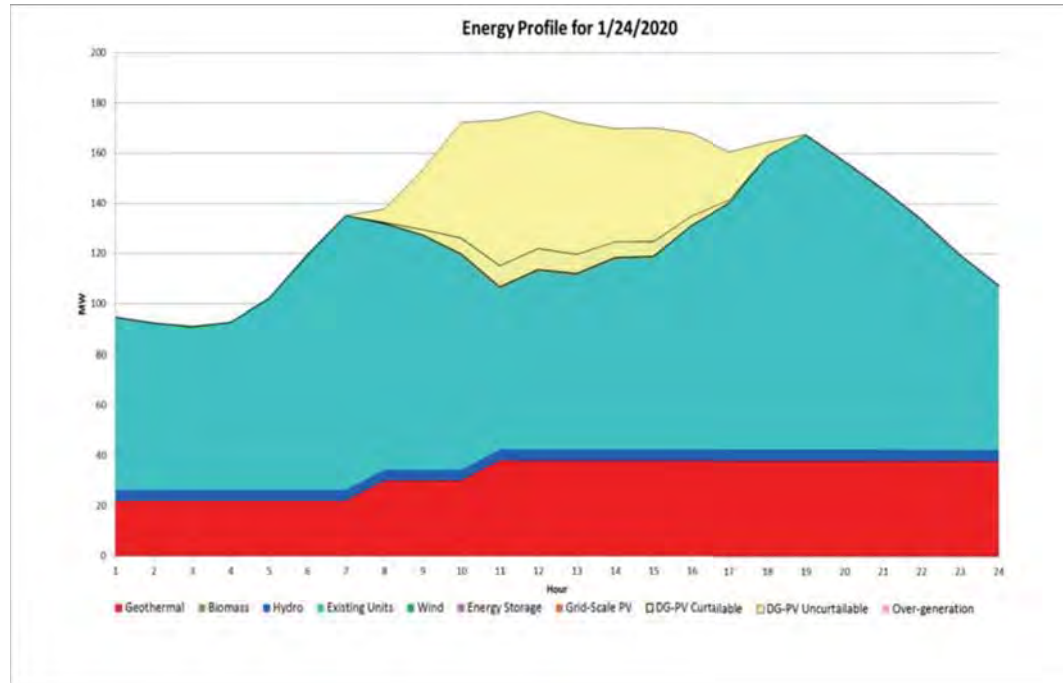

Figure K-I 17. Post-April PSIP Plan Hawai'i Island Low Renewables Energy Profile: 2020

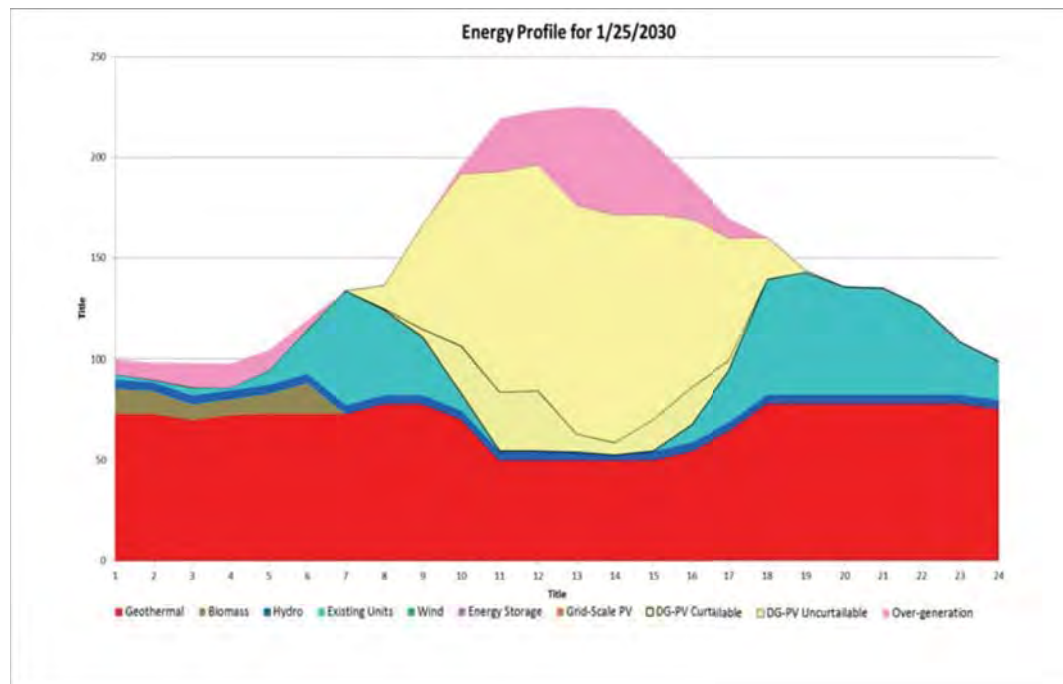

Figure K-I 18. Post-April PSIP Plan Hawai'i Island Low Renewables Energy Profile: 2030

## K. Analytical Steps and Results

### Hawai'i Island Analytical Steps and Results

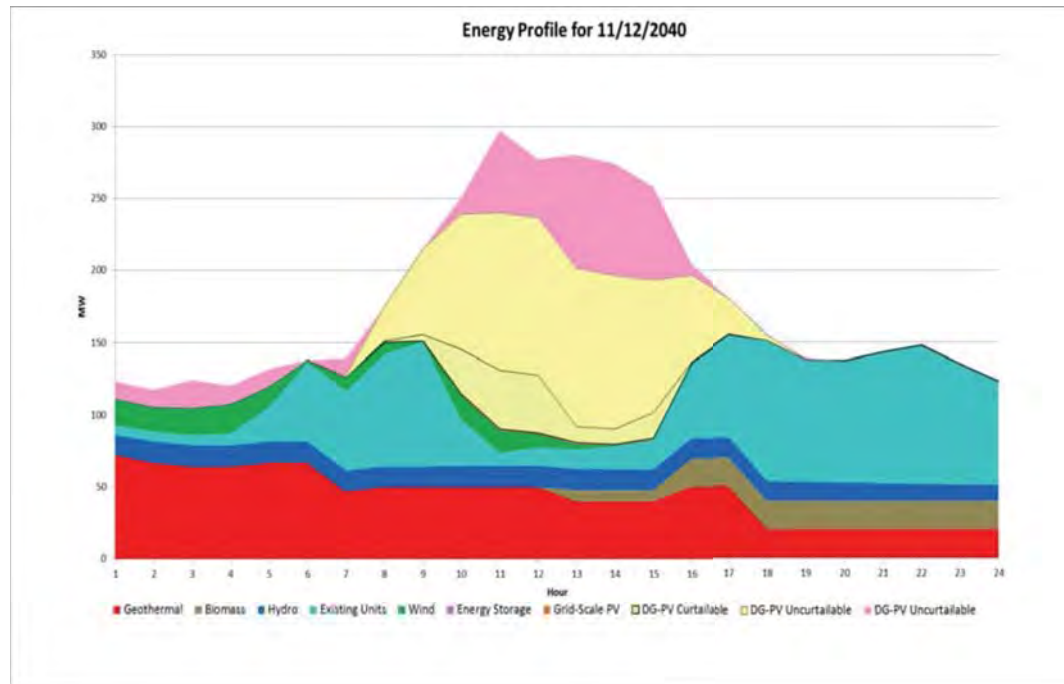

Figure K-119. Post-April PSIP Plan Hawai'i Island Low Renewables Energy Profile: 2040

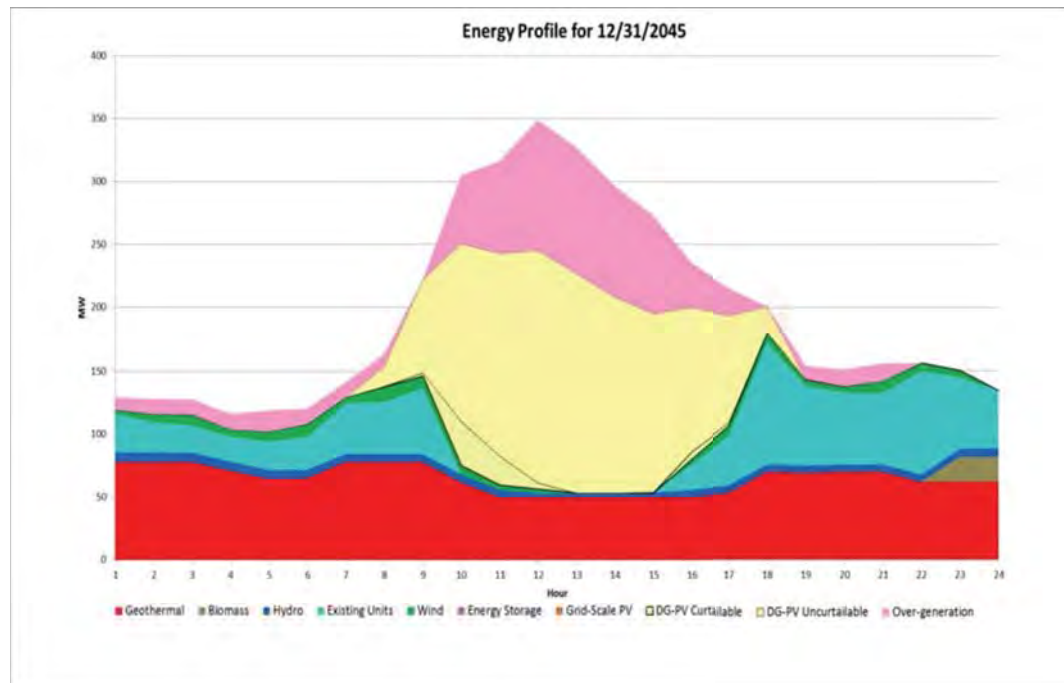

Figure K-120. Post-April PSIP Plan Hawai'i Island Low Renewables Energy Profile: 2045

## L. EPRI Reserve Determination

Hawaiian Electric has assembled a study team to propose a new method for determining operating reserve requirements based on an EPRI study for determining the impacts of wind and solar on system operations. Since the O‘ahu island system is highly sensitive to frequency swings, this study, conducted only on the O‘ahu grid, focused on short-term frequency regulating reserve.

The study uses a multi-cycle power system operations model (one that simulates the multiple decision-making procedures taken in real operations) to:

- Analyze costs, area control error (ACE), and frequency of the current reserve requirement method versus the proposed method – for current and future renewable penetration on the O‘ahu system.
- Represent the various decisions made by O‘ahu system operators.
- Stochastically represent wind, solar, load, and outages, as well as short-term operations.

The study also considers sensitivities, including using battery energy storage systems (BESS) and regulation reserve during renewable ramping periods combined with a generating contingency event.

This process will allow us to better understand how reserves are currently being used and how new methods (including those based on the stochastic nature of wind, solar, and load) could improve upon the optimal amount of reserve needed for the system. The study’s finding will inform the development of new short-term operational tools to manage wind and solar variability and uncertainty, which might include conditional rules for procuring and deploying reserves. The study also examines how a BESS installed and used for providing reserves operates.

The study progressively adds more detail to individually examine each of these factors.

## L. EPRI Reserve Determination

### Assessment of GE study And EPS Reserve Methodology

When the study completes, EPRI and Hawaiian Electric will work together to ensure that the results can be transferred to operating practices and their energy management system tools. The goal is not to develop online operating tools, but rather examine some of the potential operating solutions through realistic simulations.

The study team is using the FESTIV simulation tool which incorporates unit commitment, economic dispatch, automatic generation control, and contingency-based operator action. The tool is unique in being able to simulate the long-term scheduling and commitment of resources days and hours ahead, while also simulating the fast second-to-second control and frequency impacts of the system.

Thus far, the study team:

- Collected eight weeks of historic high-resolution load, conventional generation, and renewable data, then constructed the input files necessary to run the simulation tool.
- Developed a module to better simulate frequency of the O'ahu system using the O'ahu frequency bias and ACE.
- Developed a module to mimic O'ahu's "equal lambda criterion" automatic generation control (AGC) simulation model, which determines production levels based on O'ahu generator quadratic cost functions.
- Incorporated numerous reliability must-run, derate, and other specific rules to benchmark unit generation, frequency, and ACE.
- Performed simulations of all eight weeks using the base case reserve requirement method.
- Created near-future (circa 2018) cases from the eight weeks of high-resolution data to include the forecasted future central and distributed renewable resources.
- Performed simulations of the future cases and analyzed the frequency, cost, and ACE impacts under both the current reserve method and the GE-proposed reserve method.
- Repeated the simulations and the analyses of the future cases with all units (but Kahe 5 and Kahe 6) as flexible (rather than must-run) to understand how this will change the benefits and impacts of the reserve methodologies.

The study team will evaluate the periods where greater imbalance was occurring, and using probabilistic renewable generation forecasts and variability statistics, propose a reserve requirement determination method with improved performance based on economic or reliability factors. A preliminary evaluation of the benefits of implementing the EPRI methodology is expected sometime in the first quarter of 2017; the final analysis and report for the entire effort is expected by end of the second quarter of 2017.

O'ahu is using the GE method; Maui and Hawai'i Island are using the EPS method.

---

## ASSESSMENT OF GE STUDY AND EPS RESERVE METHODOLOGY

The report, *Proposed HECO Regulation–From Measured Wind and Estimated Solar Data* (conducted by EPS and published August 5, 2014), assesses their proposed reserve methodology. We forwarded this report to EPRI for their assessment. Based on a high-level review of the proposed approach, EPRI indicated that a more efficient reserve procurement approach can be specified while still maintaining a satisfactory level of reliability. EPRI suggested four categories of improvements. The first improvement's description is different for the GE study and EPS methods. The remaining three improvements are essentially the same for both methods.

### *GE Improvement 1: Assumption of Correlation of Wind and Solar with Load*

The GE study method improves upon the EPS reserve method in two ways:

- Assessing overall renewable ramps rather than just wind and solar ramps individually.
- Using the difference between daytime (with PV) and nighttime ramps (without PV), which can better show the maximum expected ramps for both periods.

Thus, the correlation between wind and solar is captured to better determine overall regulation needs for the system. From EPRI simulations, this results in a much lower reserve requirement for a lower system cost with negligible reliability impacts. For example, evaluating a week in Spring 2014 showed costs reduced by \$35,000 while the standard deviation of ACE was decreased by 0.2 MW. In addition, Hawaiian Electric's compliance measure (the percent of time where frequency deviates by more than 50 MHz) was decreased by 0.2%.

Hawaiian Electric plans to assess how the renewable impact correlates with load ramps, as the load level can have a significant impact on the anticipated level of ramping on the system.

### *EPS Improvement 1: Assumption of Correlation of Wind and Solar with Load*

The EPS method presented separate, total regulation requirement for wind and solar, based on covering large ramps of each type of resource. Separating the requirements for isolating wind and PV ramping to attain the total required regulation essentially assumes that wind and solar are perfectly correlated (that is, the largest wind ramp will occur simultaneously with the largest solar ramp).

The EPS proposed method calculates reserve requirements based on total wind or total solar rather than summing the requirement to cover the ramping of individual wind plants and individual solar plants. Because of this, the reserve determination requirement should consider the total ramp from total renewables based on output level rather than



## L. EPRI Reserve Determination

### Assessment of GE study And EPS Reserve Methodology

each technology individually. For example, it may be that the EPS method requires substantial regulation requirement to cover wind ramps that are ramping down during a period when solar is ramping up such that the net variability is not as significant.

Similarly, the reserve requirement should be evaluated with load to cover the net load variability and not just the aggregate renewable ramping. Requirements can use multi-dimensional lookup tables for regulation requirements (for example, for particular wind, solar, and load conditions, carry some MW level of regulation reserve).

With further analysis, this enhancement to the method can reduce the amount of reserve while having negligible reliability impacts. This would involve assessing the relationship between wind, solar, and load variability and, based on this relationship, developing a requirement to cover the maximum largest ramps.

One of the key challenges will be ensuring sufficient representative data is available so that the worst case events can be identified. Lacking sufficient confidence in this, then some margin may be needed above the amount that data analysis may identify as needed.

#### *GE and EPS Improvement 2: 1:1 Ratio and Percentage Level Cap*

The GE study and EPS methods use a 1:1 approach that requires 1 MW of reserve for every MW of production, up to a certain percentage level of wind or solar. Above that, no incremental reserve requirements are needed. The study team was unable to determine why these approaches were taken based on the data available to EPRI; the use of 1:1 ratios and the cap percentage above which no more is needed both seem arbitrary.

Figure L-1 and Figure L-2 shows that application of the GE study and EPS method requirement (respectively) in red for PV ramping data. This data is the Maui Electric results in holding more than twice the reserve required to cover ramps for some lower PV levels and a deficit in reserve to fully cover PV ramps for some higher PV levels.

Even if the system required 100% compliance of meeting the 20-minute ramp, a segmented curve that doesn't keep the arbitrary 1:1 ratio can be used as shown in yellow. This would meet all of the historical ramps based on the data shown, such that over-procuring reserve requirements would be significantly reduced. Even if a margin is desired, the yellow line is significantly lower at lower PV output.

Applying a segmented reserve requirement curve approach for each operating company may reduce costs by reducing unnecessary reserves while providing greater compliance by covering ramp events between 20 and 30 MW outputs – this wouldn't have been guaranteed in the previous method.

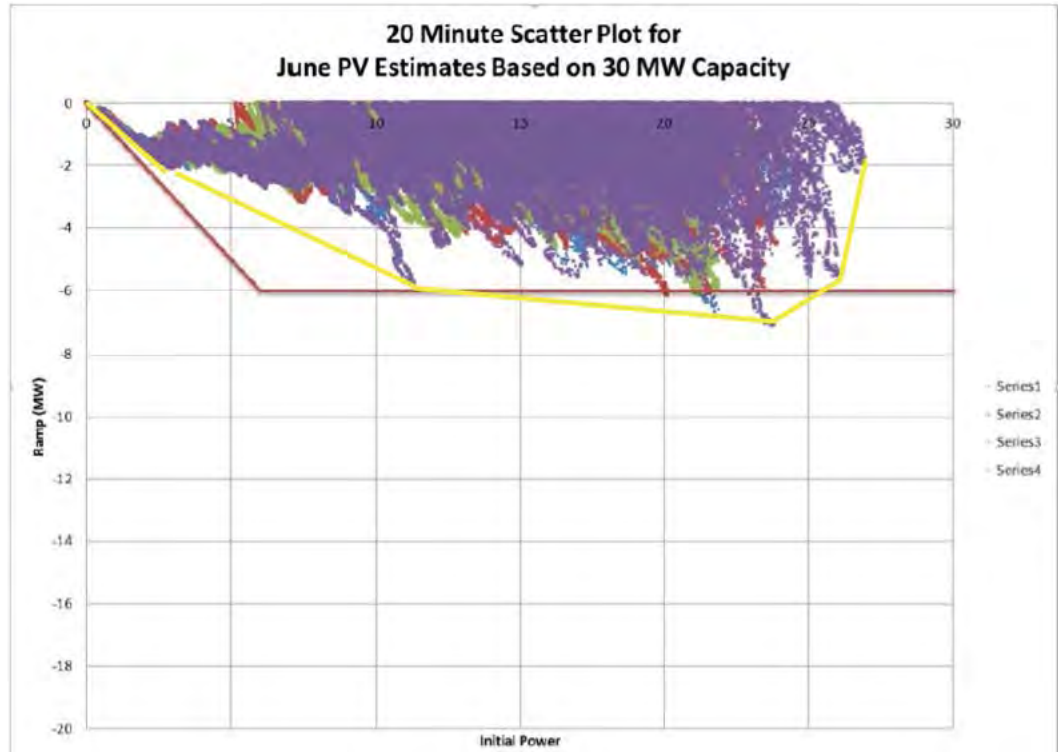

Figure L-1. GE Study Method 20-Minute Solar PV Ramp Rates: 100% Reserve Requirement

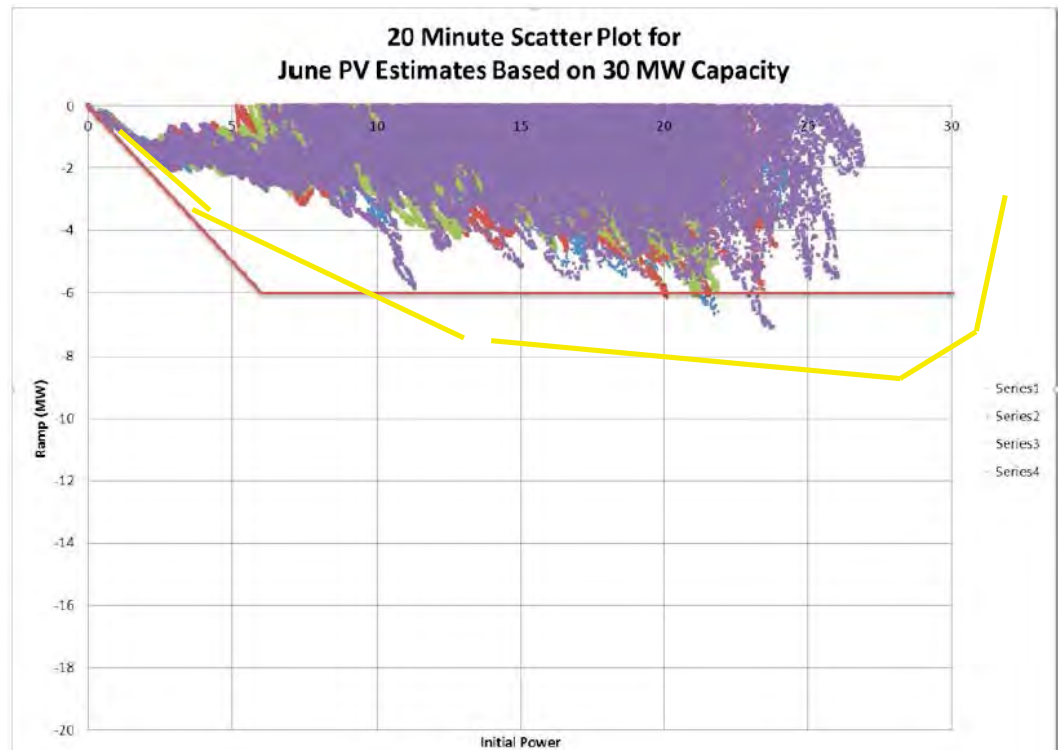

Figure L-2. EPS Method 20-Minute Solar PV Ramp Rates: 100% Reserve Requirement

## L. EPRI Reserve Determination

### Assessment of GE study And EPS Reserve Methodology

#### *GE and EPS Improvement 3: 100% Compliance Assumption*

Mainland balancing compliance requirements are based on statistically ensuring that imbalances do not get large enough to trigger under-frequency load shedding for N-1. They are also rarely defined other credible events (for example, N-2). For normal balancing, the current NERC standard is that the imbalance be less than some specified MW level for 90% of the time.

For an interconnected system with peak load similar to Hawaiian Electric, the imbalance level must be less than approximately 25 MW for 90% of the time. Because of the isolated nature of the O‘ahu island system, the allowable imbalance levels must be maintained lower than on mainland systems. This is because there are no neighboring areas to net out impacts and because frequency excursions are much larger for similar sized imbalances. Adjusting the Hawaiian Electric reserve requirement to allow for potential deficiency of a few MW 1% or less of the time is not likely to adversely impact reliability.

As a hypothetical example, the segmented reserve requirement represented by the orange trace (in Figure L-3 for the GE study, and in Figure L-4 for the EPS method for the same Maui Electric PV ramping, and based on graphical observation without reviewing data) would likely provide 99.9% compliance for meeting its ramping requirements. Any imbalances would cause a deviation of less than one MW with little impact to frequency error.

Hawaiian Electric can further improve its reserve requirement approach by reviewing its operating criteria for the level of imbalance that can cause a significant frequency deviation, any added safety margins (to account for starting frequency), and its agreed upon risk tolerance (or compliance standard) on how often to allow deviations of different magnitude.

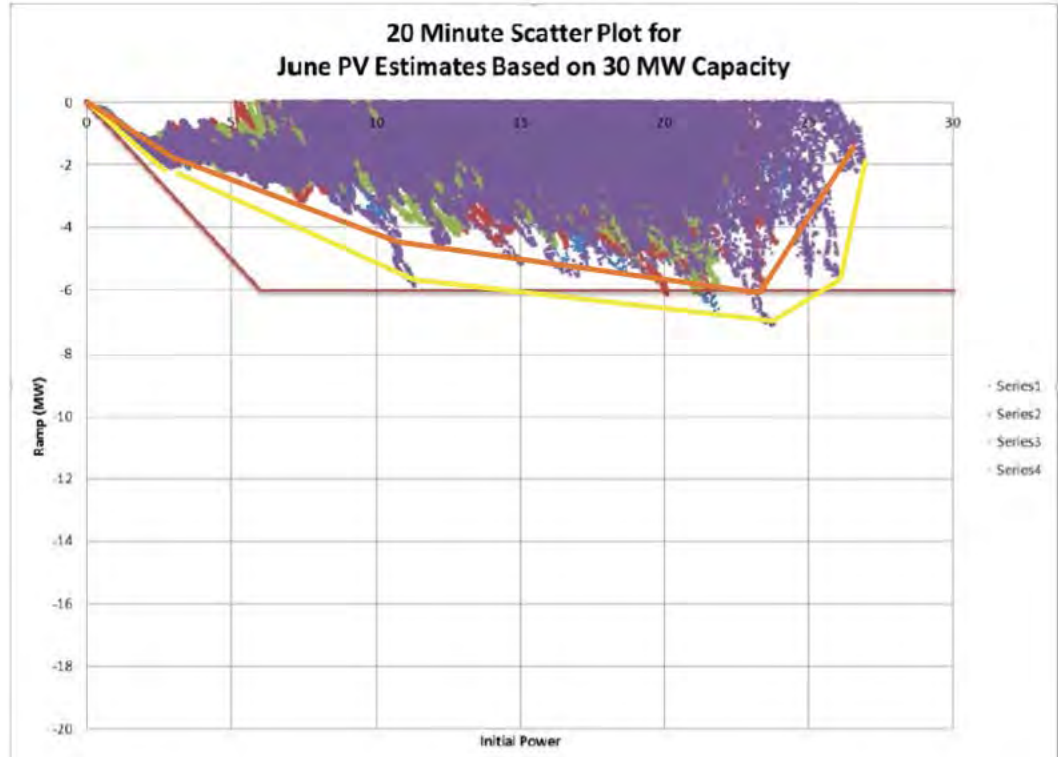

Figure L-3. GE Study Method 20-Minute Solar PV Ramp Rates: Segmented Reserve Requirement

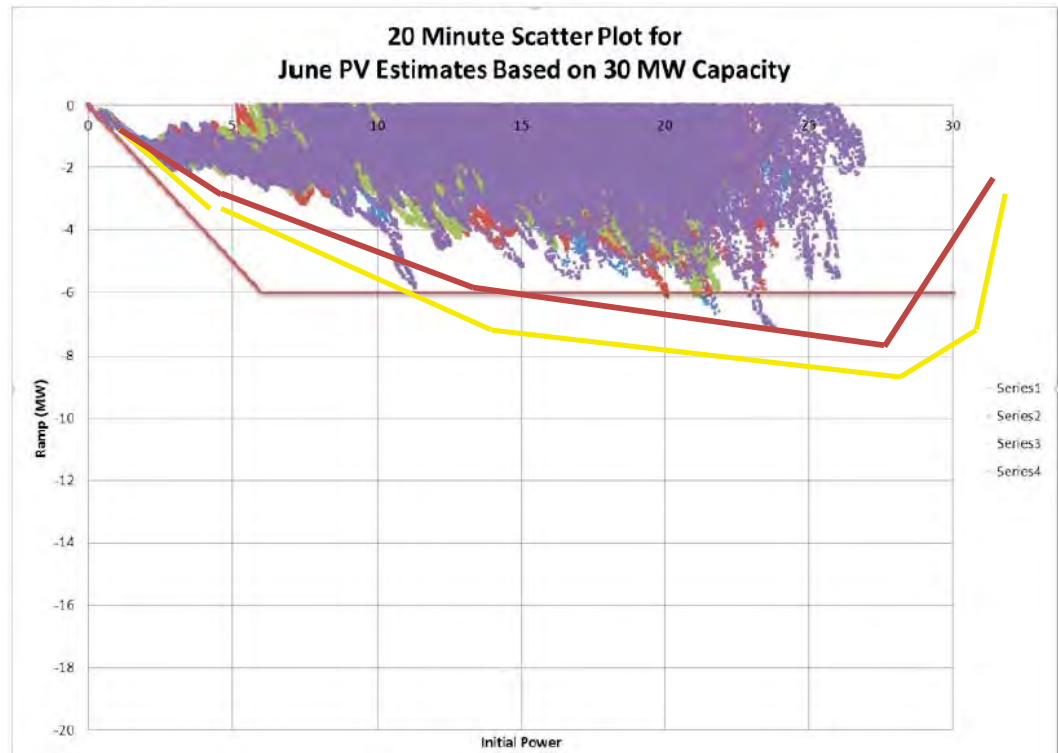

Figure L-4. EPS Method 20-Minute Solar PV Ramp Rates: Segmented Reserve Requirement

## L. EPRI Reserve Determination

### Reserve Determination Methods that Consider Renewable Output

#### *GE and EPS Improvement 4: Impact on the Predictability of Ramp Conditions*

The GE study and EPS reserve methods determine regulation requirements based on the ramp levels of wind and solar at various output levels. They do not, however, consider the predictability of those ramps. The predictability (or unpredictability) of the ramp can have a large impact on the reserve requirement.

For example, solar ramp down during the evening is easier to meet compared to an unpredicted random cloud cover. Being able to predict the ramp allows operators to schedule to commit additional resources beforehand so that they are prepared to turn on when the ramp occurs. They might not, however, be needed during other periods.

Whether this impact can increase or decrease requirements is unclear. Clarity would depend on the accuracy of the renewable resource forecasts, and its scheduling efficiency (scheduling and commitment of resources outside of regulating resources).

---

## RESERVE DETERMINATION METHODS THAT CONSIDER RENEWABLE OUTPUT

A number of other areas with high renewable penetrations are beginning to adjust their operating reserve requirements (mostly regulation reserve) to incorporate the impacts of renewables.

Although much larger than Hawaiian Electric, ERCOT is an isolated balancing area, although it has relatively small DC connection with other areas. ERCOT was one of the first regions that adjusted its reserve requirements based on renewable impact and kept a level of reserve that is not constant.

The following occurs in ERCOT's regulation reserve requirement methodology. ERCOT:

- Bases its regulation needs on meeting 95th percentile of all ramps by using data from the previous month and the same month in the previous year (for example, when calculating requirements for March 2016, they use mid-January to mid-February 2016 data and March 2015 data).
- Calculates requirements for each hour of the day in the following month, giving a 24-hour time series of requirements.
- Bases its regulation needs on meeting the NERC Control Performance Standard 1 that dictates how well it should balance generation and load
- Increases regulation due to wind generation by about 0.5% of installed capacity. For 1,000 MW capacity increase in wind, the regulation requirement is increased by 4–6 MW, based on the overall impacts on imbalance to the net load

- Bases the original level on previous deployments of the regulation, with regulation being used to meet overall net load imbalance

Other areas have described small changes to their regulation reserve requirements based on increased renewable penetrations. This typically includes regulation requirements that might be based on a percentage of load plus some quantity using the expected renewable output. Most of these are not as transparent as to how they are calculated compared to ERCOT. For example, SPP describes their regulation requirement as “based upon a percentage of forecasted load, adjusted up or down to account for resource output variability, and may vary on an hourly basis.” The incremental requirements from wind generation are based on both the anticipated forecast and the anticipated hour to hour change.

Other areas on mainland U.S. are also introducing new reserve products, similar to regulation. These products, typically referred to as ramping capability or flexibility reserve, are reserve held to be used in a continuous basis (similar to regulation), but are deployed on a 5–10 minute time frame rather than a second-to-second time frame. The requirements are used primarily to accommodate for renewable forecast error and renewable output ramps. The requirements are typically based on historical renewable ramps over the time frame of interest (typically 5 minutes, 10 minutes, or 30 minutes), and expectation to meet some percentile of those ramp events (for example, 95%). These products are now present in areas including California ISO, MidContinent ISO, and Public Service of Colorado. Others may introduce similar reserve products in the near future.

### References

These web links summarize some of these emerging requirements.

- EPRI, Reserve Determination Methods for Variable Generation: Industry Practices and the current research, Product ID 3002004242, October 2014.
- Ela et al., Operating reserve and variable generation, NREL tech report, 2011.  
<http://www.nrel.gov/docs/fy11osti/51978.pdf>
- ERCOT, Methodologies for Determining Ancillary Service Requirements.  
[www.ercot.com/content/mktinfo/dam/kd/ERCOT%20Methodologies%20for%20Determining%20Ancillary%20Service%20Requirements.zip](http://www.ercot.com/content/mktinfo/dam/kd/ERCOT%20Methodologies%20for%20Determining%20Ancillary%20Service%20Requirements.zip) (opens up zip file directly which contains word document)
- MISO, ramp capability white paper, 2013. <https://www.misoenergy.org/Library/Repository/Communication%20Material/Key%20Presentations%20and%20Whitepapers/Ramp%20Capability%20for%20Load%20Following%20in%20MISO%20Markets%20White%20Paper.pdf>
- CAISO, flexible ramping product project page: <https://www.caiso.com/informed/Pages/StakeholderProcesses/FlexibleRampingProduct.aspx>

## USE OF RENEWABLES FOR ACTIVE POWER MANAGEMENT

In many parts of the country and elsewhere in the world, renewables (wind and solar power) are used for various active power ancillary services to assist in meeting energy requirements and reliability needs. The description (with references) of two such services follows.

### *Service 1: Congestion Management and Redispatch*

In many areas of the United States, wind power is used for redispatch to maintain the energy balance and ensure transmission constraints are within their normal and contingency limits. Most U.S. independent system operators use wind to assist in congestion management.

When a transmission constraint is limited and wind may be the most efficient or only option to bring the flow within limits, the system operator will send a direction to curtail the wind resource within the next five minutes. This can also be important when thermal generation plants are at their minimum stable generating limits where they cannot back down any further and cannot turn off because of their minimum off time and start-up times when required to be on in the near future.

Curtailing wind and/or solar could be an economic means to handle high penetrations, where it is less expensive to curtail than cycle units on and off. For example, Xcel Energy use this procedure in their Colorado service territory (which is a vertically integrated balancing authority) to allow them to turn off coal units. During nighttime periods, coal could be turned off and wind could provide AGC to manage variability. This may also reduce the amount of variability present in the system, either by reducing up-ramps of wind or solar (downwards reserve) or by pre-curtailing before periods of large ramp downs in wind or solar.

### *References*

More information can be found in the following resources:

- NYISO, Integration of wind into system dispatch, 2008:  
<http://www.ferc.gov/CalendarFiles/20090303120334-NYISO%20Wind%20White%20Paper%20October%202008.pdf>
- MISO dispatchable intermittent resource program:  
<https://www.misoenergy.org/Library/Repository/Meeting%20Material/Stakeholder/Workshops%20and%20Special%20Meetings/2011/DIR%20Workshops/20110413%20DIR%20Implementation%20Workshop%20Presentation.pdf>

*Service 2: Frequency Control*

Wind power can provide frequency control (similar to the control of the turbine governor droop); it can respond rapidly to help stabilize frequency. Wind can also provide fast response, particularly to over-frequency events, by reducing impact (see Figure L-5). For sufficient under-frequency response, the wind facility has to be pre-curtailed, which may have economic or contractual consequences. If curtailed, wind can provide a fast response; in ERCOT, wind is required to do so only when curtailed for other reasons.

Solar is able to perform similarly. An accurate forecast of renewable output can also impact the ability of renewable generation to provide frequency response (particularly under-frequency response). When the forecast is inaccurate, the amount of frequency response from the renewable generation might be less than anticipated.

The controls to perform in this manner are readily available from the major wind turbine manufacturers, although they do need to be retrofitted to plants where they are not already installed. That said, having these controls enabled could potentially allow for other resources to be decommitted at times of high wind or solar output, when those resources can be curtailed to provide frequency response.

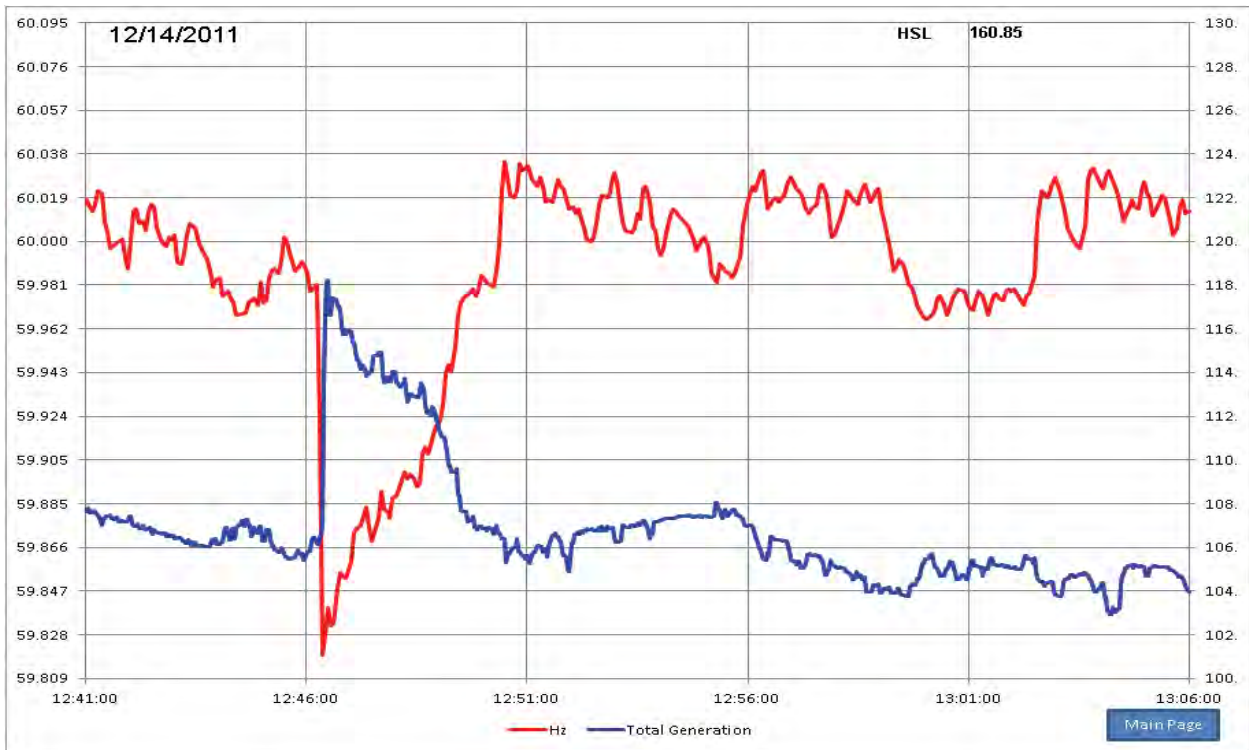

Figure L-5. Frequency Control Through Wind<sup>1</sup>

<sup>1</sup> Source: ERCOT website.



## L. EPRI Reserve Determination

Use of Renewables for Active Power Management

### References

More information can be found in the following resources:

- <http://www.nerc.com/pa/Stand/Reliability%20Standards/BAL-001-TRE-1.pdf>  
(Reliability criteria in ERCOT that describes wind's participation in providing primary frequency control)
- <http://www.nrel.gov/docs/fy15osti/64283.pdf>
- EPRI and NREL organized a project, as well as associated workshops, on the above topics of active power control for wind. More details can be found at <http://www.nrel.gov/docs/fy14osti/60574.pdf>

## M. Component Plans

To date, five Commission Orders have directed the Companies create a series of Component Plans. These Component Plans first appeared in Order No. 32053 for Hawaiian Electric, Order No. 31758 for Hawai'i Electric Light, and Order No. 32055 for Maui Electric. Order No. 33320 and Order No. 33870 reiterated this directive.

These Component Plans are:

- Fossil Generation Retirement Plan
- Generation Flexibility Plan
- Must-Run Generation Reduction Plan
- Environmental Compliance Plan
- Key Generator Utilization Plan
- Optimal Renewable Energy Portfolio Plan
- Generation Commitment and Economic Dispatch Review

Integrated throughout our planning and analysis, the Companies have worked toward satisfying the requirements stated in each of the Component Plans.

---

## FOSSIL GENERATION RETIREMENT PLAN

### Modernization Needs

Firm generating units that can be relied upon any time of day to provide power up to their nameplate capacity have historically been used to generate the bulk, if not all, of the energy needs for Hawai'i. As we move toward meeting the 100% RPS goal, many of these firm conventional generating units will be counted on less and less to provide energy because of increased levels of variable energy from photovoltaic (PV), wind, and other renewable power systems. This transition is already occurring, with variable generation providing a significant amount of the total energy needs for the Maui Electric and Hawai'i Electric Light systems. However, even after the state reaches its 100% renewable energy goal, firm generating units (operating on renewable fuels) remain essential components in the generating asset mix, albeit many of them having a different role than conventional generating units have today.

Although firm conventional units will gradually become less of the a primary energy source, they will provide supplemental resources: supplying customers' energy needs during periods with low variable energy production – periods with little sunshine, when the winds are calm, or during maintenance of large renewable assets. Firm generating units will also continue to enable reliable grid operation (for example, voltage stability and control, inertial response, and primary frequency response) and short-term balancing needs (such as replacement reserves). Of course, some types of firm renewable assets (such as biomass or geothermal) may continue to operate in a similar manner as historical conventional firm generation.

As the roles of firm generation assets evolve, the technical and operational capabilities of these units must match their new use pattern. To meet the future requirements, many existing generators must be modified or replaced to cost-effectively supply supplemental energy, fast balancing services, and other requirements identified for reliable and secure power delivery. Among other attributes, new assets need to have operational flexibility: the ability to start quickly, ramp up and down at high rates, and be designed to regularly start and stop multiple times daily even after long periods of being offline. Many existing firm generating units do not fully possess these characteristics. Often, newer generating units that bring more flexibility to the system will also provide improved fuel efficiency, resulting in lowering the amount of fossil fuel use while moving toward reaching the 100% renewable generation goal.

The timing of firm generation fleet modernization needs to consider several factors: the overall cost to customers for different resource options; objectives such as reducing fossil

fuel use (which is different than meeting RPS requirements); and system resource needs for reliable and cost-effective operation, including whether existing aging units can continue to provide reliable service after years of operation.

While it may appear that new efficient generating units will lower fuel costs for customers, this is often not the case. Although less fuel will be used because of increased efficiency, the type of fuel readily available and authorized to use in new modern units is likely to cost more. Historically, the fuel cost premium has outweighed the efficiency gains such that overall fuel costs would have increased with the installation of new modernized generation. When the capital cost of the new generation is also taken into account, costs to customers increase even more. However, this would not be the case if a low-cost fuel became readily available that could be permitted for use in modernized generating units (such as LNG). If that were the case, it is possible that fuel cost savings could override the capital investment of new generation, thereby lowering overall cost to customers.

Whether or not modernized generating units will result in fuel cost savings, it is evident their installations would reduce overall fossil fuel consumption in our journey to 100% renewable energy production. Depending on the types of new generation assets installed and the existing technologies being replaced, new modernized generating units could be 20% to 50% more efficient. While this reduction in fossil fuel use is not the same as adding renewable energy resources, it accomplishes many of the same goals envisioned by the RPS directives. Over time, these new modernized generating assets will transition to use only renewable fuels, thereby reducing fossil fuel use even further.

The time lines for reduced use of resources as primary energy providers, and the need for the full slate of enhanced operational attributes that come with new modernized generating units can be estimated from analyses in the PSIP process. However, what cannot be easily determined is how long existing aging generating units can continue to operate reliably, particularly considering the changing use pattern. Until new generating units are installed, existing generation must have increasing operational flexibility and be subject to layup, cycling, and ramping for which they were not originally designed. There is also potential for increasingly stringent environmental regulations to make them too costly for continued service.

What is clear, however, is that firm generating resources cannot be considered for removal while they are still required to provide reliable and secure service to customers. In addition, even if units are not needed for reliability, a choice may be made to keep them in service if they continue to be cost-effective to operate and maintain.

## M. Component Plans

### Fossil Generation Retirement Plan

We consider generating units for removal from service when all of the below are true:

- The cost of maintaining and operating the unit to provide bulk power needs is more expensive than an alternative means of serving bulk demand (for example, replacement generation is more economical, taking into account its capital cost, or the aggregate capacity value of variable renewable resources is sufficient to retire the unit).
- The unit is no longer required to meet adequacy of supply requirements (that is, providing capacity to meet reserve margins).
- The unit is not required for system security reasons (such as offline reserves, fast-start, system restoration, or other critical functions) or is not the most economical means of meeting system security (for example, when a different generator, BESS, or DR can provide a more economical source of these essential grid services).

Weighing factors of cost, need for greater flexibility, and maintaining reliability, the PSIP plans include dates to add new generation resources. In some cases, these additions will increase costs to customers but are prudent to continue providing reliable service for the changed operational and technical requirements of the generation fleet.

The plan to add new generation resources creates potential to remove from service existing generating units. This does not necessarily mean that we will remove generation units from service on the identified dates. We may adjust dates based on further optimization taking into account actual fuel costs and resource availability at the time of the decision, and on the timing of proposed renewable energy and firm dispatchable additions. A case-by-case evaluation will determine whether an existing unit will be immediately retired, deactivated, used for seasonal cycling, or kept operational. The goal is to manage these assets in a manner that provides maximum value for customers. If removal from service is enabled through addition of new resources, a period of time for the new resource to become reliable and proven will be accommodated before removal of existing assets, if practical.

## Hawaiian Electric's Plan for Retiring Fossil Generation

Hawaiian Electric owns and operates 12 steam generating units ranging in age from 35 years to 69 years. All of these steam units are currently needed to meet adequacy of supply criteria used for the O'ahu grid. Therefore, they need to remain operational until and unless new resources are installed that replace the capacity and ancillary services these steam units provide.

Technically, these steam units could operate indefinitely as long as maintenance and repairs are continued, which do have associated costs. To date, financial analyses taking into account these costs typically show it is still cost effective to keep the steam

generating units operating as long as they use a lower cost fuel than potential replacement generation.<sup>1</sup> However, it is not realistic or practical to plan for an indefinite lifespan of these older generating units for several reasons.

The capacity represented by the Hawaiian Electric steam units is necessary to reliably meet the energy needs of O‘ahu. As units age, unforeseen and unpredictable problems will arise more frequently, unless substantial capital renewal investments are made. This will be exacerbated by the expected operational profile (for example, offline cycling and potential intermittent periods of shutdown) will exacerbate this issue as the grid rapidly transitions to high penetration levels of variable renewable energy. The steam units are best suited for steady state, base load operations, not frequent ramping and cycling. These factors will lead to more frequent unplanned outages, which unlike planned outages can occur when the system does not have enough reserve capacity to reliably satisfy the island electricity demand. As the units age, there is increasing likelihood of unit outages resulting in generation shortfall.

The operations of the steam units will substantially change with the incorporation of increasing renewable energy, requiring flexible operation to supplement variable and renewable resources. Although measures have been taken to increase the flexibility of the steam units to allow higher penetration levels of variable renewable energy, these generating units cannot achieve the flexibility of other types of generation designed for offline cycling, fast start, and fast ramping. Meeting system needs may require adding new generating resources with these operational and technical capabilities, thereby rendering some of the existing units unnecessary. If this occurs, a case-by-case analysis would determine if certain existing steam units should be kept operational, used for cycling, deactivated, or decommissioned.

In addition to other factors, the steam units are subject to existing and future environmental regulations and requirements. Federal environmental regulations are intended, over time to prevent the degradation of air quality by requiring older, higher emitting electric generating units to retire or to install state of the art emissions controls. It is possible that environmental regulation considerations may require Hawaiian Electric generating unit changes (such as a switch to a higher cost fuel, or equipment retrofits, or costly environmental controls). If environmental considerations require a significant investment or change to higher-cost fuels, it is likely that replacement generation options would then be cost effective.

Recognizing these issues, we established dates by which we believe it will be prudent to install new generation resources, which also facilitates potential removal from service of

---

<sup>1</sup> The steam units use a #6 low sulfur fuel oil (LSFO), while new units are assumed to use readily available diesel fuel because environmental regulations would not allow them to use LSFO. Since the year 2000, diesel fuel prices were approximately 34.5% higher than LSFO on average.

## M. Component Plans

### Fossil Generation Retirement Plan

identified existing steam units. The governing philosophy in setting these dates was to minimize and spread out increasing costs to customers while at the same time ensuring installation of new generating units prior to experiencing major reliability issues with existing assets. Identifying dates also allows us planning for ramped-down maintenance on individual units, which typically starts six years prior to planned removal dates.

Based on assumed asset additions in the various resource plans, Table M-1 shows the corresponding dates for which O‘ahu’s steam units can be considered for service removal.

Date	Post April PSIP Plan	E3 Plan with Generation Modernization	E3 Plan with LNG and Generation Modernization
2022	AES*	AES*	AES*
2023	Waiau 3 & 4	Waiau 3 & 4	Waiau 3 & 4
2024	–	–	–
2025	Kahe 6	–	–
2026	–	Waiau 5 & 6	Waiau 5 & 6
2027	Kahe 1 & 2	–	–
2028	–	Kahe 5 & 6	Kahe 5 & 6
2029	–	–	–
2030	Waiau 5 & 6 Kahe 5	–	–
2031	–	Waiau 7 & 8	Waiau 7 & 8
2032	Waiau 7 & 8	–	–
2033	–	–	–
2034	Kahe 3 & 4	–	–
2035	–	Kahe 1 & 2	Kahe 1 & 2
2036	–	–	–
2037	–	–	–
2038	–	–	–
2039	–	Kahe 3 & 4	Kahe 3 & 4

\* Technically, AES isn’t being retired; we are allowing its Power Purchase Agreement (PPA) to expire without renewal.

Table M-1. Hawaiian Electric Generation Firm Generation Removal from Service Plans

To provide the most cost reduction to the customer, we plan to remove units in unit pairs because they share one control room, operator staff, and common equipment. The existing combustion turbine units, Waiau 9 and Waiau 10, are not in this removal plan because their design provides the type of flexibility needed in the future high as available renewable environment. However, these units are currently 43 years old and it may be prudent to replace them during the PSIP planning period. Ongoing reliability of these units and the cost to maintain that reliability will be measures of whether their replacement should be included in future plans.

## Hawai'i Electric Light's Plan for Retiring Fossil Generation

Historically, steam units provided the bulk of the island energy needs. As capacity needs increased, gas turbines and combined cycle resources were incorporated onto the system. These resources are more flexible and efficient than the steam units, but use a fuel which often costs higher than that used in the steam units. Hawai'i Electric Light owns and operates three steam generating units ranging in age from 46 years to 51 years. Currently, the steam units are in active operation as it is cost-effective for them to remain so. This is because the current cost of the fuel used in the steam units results in lower production cost than other energy resource options. When and if the fuel economics change to where it is no longer cost-effective to operate and maintain the steam units, and they are not needed for system reliability, the units will be removed from service. They would then follow a transitional plan prior to consideration for retirement, assuming the cost of maintaining and operating the unit to provide bulk power needs is not cost-effective at the time of the decision, the unit is not required for adequacy of supply, and the unit is not required for provision of reliable service. Adequacy of supply requires at least one of the steam units be kept available until additional capacity is added to the system.

While increasing flexibility is required from firm generation as variable resources increase on the system and larger conventional plants are displaced from operation, Hawai'i Electric Light has a significant amount of flexibility with its existing fast start diesels and simple-cycle combustion turbines. The diesels and simple-cycle initially provided fast-starting replacement reserves to restore under frequency load-shed customers and support short-term energy needs, and have proven useful in managing system balancing with a high penetration of variable renewable resources. Therefore, it is not a near-term priority to add new flexible generation to accommodate variable renewable generation.

However, these diesel engines and simple-cycle combustion turbines range in age from 19 years to 54 years. As such, it may be prudent to replace some of these assets during the 29-year PSIP planning period. Ongoing reliability of these units and the cost to maintain that reliability will be measures of whether their replacement should be included in future plans.

Table M-2 shows the units considered for removal from service and the corresponding dates. While the E3 plans identify CT2 in 2040, this is the black-start resource for system restoration located in West Hawai'i and its removal from the system would require addition of another West Hawai'i resource capable of being similarly used to restore the system from total outage. That would require a resource capable of remote startup by the System Operator without station power and operating in isochronous (local frequency control) mode. A black start resource must be capable of meeting load-changes occurring during cold load pickup and transformer inrush currents. An option could be to add a



## M. Component Plans

### Fossil Generation Retirement Plan

black-start diesel to Keahole sized to support startup of CT4 and/or CT5 without reconfiguration of auxiliary loads (the CT2 black-start diesel is not large enough).

Date	Post April PSIP Plan	E3 Plan	E3 Plan with LNG	E3 Plan with LNG; Keahole & HEP LNG Conversion
2020	–	Puna Steam Hill 5 & 6	Puna Steam Hill 5 & 6	Puna Steam Hill 5 & 6
2021	–	–	–	–
2022	–	–	–	–
2023	–	–	–	–
2024	–	–	–	–
2025	Puna Steam	–	–	–
2026	–	–	–	–
2027	Hill 5	–	–	–
2028	–	–	–	–
2029	–	–	–	–
2030	Hill 6	–	–	–
2031–2039	–	–	–	–
2040	–	CT2*	CT2*	CT2*

\* CT2 cannot be retired until replacement black-start resource is added to West Hawai'i.

Table M-2. Hawai'i Electric Light Firm Generation Removal from Service Plans

## Maui Electric Retirement Plan

The four steam units at the Kahului Power Plant (KPP) will be retired upon the installation of replacement generation capacity on Maui along with upgrades to the transmission system no later than November 30, 2024 (discharges to receiving waters cease after that under the KPP National Discharge Elimination System permit), whichever occurs first. Current plans are to have the new capacity and transmission upgrades in place by December 31, 2022.

While increasing flexibility is required from firm generation as variable resources increase on the system and larger conventional plants are displaced from operation, Maui Electric has a significant amount of flexibility with its existing fast start diesels and combined-cycle combustion turbines. Additionally, the intent is for new generating assets installed as replacement capacity for KPP and to satisfy near-term load growth to have high levels of flexibility. Therefore, it is not a near-term priority to add new flexible generation for the sole purpose of accommodating variable renewable generation.

However, these diesel engines and combined-cycle combustion turbines range in age from 18 years to 65 years. As such, it may be prudent to replace some of these assets during the PSIP planning period. Ongoing reliability of these units and the cost to

maintain that reliability will be measures of whether their replacement should be included in future plans.

Table M-3 shows Maui Electric’s schedule for removing existing fossil fuel generating resources from service.

Date	Post April PSIP Plan	E3 Plan	E3 Plan with LNG
2022	Kahului 1-4	Kahului 1-4	Kahului 1-4
2023	-	-	-
2024-2044	-	-	-
2045	-	Ma’alaea 4-13	Ma’alaea 4-11

Table M-3. Maui Electric Firm Generation Removal from Service Plans

### Background

KPP consists of four steam units totaling 35.92 MW (net) firm generating capacity with units K1-4 installed in 1948, 1949, 1954, and 1966 respectively. When operating, these units provide firm generation and contribute to system security by providing regulating reserve, system inertia, and voltage support.

In May 2013, the State of Hawai‘i Department of Health (DOH) advised Maui Electric of new requirements relating to cooling water discharge at KPP, impacting its National Pollution Discharge Elimination System (NPDES) permit. As a result, Maui Electric anticipated it would have to retire KPP by 2019, before having to meet the new cooling water discharge requirements, or implement a solution that would meet NPDES standards. This was reflected in the 2014 PSIP.

In late 2014, Maui Electric chose to pursue a 9.5-year compliance plan to be included in the NPDES permit. Including the compliance plan allows Maui Electric to continue operating KPP beyond 2019, and provides more time to secure replacement capacity and complete the necessary transmission upgrades in Central Maui. The NPDES permit containing the 9.5-year compliance plan was approved in June 2015, giving Maui Electric until November 2024 to cease water discharges at KPP, effectively requiring that KPP be retired at that time.

Potential alternatives (which would likely require modifying the existing NPDES permit) to terminating the discharge of water from KPP (such as a cooling tower, deep ocean discharge, and injection wells) all face a multitude of barriers (permitting, property acquisition, and easements) that would jeopardize their ability to be completed before the expiration of the NPDES permit. Indeed, given the discretionary permits as well as the cooperation and coordination from other landowners, it is questionable whether these solutions could be implemented at all.

## M. Component Plans

### Fossil Generation Retirement Plan

#### Other Considerations

In addition to addressing the concerns of the Commission regarding the curtailment of wind energy and meeting environmental requirements, other factors further solidified Maui Electric's decision to retire KPP. They include:

*Tsunami Mitigation:* Given its location along the Kahului shoreline, KPP is very susceptible to damage should Maui be impacted by a tsunami. As the need arises and is appropriate, Maui Electric will replace generating assets with generating facilities out of the tsunami inundation zone that will make the Maui grid more resilient against such a natural disaster.<sup>2</sup>

*Renewable Energy Integration:* The reduction to base load generation on Maui associated with retiring KPP and termination of the HC&S PPA will provide additional headroom for accepting variable renewable energy. Quick starting units will be sought as part of the solution to replace KPP's generating capacity, allowing greater operational flexibility.

#### Replacement Generation

Absent any replacement capacity, the retirement of KPP will result in a reserve capacity shortfall of at least 40 MW. Meanwhile, system peaks on Maui have been trending upward, driving the potential need for even more future capacity. To ensure adequate generating capacity for Maui's customers, Maui Electric, on May 5, 2016, requested the Commission open a docket to initiate procuring the necessary capacity.

A portion of the replacement capacity is planned to be located in South Maui to address that area's existing under-voltage risks. The generation would serve as a non-transmission alternative (NTA) to upgrading the transmission line serving South Maui. (The upgrade has received significant community opposition because of the aesthetic impact of upgrading the line.)

Our planning process considered a number of options for the replacement capacity for KPP. Ultimately, the resource will be selected based on the option that provides the best value to Maui Electric's customers.

Besides procuring replacement capacity, Maui Electric will continue to pursue non-generation alternatives to help meet the island's capacity needs, while minimizing future traditional generation. These alternatives include, but are not limited to, demand response, time-of-use rates, and energy storage. As a temporary near term measure, Maui Electric has begun the procurement of just under 5 MW of DG to be located at the Kuihelani substation in central Maui. An application for approval for the DG units was submitted in September 2016 to the Commission.

<sup>2</sup> Both KPP and Ma'alaea Power Plant are located in the tsunami inundation zone. As a result, the threat of damage from a tsunami plays a role in Maui Electric's decisions on where to locate future generation or other assets.

## Central Maui Transmission and Distribution Project

The Central Maui region plays a critical role on the island of Maui as it is the center of government and commerce. The Central Maui region is served by both the 69kV system and the 23 kV system with power provided by the Ma'alaea Power Plant (MPP) and KPP. The KPP retirement primarily impacts the 23kV system, which serves the areas of Kahului, Wailuku, and Wai'ehu. Over 13,000 Maui Electric customers are on the 23 kV system, including University of Hawai'i Maui College, Baldwin High School, Maui High School, Maui Mall, Community Clinic of Maui, Armory Reserve, Maui Arts & Cultural Center, Hale Makua, Maui Beach Hotel, Maui Sea Side Hotel, Wallace Theaters, Maui VET Center, War Memorial Stadium, Nan Inc., Sack N Save, Foodland, Young Brothers, State of Hawai'i Department of Transportation Harbors Division, County of Maui water facilities and waste water treatment pumps, Central Maui Landfill, and Ameron. It is imperative to continue to provide reliable, electrical services to this area.

After retiring KPP, the Central Maui load on the 23 kV system will be served primarily by MPP, and the Kaheawa and Auwahi windfarms via the capacity-constrained MPP-Waiinu and MPP-Kanaha 69 kV transmission lines. The 69kV transmission lines serving Central Maui need to be modernized and upgraded to ensure continued system reliability for the Central Maui region. In addition, the 23 kV system in Central Maui has three 69/23 kV transformers that connect the 23 kV system and the 69 kV system. These transformers are located at Waiinu, Kanaha, and Pu'unene substations. The loss of either the MPP-Waiinu 69 kV or the MPP-Kanaha 69 kV transmission lines (that is, defined as a N-1 contingency) during higher system load conditions results in under voltages and thermal overload conditions.

Under these contingencies, there is the potential for overloads to occur on the remaining transformers, depending on the load. If too much power is being transferred to the 23 kV system from the 69 kV system, the system may not be able to manage the transfer and could experience a voltage collapse and/or load shedding scenarios if further system disturbances or unanticipated load increases in the Central Maui region occur. To support the retirement of KPP and as part of grid modernization efforts, Maui Electric is proposing to upgrade the existing 23 kV Waiinu-Kanaha line to 69 kV (which includes 69 kV upgrades to the existing Waiinu and Kanaha substations). This is a major addition to the existing Kahului Substation, and a reconductoring (that is, increasing the transmission line capacity) of the existing MPP-Waiinu and MPP-Kanaha 69 kV transmission line.

These upgrades address the required N-1 Transmission Planning criteria, maintain required voltage limits, strengthen and complete the critical 69 kV link for Central Maui, and allow for continued and reliable service under contingency conditions (that is, during system maintenance and forced outages) and higher system loads.

## M. Component Plans

### Fossil Generation Retirement Plan

The Kahului Power Plant Retirement-Comprehensive Assessment (included in the 2014 Maui Electric PSIP) provides the technical analysis to locally reduce the amount of load and help with the voltage issues on the 23 kV system. In addition to upgrading the transmission system, we considered NTAs such as internal combustion distributed generation (DG), battery energy storage system (BESS), and synchronous condensers. The analysis, however, concluded that upgrading the transmission and distribution system is the most technically sound and viable option.

To more thoroughly investigate NTA options, a third-party NTA study was conducted in a joint effort by the engineering and planning firms of Tetra Tech and CH2M Hill. The NTAs assessed included:

- Firm dispatchable distributed generation (FDDG): similar to conventional generation, available to the utility for immediate dispatch
- Dispatchable standby generation (DSG): emergency generators
- Photovoltaic and battery (PV/battery): combination
- Firm dispatchable generation/battery energy storage systems (FDG/BESS)
- Synchronous condensers
- Static capacitor banks
- Demand response (DR)

The Tetra Tech/CH2MHill report identified FDDG as the only feasible non-transmission alternative that would effectively address the contingency overload and under voltage conditions in Central Maui. The Tetra Tech/CH2MHill report concluded that the only NTA that addresses the loss of generation from KPP, supports voltage stability, and prevents thermal overloads is the addition of new FDDG on the 23 kV system strategically located to serve the Kahului, Waiinu, and Wailuku areas. A potential site was identified in the Central Maui area; however, the County of Maui indicated that it does not consider FDDG in the Central Maui region as a viable NTA citing noise, traffic, and emissions concerns. Similarly, a major real estate developer noted their concerns with the placement of FDDG in the Central Maui area citing impacts to future residential development plans.

In addition, the FDDG option requires major transmission line upgrades from the FDDG to the existing transmission system, as well as a redundant transmission line tie-in (to address the N-1 criteria) to the existing 23kV system. Without the NTA/FDDG option, Maui Electric will need to upgrade the existing 23 kV system.

As part of the project analysis, a NTA Business Case was conducted by Accenture and it recommends the CMTD Project as it provides the highest Benefit Cost ratio and provides greater engineering certainty. Based on stakeholder input, a secondary NTA Business

Case will be initiated in first quarter 2017 and is targeted for completion in second quarter 2017. The secondary NTA Business Case will review NTA system level and ancillary benefits, factor in the costs of environmental permitting, land, transmission line and substation interconnection costs (based on location), as well as integrate a risk analysis component.

Based on technical and Business Case analyses completed to date, the Central Maui Transmission and Distribution project (CMTD) provide the most certain path toward ensuring continued reliability and operational flexibility in the Central Maui area. From a cost and technical solution standpoint, other NTA options are more uncertain regarding the potential to provide the necessary remedies before retiring KPP.

The CMTD project is currently in the detailed planning, engineering, and permitting phase, and the Environmental Impact Statement (EIS) process is currently underway with construction scheduled to start in early 2020.

Completing the CMTD and acquiring replacement generation capacity are both targeted for completion by the time KPP is scheduled to retire in 2022. Given the magnitude and complexity of both of these projects, the target KPP retirement date provides a prudent amount of schedule flexibility ahead of the 2024 expiration of KPP's NPDES permit.

---

## GENERATION FLEXIBILITY PLAN

### Hawaiian Electric: Increasing Operational Flexibility of Existing Steam Generators

Hawaiian Electric has implemented a number of initiatives to improve the flexibility of the existing base loaded steam units. The approach reviewed procedures and policies, past studies, and industry guidance. More specifically, instead of just identifying projects that would enhance flexible operations, Hawaiian Electric asked these questions for our evaluation:

- What type of operational needs does the system need?
- What can existing generation do to meet those needs in the short term?  
Some operations will have long term consequences. However, these consequences could be insignificant if plans for modernized generation are implemented.
- What are the limiting factors that prevent such operations?  
Some factors are technical. What can we do to modify operations, procedures, etc. to avoid hitting technical limits?
- Do new or current system conditions make old limitations and policies obsolete?  
What practices, policies, rules can be modified to support flexible operations.
- What projects can be implemented to enhance, support, or improve flexible operations? Or, if necessary, what projects are necessary to make flexible operations possible (issues that could not be resolved with attempts asked above).

In response to these issues, Hawaiian Electric focused on improving flexibility in the following areas:

- Low load operation (improving turndown)
- Ramp rate improvements
- Developing a process to cycle reheat units on and offline

#### Enhanced Low Load Operation

Hawaiian Electric validated low load operations and looked for areas of improvement. During discussions and problems solving events, the company realized that if it could lower unit load even further than initially expected, it could provide nearly the same system benefit as cycling operation, in terms of allowing more variable generation, and at the same time provide system reliability services while minimizing cycling wear and tear on the units.

From that point, the company researched what is the lowest load that the turbine and generators could safely support. From there, what operational practices would need to be changed in order to achieve such low load?

Hawaiian Electric quickly learned that a realistic enhanced low load of 5 MW gross<sup>3</sup> was possible and has various benefits over on and off cycling.

- Results in 2-3MW of net generation. Nearly the same as being offline.
- Less thermal cycling of plant components.
- Will provide ancillary services to the system:
  - Response to system disturbances
  - Frequency regulation
  - Quicker restoration compared to cycling
  - Voltage support
  - Short circuit current
- Depending on the duration of operation, burns the same or less fuel as a unit cycling on and offline.

Following the June 2014 test on Kahe 3, Hawaiian Electric focused on establishing testing schedules and procedures for operating the small reheat units at new low loads. The low load targets were set at 5 MWg.

Again, Hawaiian Electric took a holistic approach to the low load operation. For example, Hawaiian Electric had a long-standing policy to always operate with all burners in service. The requirement was based on maintaining the ability to pick up load and respond to system disturbances. After analyzing those requirements, the company determined that system conditions are now different and the customer is best served by modifying the existing policy and procedures.

In other cases the company examined the technical limits. Steam and turbine metal temperatures had historically been limiting factors. The department explored, tested and implemented a new operating control called hybrid variable pressure operation (VPO). In true variable pressure operation, the boiler and throttle operating pressure is reduced until the turbine governor valves are wide open. Changes in load are then accomplished by changing boiler and throttle pressure.

This type of control has the benefit of improving efficiency and helps minimize thermal stresses on the turbine. However, this type of control is not proper for the Hawaiian Electric system as the units respond to slowly to changing demands or system upsets.

---

<sup>3</sup> Gross MW includes generation used to supply the unit's own electric load. Net load refers the actual export to the system.



With the “hybrid” approach, Hawaiian Electric operates at normal boiler and throttle pressures above 30 MW. When asked to reduce load to less than 30 MW, the Department slides boiler and throttle pressure linearly as load drops. This mode of operations allows the Department to maintain current operating characteristics at normal operating loads but allows the unit to achieve new lower loads while meeting required turbine operating parameters.

The low load operation has the various benefits previously described and has greatly enhanced the ability to add variable generation to the system. Table M-4 shows the magnitude of difference.

Unit	Normal / Historic Low Load	Enhanced Low Load	Change in Minimum Load
Kahe 1	30 MW	5 MW	25 MW
Kahe 2	30 MW	5 MW	25 MW
Kahe 3	30 MW	5 MW	25 MW
Kahe 4	30 MW	5 MW	25 MW
Waiau 7	30 MW	5 MW	25 MW
Waiau 8	30 MW	5 MW	25 MW
Total Reduction in Hawaiian Electric Minimum Load <sup>4</sup>			150MW

Table M-4. Hawaiian Electric Total Reductions in Minimum Loads

### On/Off (Daily) Cycling

Hawaiian Electric also examined the cycling of reheat units. As mentioned, the initial test in June 2014 was an online/offline cycling test. During that test the Department proved that “hot” cycling of the small reheat<sup>5</sup> units could be performed daily, and that the units could start reliably daily. Total start time from initial fires to firm generation is approximately 3.5 hours. Longer shutdowns, such as weekends, result in longer starts.

Hawaiian Electric believes that the focus and immediate needs are best served with the enhanced low load operation for the reasons previously discussed and that is where the focus to date has been. With that said, Hawaiian Electric is confident in the ability to cycle the small reheat units if it becomes necessary. The ability to cycle will revolve around procedure enhancement and practicing shutdown and startup techniques to minimize thermal stresses. The ability to properly estimate when the unit will return to service allows establishing shutdown conditions that minimize startup time and stress. Some unit modifications are being considered to facilitate cycling and improve long term reliability. These projects are not necessary to cycle in the short term but would facilitate

<sup>4</sup> Based on theoretical operation of all six units at new enhanced minimum load. Other system requirements, such as system ramp rates, may or may not allow for all six units to operate simultaneously at the new enhanced low loads.

<sup>5</sup> Kahe units 1–4 and Waiau units 7 and 8 are considered small reheat units. Kahe units 5 and 6 are considered large reheat units.

such operations over time. Projects are to be considered based on benefit, cost, and in consideration of the generation modernization plan.

Hawaiian Electric estimates that the breakeven point between enhanced low load operation and cycling is about five hours based on fuel expenses alone and depending on the specific unit. The breakeven point would be longer than five hours when including maintenance cost and reliability issues.

### Consequences of Low Load Operation and Cycling

Operation at the enhanced low loads does have some consequences. Operationally, the unit is not immediately available for full load operation. With the boiler/throttle pressure reduced and multiple burners out of service the unit needs time to restore to full capabilities. Based on boiler and throttle pressure ramp rate limits the restoration time is 1.5 hours. However, the unit is available for increasing amount of load throughout the recovery period.

Ramp rates are also affected. While operating at the enhanced low loads the units can ramp at the traditional ramp rates but not the new, higher ramp rates achieved as part of the flexible operation initiative discussed in the following section.

In addition, it is expected that maintenance cost will eventually rise do to the cyclic thermal and pressure stresses. However, these thermal and pressure cycles are smaller than if the unit was to be cycled on and offline. Nonetheless, industry evidence shows that maintenance cost associated cycling or larger load following events is expected to increase.

Future maintenance costs are also expected to be measurably higher with enhanced low load or cycling operation. Enhanced low load and cycling operation causes increased pressure and temperature cycling on boiler and turbine pressure components. These cycles increase both in terms of frequency and magnitude. These increased stress cycles result in damage from corrosion fatigue, thermal and mechanical fatigue, creep, stress corrosion crack, and others. For example, hot starting a reheat unit results in thermal quenching of the economizer. In addition, some valves will have increased wear from cycling operation. For example, boiler feed regulating valves and boiler feed pump recirculating valves are expected to have higher maintenance cost associated with increased use at the extremes of their design. With more operation with lower mass flow through the boiler, boiler tube deposition and associated failure events are expected to increase. Essentially, increased flexibility provides immediate benefits to the system but will result in future increases in maintenance expenses.

It should be noted that heat rate (efficiency) is poor during the enhanced low load operation. Generally heat rate is higher the lower the load. However, due in large part to

National Fire Protection Association (NFPA) requirements regarding minimum boiler air flow, heat rate increases exponentially below about 25 MW. This high heat rate affects the system LSFO heat rate.

Cycling operation also affects the heat rate of the units. The fuel used for startup operation causes measured heat rate to increase. Increasing the number of starts on the reheat heat units will also affect system LSFO heat rate.

### Ramp Rates

Hawaiian Electric has also worked to improve the ramp rates<sup>6</sup> of existing generating units. Power Generation had previously tested higher ramp rates. Based on that testing and an understanding of equipment limitations, the following ramp rate improvements were made:

Unit	Old Normal Ramp Rate (MW/Minute)	Future Normal Ramp Rate (MW/Minute)
Kahe 1	2.3	4.0
Kahe 2	2.3	4.0
Kahe 3	2.3	5.0
Kahe 4	2.3	5.0
Kahe 5	2.5	4.0
Kahe 6	2.5	4.0
Waiau 7	3.0	4.0
Waiau 8	3.0	4.0
Waiau 3	0.9	0.9
Waiau 4	0.5	0.5
Waiau 5	3.0	3.0
Waiau 6	3.0	3.0
<b>Total</b>	<b>27.6</b>	<b>41.4</b>

Table M-5. Hawaiian Electric Ramp Rate Improvements

The table above represents a 13.8 MW per minute<sup>7</sup> improvement of steam plant ramp rates. These improved ramp rates represent the ability existing units to respond to changes in wind and or solar generation. The ramp rates for the cycling units were not changed. Waiau 3 and 4 are of an age and material condition that does not support increasing ramp rates. Waiau 5 and Waiau 6 have high ramp rates as a percentage of their size.

<sup>6</sup> Ramp rate is the rate at which generator load can be changed, measured in MW/min.

<sup>7</sup> Assuming all listed units were online at their normal operating modes. During most operating periods all units are not online and increased amounts of variable generation will likely result in more units offline or operating in hybrid variable pressure operating mode.

Kahe 3 and Kahe 4 have modern turbine control systems. This modern control system allows them to operate in what is referred to as “coordinated control”. In this operating mode the turbine and boiler operations are coordinated and allow for improved control of the unit with higher ramp rates. Kahe 1, Kahe 2, and all the Waiiau units operate in “boiler follow” mode. In this mode the turbines respond to demand. The boiler control system senses a change in pressure and fires up/down to correct the pressure variance. In this mode, larger ramp rates challenge the control systems abilities to increase load while maintaining environmental compliance. For that reason they will have a lower ramp rate than Kahe 3 and Kahe 4. Kahe 5 and Kahe 6 turbines have an old analog control system that does not easily accommodate coordinated control and therefore the units also operate in boiler follow.

It should be noted that the new higher ramp rates do not apply while operating in enhanced low load mode. The benefits of the ramp rate improvements only apply at normal operating conditions.

## Conclusion

Flexible operations improvements are critical for the short term ability to adapt and support increased levels of variable generation. Photovoltaic systems have already impacted day time operations. The daily load profile has been altered by the amount of variable penetration on the system during the day. In 2016 there were numerous occasions where one or more small reheat units were dispatched to the enhanced low loads during morning and afternoon hours. Likewise, there were a number of occasions where one or more small reheat units were dispatched to the enhanced low loads during overnight hours to avoid curtailment of wind. As the magnitude of variable generation increases the existing Hawaiian Electric generators will continue to play an important part in maintaining system reliability and stability.

These new operating improvements will not come without cost. Future maintenance costs are expected to rise as the units experience increased amounts of thermal and pressure cycles. These operations are considered short term solutions until better-suited, modernized generation can replace the existing generating units.

## M. Component Plans

### Generation Flexibility Plan

#### Maui Electric Generation Flexibility Plan

Maui Electric has implemented many changes in our generation fleet to increase flexibility and renewable integration. These have previously been described in our System Improvement and Curtailment Reduction Plan (SICRP) and subsequent annual updates. These changes included:

- Implementing the Maui Operation Measures.
- Reducing the number of baseload units.
- Reducing prior run times of KPP units 1 and 2.
- Lowering of the minimums on KPP units 3 and 4.
- Studying and implementing new regulating reserve requirements.
- Automating curtailment through our Automatic Generation Control (AGC) system.
- Low load modifications to DTCC 1.

The existing Maui Electric generation fleet has operating characteristics that are quick starting, flexible, fuel-efficient, and dispatchable to accommodate the integration of existing and additional variable renewable energy resources without significant curtailment.<sup>8</sup> Quick-starting generation has the ability to remain offline until it is required to support the system (such as during a large down ramp event when the wind or solar resources suddenly become unavailable). Other units that may need additional time to start and connect to the system will need a resource to bridge the time required to supply generation (for example, demand response and energy storage). Flexible generation refers to units that can be held offline until called upon for generation, allowing us to maximize variable renewable generation.

#### Roles of Current Generation

**Kahului Power Plant.** Kahului Power Plant consists of four steam units (K1, K2, K3, and K4) that provide firm generation, regulating reserve, system inertia, reactive power and voltage support for Central Maui, and is the primary source of fault current for the 23 kV system. These units burn an industrial fuel oil that is lower cost than diesel. K1 and K2 units were deactivated on February 1, 2014, however, they have been taken off deactivated status in 2016 due to system needs.

**Ma‘alaea Power Plant.** Ma‘alaea Power Plant has two dual-train combined cycle units (DTCC1 and DTCC2). These units provide firm generation, regulating reserve, and system inertia, and can start and provide generation in a relatively short time period. When operated in the dual-train combined cycle configuration, these units are the most efficient generating resources on Maui. DTCC 1 is a must-run generating unit that

---

<sup>8</sup> The thermal generation fleet on Lana‘i and Moloka‘i is comprised of flexible, quick-starting units.

contributes to system security. Modifications are in progress and planned to be completed in January 2017 to allow it to operate at a lower capacity minimum level. This will allow more opportunity to integrate variable renewable energy when available. DTCC2 was changed from a baseload unit to a unit that can be operated in combined cycle or simple cycle mode when there is a capacity need or when renewable energy is not available.

Ma'alaea Power Plant also has fifteen internal combustion diesel units (MX1, MX2, M1, M2, M3, M4, M5, M6, M7, M8, M9, M10, M11, M12, and M13). These units provide firm generation and regulating reserve. These units can start and provide firm generation in a relatively short time period. Five of these units (MX1, MX2, M1, M2, and M3) are quick-starting units that can be used for emergency and as a transition unit to starting a larger diesel unit. (MX1, MX2, M1, M2, and M3 units do not contribute regulating reserves when they are online because they run at top load). These units will remain offline and be available for contribution to system security and system load as needed after other offline non-fossil fuel resources (such as DR and energy storage) have been used to its fullest availability. Generator controls were upgraded on four of the diesel units to enable remote monitoring and operation of the generating units for better response to system disturbances and system demands because of the increase in variable renewable resources on the system.

DTCC1, DTCC2, and M4–M13 units have operating ranges that can ramp up and down to accommodate fluctuations in the availability of variable renewable energy and/or system load.

**Hana.** Hana has two internal combustion diesel units that provide firm generation and primarily provide support to the Hana area during transmission maintenance and system disturbance. These units will continue to be operated to support the Hana area.

**Lana'i-Miki Basin.** Lana'i has a centralized generating station with nine internal combustion diesel units that provide firm generation, frequency response and regulating reserves, system inertia, reactive power and voltage regulation, and the primary source of fault current for the system. These units can start and provide generation in a relatively short time period. Generator control upgrades were completed in 2015 to enable remote monitoring and operation of the generating units. Maui Electric also has an agreement to operate a combined heat and power (CHP) unit that is expected to return to service in 2017. The Lana'i system does not have AGC and, therefore, the demand for electricity is shared equally between the online units in an isochronous mode of operation.

Maui Electric runs a minimum number of baseload units on Lana'i, typically two. The CHP unit can replace one of the two diesel units that provide baseload power for the

## M. Component Plans

### Generation Flexibility Plan

system at Miki basin. When additional units are needed, they are committed in the most economical order given operational constraints.

Maui Electric applied for and is awaiting approval from DOH for modifications to our air permit that allow lower minimum operating levels on the baseload units to accommodate the addition of more renewables to the system.

**Moloka'i–Pala'au.** Moloka'i has a centralized generating station with nine internal combustion diesel units and one diesel combustion turbine that can start and provide firm generation, frequency response and regulating reserves, system inertia, reactive power and voltage regulation, and is the primary source of fault current for the system. These internal combustion diesel units can start and provide generation in a relatively short time period.

Maui Electric currently operates with two baseload units on Moloka'i because this is the lowest number of base loaded units that satisfy our single contingency criteria. When additional units are needed, they are committed in the most economical order given operational constraints. The Moloka'i system does not have AGC; therefore, the demand for electricity is shared equally between the online units in an isochronous mode of operation.

Maui Electric applied for and received approval from the DOH for modifications to our air permit that allow lower minimum operating levels on the baseload units to accommodate the addition of more renewables to the system. In addition, generator control upgrades have been completed that enable remote monitoring and operation of the generating units.

## Hawai'i Electric Light Plan for Increasing Generation Flexibility

Hawai'i Electric Light has analyzed the operation of existing resources and planned resources. The operational plans incorporate the results of consulting work to evaluate optimization of existing resources, and build upon previous cycling and turndown studies (including the outcome of the RSWG studies), Electric Power Research Institute (EPRI) publications, and other industry literature. We have taken a holistic approach to operational flexibility and have incorporated into our operational and planning processes procedures and policies enabling generation flexibility. The present utilization of dispatchable generation reflects substantial changes from past use in order to accommodate increased renewable energy, including variable wind and solar. There is increased offline cycling, increased ramping, and reduced minimum dispatch limit while retaining ramping capability. The more recent generation additions, such as the combined cycle facilities at HEP and Keahole, incorporated flexibility features into their design.

The historical operation of the Hawai'i Electric Light system included a fleet of fast-start generators; these have been leveraged as flexible resources that have proven invaluable in reliable integration of a large amount of wind and distributed solar PV energy.<sup>9</sup>

In the analysis performed after the 2014 PSIP and identified as necessary measures in that filing, security and reliability studies identified the need for increasing contingency reserve requirements of reliable operation of the power system with existing and increasing levels of DG-PV. As part of our action plan, energy storage will be added to the mix of resources to provide.

Hawai'i Electric Light has implemented many changes in the operation and capabilities of existing generation assets, to support increased levels of renewable energy and maintain acceptable cost and reliability.

- Lowering of the dispatch minimums on Hill 5, Hill 6, and Puna Steam to reduce excess energy issues and enable greater acceptance of variable renewable energy.
- Increasing ramp rate and primary frequency response for Hill 5, Hill 6, and Puna Steam to improve contribution to frequency response and regulation.
- Adjusting regulating reserve requirements based on real-time observation of variability: maintain low levels of reserve for quiescent conditions and higher levels of reserve for variable wind and solar conditions.
- Incorporating variable solar and wind forecast into unit commitment decisions.
- Implementing of centrally controlled curtailment for larger distributed solar and FIT projects.
- Adding of remote control curtailment for the Wailuku River Hydro project. Offline cycling of Puna Steam and Hamakua Energy Partners, after confirming (through analysis) that acceptable reliability could be maintained.
- Incorporating dispatch control into the Puna Geothermal Venture expansion, and increasing the potential geothermal capacity by 8 MW.

The results of past security analysis produced minimum criteria for system reliability for generation units. With that information, units not necessary for system security and reliability are subject to economic unit commitment dispatch, with consideration of the incurred daily cycling costs. The present system operation at Hawai'i Electric Light incorporates routine daily cycling of the Hamakua Energy Partners (HEP) combined cycle plant. Puna Steam was, for a period of time, cycled on a seasonal basis: left offline with preservation measures for extended periods and brought back online when needed to ensure adequate capacity. Based on the present low cost of its fuel, Puna Steam can

---

<sup>9</sup> For more details, see Exhibit 11: Generation Flexibility Plan, Docket No. 2012-0212, Hawai'i Electric Light, Inc. Power Supply Plan, filed April 21, 2014.



## M. Component Plans

### Generation Flexibility Plan

economically serve demand provides routine peaking energy in addition to operating to maintain adequate margins.

There have been occasional adequacy of supply issues created through increasing offline cycling. The present operation represents a significant reduction in the number of fossil generation units historically operated and relies more upon cycling. The reliability impacts from the increased cycling of generating units occur due to the increased potential for shortfall from the delay in startup or startup failure, and the reduction of capacity available quickly during periods that Puna Steam is in layup.

In addition to managing online variability (which requires ramping and reserve capacity online), it is increasingly difficult for the System Operator to determine when to start and stop generation due to the increased uncertainty in demand to be served. This is called “unit commitment”. Unit commitment decisions seek to bring the mix of generation online that can reliably meet demand at the lowest cost. The commitment of generation has been complicated by the large amount of variable energy from wind and solar, the latter of which continues to increase. To facilitate operation, state-of-the art forecasting tools are now integrated into the control room. These tools continue to be refined based on site visits from the developer and feedback from the system operators. Nonetheless, there remains a great deal of uncertainty in the forecast, which can lead to under- or over-committing the generation. Under-committing occurs when production is lower or a down-ramp occurs, and may lead to a generation shortfall and the need for supplemental or emergency generation. Over-committing occurs when production is higher than expected, and can lead to inefficient dispatch (higher cost), and may contribute to excess energy conditions requiring mitigation by reducing renewable energy or taking generation offline.

### Expanded Turndown Range

Hawai‘i Electric Light improved the turndown of its steam units to lower loads. Minimum dispatch limits were reduced through various plant modifications including combustion controls and equipment. The following reductions were made from the levels in 2012. The Hill 5 minimum regulation limit was reduced from 9 MW to 5 MW. The Hill 6 minimum regulation limit was reduced from 16 MW to 8 MW. The Puna Steam regulation limit was reduced from 8 MW to 6 MW. The minimum regulation dispatch limits for other significant units are 27/22 MW for Puna Geothermal and 9 MW for Keahole and HEP in single-train. Dispatch limits (continuous operation limits) are typically one MW higher than the regulation limit for most of the resources. In the case of the Puna Geothermal Venture facility, dispatch of the facility is presently unable to meet the requirements for regulation under automatic generation control. They are actively working on increasing remote control capability, following restoration of capacity which

had been lost due to well impacts that occurred during the plant outage following Tropical Storm Iselle.

### **Fast-Start and Peaking Resources**

Existing generation resources provide a significant amount of fast-start, fast-ramping capability. The resources consist of small diesel units and simple cycle gas turbines

For supplemental and emergency purposes, including to cover for forecast errors, Hawai'i Electric Light has available 46.3 MW that can be started in 20 minutes or less, and 29.5 MW from small diesel units that can be brought online in 2.5 minutes or less. These units are increasingly used to cover for start-failure of cycled units and short-term generation needs caused by forecast errors. The availability of these units allows the operator to adjust generation quickly in response to changes in net demand. They are also used to restore under-frequency load shed.

The existing available capacity for fast-start resources is sufficient to meet supplemental reserve requirements.

The System Operators are increasingly using the simple cycle peaking unit CT3 to manage the change in demand created by variable distributed solar. The impact of distributed solar-PV creates a short-term need for generation to meet the increase in demand (morning load rise). Due to the impact of distributed solar, the highest daytime peak can occur any time between 7 and 9 in the morning before PV production begins. When the solar production is uncertain, or when it is predicted to be significant, the system operators will commit CT3 for the short-term need, rather than HEP or Keahole combined cycle train to avoid starting a combined cycle unit for only a short period. Although combined cycle units are more efficient, they take longer to come online. In the case of HEP, under the PPA terms the System Operator may only start each train once per day, so once the unit is started it has to be kept online unless it is not expected to run for the evening peak

### **Frequency Response, Regulation, and Ramp Rates**

Generators and technologies differ in their ability to contribute to essential grid services. To best meet system needs for frequency response, regulation, and ramping, new resources are required to provide these capabilities to maintain system security and reliability. Moreover, where possible, ramping and regulation capabilities must be provided or improved from existing resources. As part of continuous improvement initiatives, ramp rates were increased for all the utility-owned steam units since mid-2012. Increased dispatch range also improves regulation capabilities by allowing a larger contribution of a generator to both up and down reserve.

## M. Component Plans

### Generation Flexibility Plan

As part of its expansion to 38 MW, Puna Geothermal Ventures (PGV) changed its facility characteristics from a passive energy source to one that provides frequency response, voltage response, and dispatch under Automatic Generation Control (AGC). PGV however presently has only limited primary frequency response and capability to operate under AGC. The rate and range of response has been limited both because of controls issues since Tropical Storm Iselle. Hawai'i Electric Light plans to continue working with PGV in increasing its operational flexibility, following its restoration to 34.5 MW capacity (following its deration after Hurricane Iselle) and achieving 38 MW, which is anticipated to be within the next few months.

Analysis including new firm capacity renewable resources assumed that they would provide grid services comparable to similarly sized conventional plants. To achieve 100% renewable generation with acceptable reliability, a renewable resource must provide the system reliability requirements presently met by the generating units at Keahole Power Plant (through a similar operational and technical capabilities and a location near to Keahole) and support east-west power flows and voltages without requiring significant transmission infrastructure.

Future new utility-scale variable generation (such as planned wind plants) will also be designed to incorporate technical and operational capabilities available in present day wind plants, including inertial response, ramp rate control, frequency response, active power control, and disturbance ride-through to contribute to grid operational requirements, mitigate impacts of the variability, and lesson the need for other resources to provide such services.

Because of the impacts of DG-PV, increased contingency response (that is, fast frequency-responding reserves) and fast-ramping regulating reserves are required, plus ride-through capabilities from DG-PV. To meet these needs, an energy storage system with response capabilities in excess of generation capabilities will be added to the system to provide contingency reserves. To meet the faster ramping capabilities, the fast ramp capabilities of the existing combustion turbines will be leveraged.

---

## MUST-RUN GENERATION REDUCTION PLAN

Integrating renewables into our system needs to be accomplished safely and reliably. As discussed earlier, improving the flexibility of the generating fleet is an important piece to integrating larger amounts of variable resources. Maintaining system security is also very important because without it, the ability of the system to withstand sudden disturbances is compromised. System security is maintained by operating the system with sufficient inertia or fast frequency response, or primary frequency response, limiting the magnitude of the contingency event, maintaining adequate contingency reserves and maintaining system fault current; at times requiring the system operator to sacrifice efficiency for reliability.

The approach taken in this PSIP update was to define and determine the amount of technology-neutral ancillary services for meeting reliability criteria instead of relying on must run generating units. This allows other resources to be used to provide the necessary ancillary services to make the system secure if they meet the requirement defined by the analyses. Demand Response programs, Distributed Energy Resources, and fast frequency response storage technologies could be used to provide the ancillary services and would displace the need to run firm generating units which would provide headroom for more renewables on the system. Variable renewable energy resources added in the future will provide upward and downward reserves. Synchronous condensers will also be used to provide reactive power and the required system fault current to operate protective relays in lieu of generating units. Together, this will reduce the system requirement for requiring generating units to be run to make the system safe and reliable.

It's important to note that maintaining a minimum capacity of fault current ensures protective relay schemes will operate. This does not ensure that the system has sufficient fault current to maintain transient voltage stability. The companies must perform analyses to determine an acceptable short circuit ratio (SCR) at critical busses to maintain transient voltage stability. The utility industry has yet to develop a standard for SCR.

Removal of a must run generating unit constraint assumes the resources that provide the fundamental grid services (inertia, frequency response reserves, reactive power, fault current) are online in sufficient quantities to ensure system stability and public and equipment safety. If these resources are not available, system security must be provided by synchronous generators.

The Companies filed a "Value of Services Methodology" in Docket No. 2015-0412 on December 14, 2016 at the Commission's request. This document described the

## M. Component Plans

### Must-Run Generation Reduction Plan

assumptions and modeling methodologies to be used to value each of the grid services pursued by the demand response portfolio in as technology-neutral a manner as possible. The Companies plan to file a Revised DR Portfolio filing in February 2017.

### Hawaiian Electric

The analysis conducted for the Hawaiian Electric system assumed that there would be no must run generating units from 2019 except for HPOWER and AES to comply with current PPA contract terms. The system security analysis was performed on the PLEXOS cases as described in Appendix O: System Security Analysis.

### Hawai'i Electric Light

The analysis conducted for the Hawai'i Electric Light system assumed that there would be no must run generating units from 2020 except for PGV to comply with current PPA contract terms. The system security analysis was performed on the PLEXOS cases as described in Appendix O: System Security Analysis.

Results of the QV analysis indicates that cycling Keahole offline could trigger an overload condition on L6200 for an N-1 contingency. Sensitivity analysis to install synchronous condensers at Keahole did not mitigate the overload condition. Sensitivity analysis was also performed with L6200 operating at a higher ampacity that resulted in no overload condition and no requirements for synchronous condensers at Keahole. The L6200 Transmission Line Rebuild project is in Hawai'i Electric Light's action plan.

### Maui Electric

The analysis conducted for the Maui system assumed that there would be no must run generating units from 2022 when Kahului Power Plant is decommissioned and new generation is added.

The analysis conducted for the Moloka'i and Lana'i systems assumed that there would be no must run generating units from 2020 except for Kahului 3 or 4. Maui's 23 kV system requires 16 MVA of fault current to ensure protective relay schemes will operate.

The analysis conducted for the Moloka'i and Lana'i systems assumed that there would be no must run generating units from 2020.

The system security analyses were performed on the PLEXOS cases as described in Appendix O: System Security Analysis.

---

## ENVIRONMENTAL COMPLIANCE PLAN

### Mercury and Air Toxics Standards (MATS) Compliance Strategy

The MATS rule is applicable only to the steam electric units on Hawaiian Electric's O'ahu system.

The MATS rule required Hawaiian Electric to control and measure particulate matter (PM) emissions as well as fuel moisture content as surrogates for reducing hazardous air pollutants (HAPs), including heavy metals and acid gases, from its oil-fired steam generating units by April 2016. The MATS rule originally required Hawaiian Electric to reduce emissions of HAPs, including heavy metals and acid gases, from its oil-fired steam generating units by April 2015. On November 6, 2013, Hawaiian Electric obtained from the State DOH a one-year extension on the April 2015 compliance date.<sup>10</sup>

To be ready for the April 2016 compliance date, Hawaiian Electric conducted emissions testing for each steam unit on O'ahu that is subject to the MATS PM emission standard. Tests involved measuring PM emissions to confirm the effectiveness and repeatability of potential MATS solutions. Testing throughout 2014 and 2015 allowed Hawaiian Electric to collect data to confirm the accuracy of the MATS solution chosen. As announced in the Companies' January 2016 Update of Fuels Master Plan (FMP),<sup>11</sup> Hawaiian Electric's preferred compliance solution was to utilize a 70/30 blend of low sulfur fuel oil (LSFO) and diesel at Kahe 5 and 6, but to continue using 100% LSFO at Kahe 1-4 and Waiiau 3-8.

After the FMP was filed, additional testing on Kahe 5 and 6 demonstrated that the units can meet MATS requirements using 100% LSFO. This is a departure from Hawaiian Electric's initial concern that all units would have to burn a more expensive 70/30 or 60/40 MATS fuel.

### National Ambient Air Quality Standards (NAAQS)

At this time, NAAQS rules are only expected to impact Hawaiian Electric. It is currently unclear about the necessity of reducing LSFO use and switching to a lower emissions fuel blend to attain the new one-hour for sulfur dioxide level in the vicinity of the Kahe and

---

<sup>10</sup> Hawaiian Electric was granted a one-year MATS compliance extension, which places the compliance deadline at April 16, 2016. A second one-year extension is available to utilities through an Administrative Order that would be issued by the EPA. Based on the evaluation criteria established by the EPA in a December 16, 2011 Policy Memorandum, the second one-year extension must be based on a system reliability assessment and is considered a much more difficult extension to obtain. The MATS compliance date is set forth in Title 40 of the Code of Federal Regulations (CFR), Part 63, Subpart UUUUU, National Standards for Hazardous Air Pollutants: Coal-and Oil-fired Electric Utility Steam Generating Units.

<sup>11</sup> The FMP is filed semi-annually, currently in Docket No. 2012-0217. It is used to continually update the Commission and other interested parties of the Companies' fuel strategies and procurement timelines.

## M. Component Plans

### Environmental Compliance Plan

Waiau generating stations. The best case scenario, absent the use of natural gas, would be using 100% LSFO. The Companies currently believe the worst-case scenario would be blending 40% LSFO with 60% lower sulfur fuel. For planning purposes, the Companies used a conservative approach and assumed the 40/60 blend will be required.

The Clean Air Act (CAA) requires the EPA to set NAAQS for pollutants considered harmful to public health and the environment. The six “criteria” pollutants are carbon monoxide (CO), lead, nitrogen dioxide (NO<sub>2</sub>), ozone, PM, and SO<sub>2</sub>. The CAA also requires the EPA to review the NAAQS every five years and to revise the NAAQS to reflect the latest scientific information on the impacts of air pollution on public health and the environment.

In 2010, the EPA revised the NAAQS for SO<sub>2</sub> and NO<sub>2</sub>, making them more stringent. The compliance requirements for particles less than 2.5 micrometers in diameter (PM<sub>2.5</sub> or “fine particles”) were also made more stringent. Based on the Companies’ preliminary analysis, the new SO<sub>2</sub> standard poses the greatest compliance challenge. Even though NAAQS potential emission reduction requirements for existing units have been pushed back from the original deadline of 2017 to 2025, the Companies have to consider a variety of compliance options for its long-term fuel procurement strategy and planning assumptions. Lowering sulfur emissions to the required levels could be achieved by either switching to a lower sulfur fuel, or by installing air quality control equipment (backend controls).

The Companies believe that the most cost effective way to meet the future NAAQS compliance requirements is to use a fuel that meets the requirements as opposed to installing costly backend controls. LNG has emerged as a viable option that will comply with air emission standards, while also substantially lowering fuel costs compared to petroleum-based options. A lower-cost, cleaner-burning LNG will result in cost-savings to customers.

## New Source Review (NSR) and New Source Performance Standards (NSPS)

NSR and NSPS are CAA programs that may have an impact on the future operation of fossil based generation at Hawaiian Electric, Maui Electric and Hawai‘i Electric Light. These programs specifically target older, fossil fuel burning units because they generate more air pollution. EPA and DOH require modern pollution control and monitoring equipment to be added to an existing stationary unit if it undergoes certain changes in operation or there is a major modification to the unit.

The NSR program requires existing facilities to improve emission control performance as technology improves over time as older equipment needs to be modified and results in a significant emissions increase. NSR requires the entity to go through a permitting process

with EPA and DOH to, among other things, identify the best available control technology that will be used to reduce and monitor emissions. The NSPS program establishes limits for how much of a regulated pollutant can be emitted from new or recently modified units in certain source categories, such as boilers, combustion turbines, and stationary compression ignition and reciprocating internal combustion engines. The NSPS emission limits apply to existing units where there is a physical change or change in the method of operation that increases the amount of an air pollutant currently emitted or that adds emissions from a new air pollutant.

Some of the major projects required to continue to run older units at Hawaiian Electric, Maui Electric, and Hawai'i Electric Light could require add-on pollution control to ensure the units emit fewer emissions as they age. The costs associated with emissions control programs will be considered, as units require major modifications to continue to operate in the future.

## Greenhouse Gas (GHG) Regulations

State of Hawai'i Act 234 requires a statewide reduction of GHG emissions by January 1, 2020 to levels at or below the statewide GHG emission levels in 1990. The state GHG rules became effective on June 30, 2014, and require all entities that have the potential to emit GHGs in excess of established thresholds to reduce GHG emissions by 16 percent below 2010 baseline emission levels by January 1, 2020. Affected facilities were required to submit an Emissions Reduction Plan (EmRP) to the DOH for approval by June 30, 2015.

Hawaiian Electric, Maui Electric, and Hawai'i Electric Light have a total of eleven facilities affected by the state GHG rule. Together, these facilities account for almost 56 percent of the 2010 baseline emissions from all affected facilities. Hawaiian Electric made use of the partnering provisions in the DOH GHG rule to prepare a single EmRP that covers all eleven of the Company's affected facilities, and has committed to a 16 percent reduction in GHG emissions company-wide. Hawaiian Electric submitted the Company's EmRP to the DOH on June 30, 2015. The DOH will incorporate the proposed facility-specific GHG emission limits into each facility's source permit based on the 2020 levels specified in Hawaiian Electric's approved EmRP following DOH approval.

As part of a negotiated amendment to the Power Purchase Agreement (PPA) between AES Hawai'i and Hawaiian Electric, Hawaiian Electric has agreed to include the AES Hawai'i coal-fired power plant on O'ahu as a partner in the Company's EmRP. Similarly, with the planned acquisition of the HEP facility by Hawai'i Electric Light, the GHG emissions from the HEP facility will also be addressed in the Company's EmRP. Both the AES PPA amendment and the HEP acquisition are subject to Commission approval, so including these facilities in the Company's EmRP will be done at a following



## M. Component Plans

### Environmental Compliance Plan

Commission approval. Hawaiian Electric is working with the DOH on the timing of the EmRP modifications to address these changes in the partnership.

As part of President Obama’s Climate Action Plan, the EPA was directed to adopt GHG emission limits for new and existing EGUs. The EPA issued the final federal rule for GHG emission reductions from existing electric generating units – also known as the Clean Power Plan – on August 3, 2015. The Clean Power Plan set interim state-wide emissions limits for existing EGUs operating in the 48 contiguous states that must be met on average from 2022 through 2029; final limits will apply from 2030. On February 9, 2016, however, the U.S. Supreme Court granted a stay of the Clean Power Plan pending resolution of several challenges to the rule until several petitions for review in the U.S. Court of Appeals for the D.C. Circuit Court can be heard and a decision is rendered.

The final Clean Power Plan did not set forth guidelines for Alaska, Hawai‘i, Puerto Rico, or Guam because the Best System of Emission Reduction established for the contiguous states is not appropriate for these locations. The EPA indicated its intent to work with the governments for Alaska, Hawai‘i, Puerto Rico, and Guam to gather additional information on emissions reduction measures available in these jurisdictions, particularly with respect to renewable generation. Given the recent Supreme Court decision and pending further action by EPA and federal courts, the timing for establishing Federal GHG emission reduction requirements that may affect Hawaiian Electric’s power plants is uncertain.

## 316(b) Fish Protection Regulations

Section 316(b) of the Clean Water Act requires that National Pollutant Discharge Elimination System (NPDES) permits for facilities with once-through cooling water systems to ensure that the location, design, construction, and capacity of the systems reflect the best technology available to minimize harmful impacts on the environment. Most impacts are to early life stages of fish and shellfish that become pinned against cooling water intake structures (impingement) and are drawn into cooling water systems and affected by heat, chemicals, or physical stress (entrainment).

The EPA issued the final 316(b) fish protection rule on May 19, 2014. This rule titled, *Final Regulation to Establish Requirements for Cooling Water Intake Structures at Existing Facilities*, applies to Hawaiian Electric’s Honolulu, Kahe, and Waiau steam electric generating stations. The Kahe and Waiau facilities are required to comply with the impingement and entrainment standards. The Honolulu facility, because of its lower actual intake water flow when operating, may have to comply with only the impingement standard. Honolulu is currently deactivated, but will have to comply with the 316(b) fish protection rule before it can be reactivated.

The final regulation does not specify the best technology available (BTA) standard for entrainment, but states that “the Director must establish BTA standards for entrainment for each intake on a site-specific basis.”<sup>12</sup> In Hawai‘i, the “Director” is the Director of the Hawai‘i’s DOH.

Significant studies at Kahe and Waiau need to be completed before the DOH can make a final determination of the technology requirements for the affected facilities. Six years of impingement and entrainment data have been collected at Kahe and Waiau and will be used to complete the required studies for these facilities. A preliminary review of the data indicates that closed-cycle cooling (CCC) or cylindrical wedgewire screens will not be required to comply with the 316(b) rule, but fish-friendly traveling screens and fish-return systems may be required.

No firm deadline for compliance is specified in the final rule. Facility-specific compliance schedules will be developed based upon the results of the required studies, in consultation with DOH, and in coordination with the facilities’ NPDES permit cycles.

NPDES compliance also impacts Maui Electric’s Kahului Power Plant (KPP). As discussed in the Fossil Generation Retirement Plan, Maui Electric plans to retire KPP’s generating units no later than November 2024 in accordance with the compliance plan as approved by the DOH in July 2015.

---

<sup>12</sup> §125.94(d), page 538.

---

## KEY GENERATOR UTILIZATION PLAN

This discussion recognizes the unique economic and operational challenges that exist for key O‘ahu and Maui generating units.

### AES Hawai‘i (AES)

AES is a 180 MW coal-fired power plant serving O‘ahu. In November 2015, Hawaiian Electric entered into an Amendment No. 3, for which Commission approval has been requested. If approved by the Commission, Amendment No. 3 would increase the firm capacity from 180 MW to a maximum of 189 MW until the end of the existing PPA term.

The existing PPA between AES and Hawaiian Electric expires on September 1, 2022. The PSIP assumes that the AES PPA is not renewed as of its expiration date.

### Kalaeloa Energy Partners (KPLP)

KPLP is a combined-cycle combustion turbine generator that currently operates on LSFO. As shown in its Adequacy of Supply report filed April 11, 2014, in the absence of new capacity, Hawaiian Electric needs KPLP’s capacity of 208 MW to meet the generating system reliability guideline. In the absence of KPLP, it is estimated that there would be a reserve capacity shortfall of about 175 MW.

Hawaiian Electric and Kalaeloa are in negotiations to address the PPA term that ended on May 23, 2016. The PPA automatically extends on a month-to-month basis as long as the parties are still negotiating in good faith. The month-to-month term extensions shall end 60 days after either party notifies the other in writing that negotiations have terminated. On August 1, 2016, Hawaiian Electric and Kalaeloa entered into an agreement that neither party will give written notice of termination of the PPA prior to October 31, 2017. The KPLP Facility is over 24 years old and will require maintenance that is sufficient to allow the facility to continue to operate with its high degree of reliability over an extended PPA term. This is being considered in the negotiations.

At an appropriate price and with appropriate operating flexibility, KPLP represents a viable future generator for the O‘ahu power system in the future. The KPLP facility is expected to be a viable generator in the future. Because KPLP is an independent power producer (IPP), it is impossible to identify its value in the future without a finalized contract identifying pricing, operating flexibility, and other parameters.

## Campbell Industrial Park Combustion Turbine No. 1 (CIP CT-1)

CIP CT-1 is a combustion turbine that currently operates firing biodiesel. It is the type of generating unit that is compatible and complementary on a power system with increasing amounts of variable renewable generation. CIP CT-1 provides offline reserve, online spinning reserve, and can be turned on and synchronized to the grid within 22 minutes. It can also be readily turned off to accept more variable renewable generation onto the grid. When operating, it contributes a relatively high level of system inertia, can help manage system frequency by responding to minute-to-minute load demand control signals, and can ramp up rapidly to offset rapid down ramps of variable renewable generation.

The fuel efficiency of CIP CT-1 is lower than the AES and KPLP units. For example, at maximum load, its fuel efficiency is about 11,700 Btu/kWh-net. Kahe 6 has a fuel efficiency of about 10,050 Btu/kWh-net at full load. In combination with the higher cost of biodiesel compared to LSFO, CIP CT-1 is the highest cost generator on the O‘ahu power system.

Once the Schofield Generating Station (SGS) is in service first quarter of 2018, CIP CT-1 will switch to using diesel as its normal operating fuel. The biodiesel that would have otherwise been used at CIP CT-1 will subsequently be used in the new SGS engines. Pacific Biodiesel supplies the biodiesel currently used in CIP CT-1 via a contract that has a minimum purchase amount of two million gallons per year. This contract expires in November 2017.

Whether operated on diesel or biodiesel, CIP CT-1 represents a vital resource for the O‘ahu system because of its operating characteristics. The frequency with which CIP CT-1 is operated will depend on its relative fuel cost and system conditions.

## Other Generating Units Owned and Operated by Hawaiian Electric

With a mandate for 100% RPS by 2045, we envision declining use of oil-fired thermal generating units. Thermal generation is, however, desirable to accommodate cleaner and less price volatile LNG. They will also provide strategic use of liquid biofuels that allow the thermal units to “back up” the variable renewable energy and energy storage systems in those situations when there is no alternative to meet system demand.

## Maui Electric Key Generation Units

These units provide benefits to the Maui system, including system security, or flexibility.

- Dual-train combined cycle units: high efficiency, regulating reserves, contingency reserves.

## M. Component Plans

### Key Generator Utilization Plan

- Combustion turbines: operational flexibility through startup availability and dispatch.
- Small diesel internal combustion engines (MX1, MX2, M1, M2, M3): quick-starting
- Large diesel internal combustion engines (M10, M11, M12, M13): operational flexibility through startup availability and dispatch. It is also anticipated that the small and mid-size diesel units will be operated very infrequently, as they will be designated to operate during peak load periods or when variable renewable resources are unavailable.

## Hawai'i Electric Light Key Generation Units

The Puna Geothermal Venture facility provides firm capacity renewable energy, and will continue to be a significant resource towards renewable energy goals for the foreseeable future.

The dual train combined cycle units at Keahole and HEP provide benefits that include system security, fuel efficiency, and fuel flexibility. These resources have flexible operational characteristics, can cycle offline, and used economically to serve demand.

The steam units provide excellent system stability and primary frequency response, and with the present modifications, good dispatch range and ramping capability. The minimum dispatch limit (in MW) is lower than combined-cycle units. The three steam units are presently the lowest cost resources to serve demand because of the low cost of IFO fuel. They are economically serving demand now and for the near term, if the fuel costs remain low compared to alternative available resources. The units, however, are inefficient and not expected to remain cost-competitive with higher fuel costs; they are not candidates for switching to more expensive renewable energy fuels, instead are assumed to be candidates for decreased operation or retirement with the addition of renewable resources.

The fast-start diesels and simple-cycle combustion turbines, which have played a large part in the integration of the present high levels of variable renewable energy and support the amount of offline cycling and low online reserves of today, will continue to play important roles in providing fast replacement reserves and supplemental reserves for forecast errors, ramping events, forced outages (including failed start), and other short-term and emergency energy needs.

---

## OPTIMAL RENEWABLE ENERGY PORTFOLIO PLAN

### Hawaiian Electric's Renewable Energy Portfolio Plan

Hawaiian Electric's analysis of optimal renewable portfolio plans begins with Chapter 3: Analytical Approach that describes theoretical least-cost plans for individual islands (O'ahu, Maui, and Hawai'i Island) and interisland interconnected plans optimized by E3's RESOLVE model. The Companies used the PLEXOS model to analyze a subset of cases based on E3's optimized plans as described in Chapter 4: Analytical Results. The financial evaluation of the core cases is in Chapter 5: Financial Impacts.

### Maui Electric's Renewable Energy Portfolio Plan

Maui Electric's analysis of optimal renewable portfolio plans begins with Chapter 3: Analytical Approach that describes theoretical least-cost plans for individual islands (O'ahu, Maui, and Hawai'i Island) and interisland interconnected plans optimized by E3's RESOLVE model. The Companies used the PLEXOS model to analyze a subset of cases based on E3's optimized plans as described in Chapter 4: Analytical Results. The Companies used PLEXOS to develop optimized resource plans for Moloka'i and Lana'i which is also described in Chapter 4: Analytical Results. The financial evaluation of the core cases is in Chapter 5: Financial Impacts.

### Hawai'i Electric Light's Renewable Energy Portfolio Plan

Hawai'i Electric Light's analysis of optimal renewable portfolio plans begins with Chapter 3: Analytical Approach that describes theoretical least-cost plans for individual islands (O'ahu, Maui, and Hawai'i Island) and interisland interconnected plans optimized by E3's RESOLVE model. The Companies used the PLEXOS model to analyze a subset of cases based on E3's optimized plans as described in Chapter 4: Analytical Results. The financial evaluation of the core cases is in Chapter 5: Financial Impacts.

## M. Component Plans

Generation Commitment and Economic Dispatch Review

---

# GENERATION COMMITMENT AND ECONOMIC DISPATCH REVIEW

The Generation Commitment and Economic Dispatch Reviews are similar for all three operating utilities.

## Prudent Dispatch and Operational Practices

Our unit commitment and economic dispatch policies are based on safe and reliable operation of the system, minimizing operating costs, and complying with contractual and regulatory obligations. The daily generation dispatch process is illustrated in Figure M-1.

With increasing amounts of distributed solar, large amounts of wind power, and increased offline cycling, state-of-the-art forecasting tools have been integrated into the control room. These tools are used to inform unit commitment decisions with forecast power production, variability, and indication of uncertainty in the forecast. There remains a great deal of uncertainty in the forecast, however, which can lead to under- or over-committing the generation. Under-committing occurs when variable production is lower than forecast or is more variable than expected; and may lead to a generation shortfall or underfrequency load-shedding; and need for supplemental or emergency generation. Over-committing occurs when variable production is higher than forecast or more variable than expected and may lead to excess energy and over-frequency, which depending on severity can cause system disturbances, the need to cut back output from renewable resources, and possible operation below minimum dispatch limits.

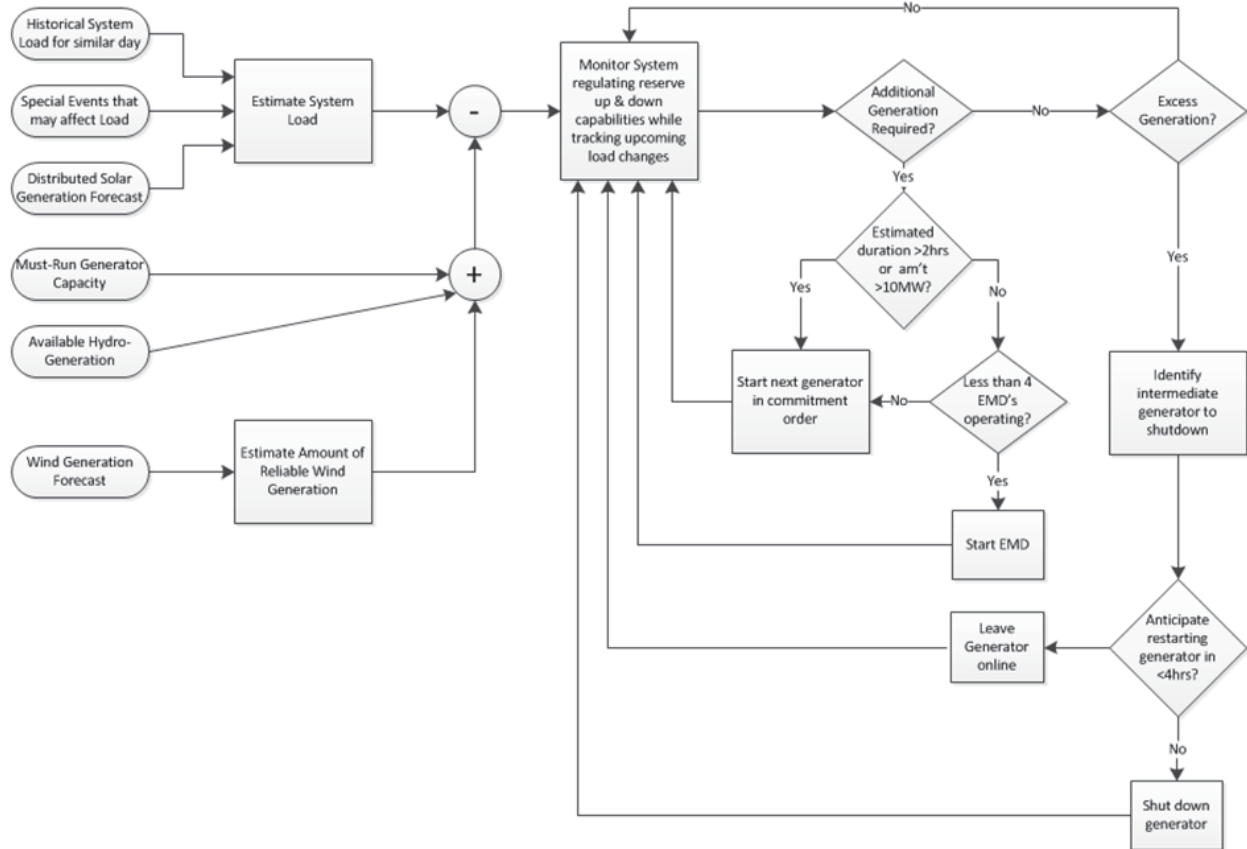

Figure M-1. Daily Generation Dispatch Process

Maui Electric and Hawai‘i Electric Light have integrated its state-of-the-art wind and PV forecasting into the control room, which is used for the daily unit commitment decisions. The amount of online reserves carried is adapted in real-time based on the observed variability of the net demand, primarily driven by wind and solar. Unit commitments are based on economic dispatch, subject to the system security constraints, contract requirements for minimum purchase (such as PGV’s schedule), unit limits, and must-take energy. A factor in unit commitment is the duration of the load to be served. With the increase in DG-PV, a shorter day peak occurs during which it may be more economical to start up a faster-starting but less-efficient resource (such as a simple-cycle turbine).

The Companies must also evaluate whether to return deactivated units to service, such as Hawai‘i Electric Light’s Puna Steam unit.

Additional projects are being developed that will further integrate the forecasting, services, and visualization into the EMS and provide additional control of distributed energy resources. In the future, the unit commitment decisions will incorporate net-demand forecasts, which include the forecast wind and solar production and demand response options. For supplemental frequency control and reserves, new resources will



## M. Component Plans

Generation Commitment and Economic Dispatch Review

be integrated into the EMS, including storage, demand response, and response capabilities from variable resources.

### Minimizing Ancillary Services Costs

The process to identify system security constraints, and the combinations of resources that can be used to meet them, is:

- Determine system constraints.
- Identify the resource mix that meets each of them.
- Select the lowest-cost combination of resources to operate.

For all three operating utilities, additional security constraints are imposed with increased concentrations of variable renewable resources. Therefore, the projected increase in DG-PV may have an impact on ancillary service costs. We will continually evaluate the economics of using existing resources to meet ancillary services and system security requirements versus meeting those needs with alternative resources (including energy storage and demand response).

### Maximizing the Use of Available Renewable Energy

The commitment and dispatch of renewable energy resources depends upon the contract terms for those resources and whether or not the system operator has visibility and control over the generation. If the resource can be economically dispatched, it is put under automatic generation control (AGC), and its output is determined by its marginal cost relative to the marginal cost of other resources. Examples of this type of renewable resource may include geothermal, generating units using renewable biofuels, waste-to-energy projects, and other “firm” renewable projects. In the PSIP action plans, dispatchable renewable energy, on systems where it is available, has been identified as providing value by displacing maximum amount of fossil fuels through the high capacity factor. However, these types of resources are not readily available on O’ahu unless procured through interconnection to other islands.

Variable renewable energy projects have been contractually treated as must-take, variable energy. These are accepted regardless of cost, but their output is reduced as needed when all intermediate units are offline and there remains excess energy production. In this case, the system operator curtails the output of variable energy providers to the degree necessary to keep the system in balance and provide response reserves. Most curtailments are partial – the output is limited, but the resource is not restricted to zero output. When excess energy necessitates curtailment, it is performed in

a manner consistent with the PPAs associated with the affected resources and in accordance with a priority order established by the system operator.

In addition to excess energy situations, curtailments can also be required for system constraints such as line loading, phase angle separation, line maintenance, and frequency impact from power fluctuations. Curtailments for system constraints are applied to the resources as needed to address these constraints; they are not subject to the priority order used for excess energy curtailments. Curtailments are also performed at the request of wind plants for wind conditions, and equipment issues.

The vast majority of DG-PV is not visible or controllable by the system operator. These resources serve demand ahead of all other resources. Additional growth in DG-PV is forecast to cause increased curtailments of utility-scale variable renewable resources, unless DG-PV is required to provide the visibility and control to the system operator.

As the islands evolve to ever increasing levels of renewable energy, the ability to treat any type of energy as “must take” is increasingly limited in the absence of storage. The islands serve only the demand on the island systems and cannot export excess production as is done in other interconnected areas. Accommodating the renewable resources will displace existing generation that provided dispatchable energy, adjusted to meet demand, and many other characteristics to keep the power system stable and operable. These capabilities to adjust output to serve demand, respond to frequency, regulate voltage, and other stability factors will be increasingly relied upon from variable and firm renewable resources as the systems are transformed to economically and reliably serve the energy needs of the future with 100% renewable energy. This increasing contribution to grid management will require changes to both procurement terms and technical and operational capabilities of all renewable resources, including distributed energy resources (DER).

## Energy Management Systems (EMS)

The operation of the system is facilitated by use of a centralized Energy Management System (EMS). The EMS provides the system operator with constantly updated, real-time information about the operational state of the system. There are three key applications within the EMS:

- Supervisory Control and Data Acquisition (SCADA)
- Real-Time Automatic Generation Control (AGC)
- Real-Time State Estimator

Currently, Moloka‘i and Lana‘i do not have AGC capability because of their small size, and instead rely upon isochronous control units for frequency regulation.

## M. Component Plans

### Generation Commitment and Economic Dispatch Review

All three operating utilities routinely update the EMS hardware and software platforms for each system to ensure reliable operation, incorporate new industry developments (such as protocols and system security measures), and maintain support from EMS vendors.<sup>13</sup> With the transformation of the utility systems, additional interfaces are required to the EMS for control of distributed generation and new types of resources (such as storage, demand response integration, and variable generators which have varying levels of reserve depending upon set point and available resource). This will require modifications to the interface, new controls, and modeling of the resources within AGC.

To accommodate the migration to a smart grid network and integration of new resources as well as the use of the communications protocols to support this, the Companies are hardening the security of their EMS systems. Hawai'i Electric Light has tested MPLS communication to a remote terminal unit from a secured EMS network.

Additional applications are being developed to facilitate the dispatch decisions and system management with the changing resource mix. As one example, a study indicated the need to have dynamic allocation of circuits to meet the requirements of the underfrequency scheme, due to the impact of distributed solar on the net demand on each circuit. In 2016 an adaptive underfrequency load-shed application for the Hawaii Electric Light System was designed and the implementation is near completion. This scheme assigns circuits to underfrequency load-shed tiers in real-time, reflecting the telemetered demand on each circuit and total load-shed quantity needed at the time. The scheme required deployment of newer relaying equipment at the various distribution substations, to support the adaptive scheme. Testing will begin in the first quarter of 2017.

## System Dispatch and Unit Commitment

Unit commitment and dispatch decisions are based upon several factors:

**Safety.** Our dispatch of generating resources is always subject to ensuring the safety of personnel and the general public.

**Reliability.** Dispatch and unit commitment must adhere to system security and generation adequacy requirements.

**Contractual Requirements.** Dispatch and unit commitment must adhere to contractual constraints.

---

<sup>13</sup> We operate EMS systems from two different vendors, *Alstom* at Hawai'i Electric Light and Maui Electric, and *Siemens* at Hawaiian Electric.

**Cost.** After meeting all the forgoing requirements, we commit and dispatch units based on their marginal cost, with lower-cost units being committed and operated before higher-cost units.

When determining the unit commitment and dispatch of generating units, we do not differentiate between dispatchable IPPs and utility-owned assets, nor does the daily unit commitment modeling tool input data differentiate units by ownership. Certain generators do receive a form of priority of energy being accepted onto the system based on the location of the generator, its characteristics, or the contractual obligations unique to the resource.

The acceptance of energy for dispatch is in the following order of preference:

**Distributed Generation:** Distributed generation resources receive preferential treatment as “must take” regardless of their economic merit for system dispatch. At the present time, we have no control over, or ability to curtail, the majority of distributed generation.

**Scheduled Contractually Obligated Generation:** These resources are preferentially treated by contract. They are used to serve customer load regardless of their economic merit for system dispatch. Scheduled energy from these resources is taken after distributed generation, but ahead of all other resources, including variable energy providers.

**Contractually Must-Run, Dispatchable Generation:** The resources cannot be cycled offline and therefore the minimum dispatch level of these resources are preferentially treated; the energy is accepted from these resources regardless of cost, except during periods of maintenance.

**Generation to Meet System Security Constraints:** These resources provide energy at least at their minimum dispatch limit ahead of other resources, similar to contractual must-run and scheduled generation, plus an amount of reserve capability to provide down regulation. However, once dispatched, the continued operating status of these resources is subject to continual evaluation of their costs relative to other alternative resources that may become available at a lower cost, except where it is required by contract.

**Variable Energy:** Variable energy is accepted on the system, regardless of cost, after distributed generation, scheduled energy purchases, and continuously operated generation. This energy is accepted regardless of cost and thus presents a constraint on optimized (lowest) cost. If the energy cannot be accommodated because of low demand, curtailment of the resource is ordered according to an established and approved priority order. As stated earlier, variable energy will increasingly be treated as dispatchable and contribute to grid management. This will require additional EMS interfaces.

## M. Component Plans

### Generation Commitment and Economic Dispatch Review

**Dispatchable Resources:** Energy from dispatchable resources is taken on the basis of relative cost (economic dispatch). Resources with the lowest variable energy (fuel and O&M) cost will be committed ahead of resources with higher variable costs. Online resources with lower incremental costs will be dispatched at higher outputs ahead of resources with higher incremental costs. The units operated routinely to meet demand, but cycled offline during minimum demand periods, are described as intermediate units. Short-term (daily) unit commitment decisions do not consider fixed costs associated with these resources because the fixed costs will be incurred regardless of whether or not the unit is operated.

**Compliance:** Permit restrictions or requirements may affect the operation of generation units.

**Generator Availability:** Generators may be out of service for planned maintenance or unplanned reasons.

**Transmission Constraints:** Transmission and distribution maintenance plans.

**Variable Forecasts:** Operational decisions may be different based on wind and solar forecasts versus perfect knowledge of the resource.

**Weather:** Conditions or other risk conditions may require adjustment of the generation mix to provide additional security margin.

**Distributed Energy Resources:** At present, visibility and control of distributed energy resources is limited to only larger facilities and FIT projects. As with utility-scale variable generation, DER will be increasingly integrated into the EMS, including monitoring and control capabilities.

**Adaptive Underfrequency Load-Shedding:** This new application is being developed to enable effective load shed protection schemes under high DG-PV penetration. With increasing amounts of self-generation, the available demand for underfrequency load-shed on each circuit is highly variable and dependent upon solar PV production. The amount of load that must be shed is dependent upon net system demand and contingencies. As mentioned above, a new application on the EMS is being implemented at Hawai'i Electric Light to assign circuits to the load-shed scheme stages dynamically, based on telemetered available circuit demand and the total system net demand. This effort required modifications to the EMS and deployment of new relay technology at various distribution substations. The project is nearing completion and will begin testing in early 2017.

## Utilization of Energy Storage and Demand Response

Energy storage and demand response (DR) programs can provide the system operator with a flexible resource capable of providing capacity and ancillary services. To provide the system operator with appropriate control and visibility, energy storage assets are equipped with essentially the same telemetry and controls necessary to operate generating units. DR used for providing regulating reserves and contingency reserves is also equipped with appropriate telemetry and controls. The specific interface requirements depend upon whether the storage device or DR resource is responding automatically, or is under the control of the system operator. The DR Management System (DRMS) and the Energy Storage Management System (ESMS) is interfaced with an EMS.

For storage or DR that is integrated into the EMS, telemetry requirements include:

- Real-time telemetry for storage that indicates the charging state, the amount of energy being produced, and the device status.
- Control interface to the EMS to enable the increase and decrease of energy output from the storage asset, and for energy input to the storage device for charging.
- Real-time telemetry for DR indicating the breaker status, switch status, and load.
- Control interface to the EMS to configure settings for response to local criteria (for example, underfrequency) or to provide direct remote trip or dispatch control by the system operator.

Storage may also be required to respond to local signals. For example, storage may need the capability to respond to a system frequency change in a manner similar to generator governor droop response, which may be used for a contingency reserve response or for frequency responsive regulating reserve. Another example of local response includes the ability of the storage to change output (or absorb energy) in response to another input signal from a variable renewable energy resource to provide “smoothing” of the renewable resource output.

Short-duration storage is a limited energy resource. This introduces the need for the system operator to be informed regarding the storage asset’s charging state, and the need to ensure that the integration and operation of these resources allows for replacement energy sources before the stored energy is depleted. This replacement could be in the form of longer-term storage or generation resources. For the value of DR to be realized in providing a particular grid service, once called, the load cannot return to the system until after a specified time, which is dependent on the type of grid service being provided by the DR resource. Accordingly, the system operator similarly requires information regarding the status of DR, particularly as it relates to the state of the response after an event has been triggered.

## M. Component Plans

Generation Commitment and Economic Dispatch Review

### Visibility and Transparency in System Dispatch

A high level review of the websites of various independent system operators (ISOs) including PJM (central east U.S.), Midwest ISO (MISO), California ISO (Cal ISO), and the Electric Reliability Council of Texas (ERCOT), shows the following operational information commonly being displayed (along with ISO energy market-specific information such as locational marginal pricing):

- Real time daily demand curve showing actual and forecasted demand, updated at least hourly.
- Hourly wind power MW or MWh being produced and forecasted.
- Other historical renewable energy production in MW (Cal ISO).
- Available generation resources.

Our Renewable Watch site<sup>14</sup> (branded as REWatch), available for our service territories, currently displays the following information, with data refreshed every 15 minutes:

**Net Energy System Load.** The system load served by generators on the “utility-side” of the meter including those owned by the utility and by IPPs.

**Gross System Load.** The net system load plus estimated load served by DG-PV on the customer side of the meter.

**Solar Irradiance Data.** This data is measured in different regions of the island, which are used as input to calculating the estimated load served by DG-PV.

**Wind Power Production.** Total megawatts of wind power being produced by the various IPP-owned wind facilities selling electricity to the Companies.

We continue to enhance the information available on Renewable Watch and other public displays on our Company website. The information on the REWatch will be supplemented with additional information showing for the previous hour the percentage of the energy supplied by the different resources (IPPs, renewables, and utility-owned generating units). A historical archive of the percentage of the energy produced by each of the resource groups for the previous 24-hour period will be maintained so that the customer can view the changes over time.

These enhancements will address the Commission’s objectives of showing the significant use of non-utility generation and renewable resources, most of which (with the exception of our combustion turbine generation CIP CT-1) uses biofuels and are IPP-owned.

In addition, we also make public a description of our economic dispatch policies and procedures via a posting on our website. Combined, the enhancements to our website

---

<sup>14</sup> <https://www.hawaiianelectric.com/clean-energy-hawaii/integration-tools-and-resources/renewable-watch>.

and the sharing of our dispatch policies and procedures increase visibility and transparency of how generating resources are being dispatched on the power grid.

Our generating unit commitment and dispatch of the generating units is based on the objective of incurring the least cost to the customers while continuing to maintain system reliability. With the introduction of increasing amounts of renewable resources, it has become more important to minimize the use of fossil fuels and contend with the dynamic system changes that occur from the new resources so that reliability can be maintained.

A screenshot from the Renewable Watch–O‘ahu website is shown below in Figure M-2 to provide an example of the variability of the renewable energy resources.

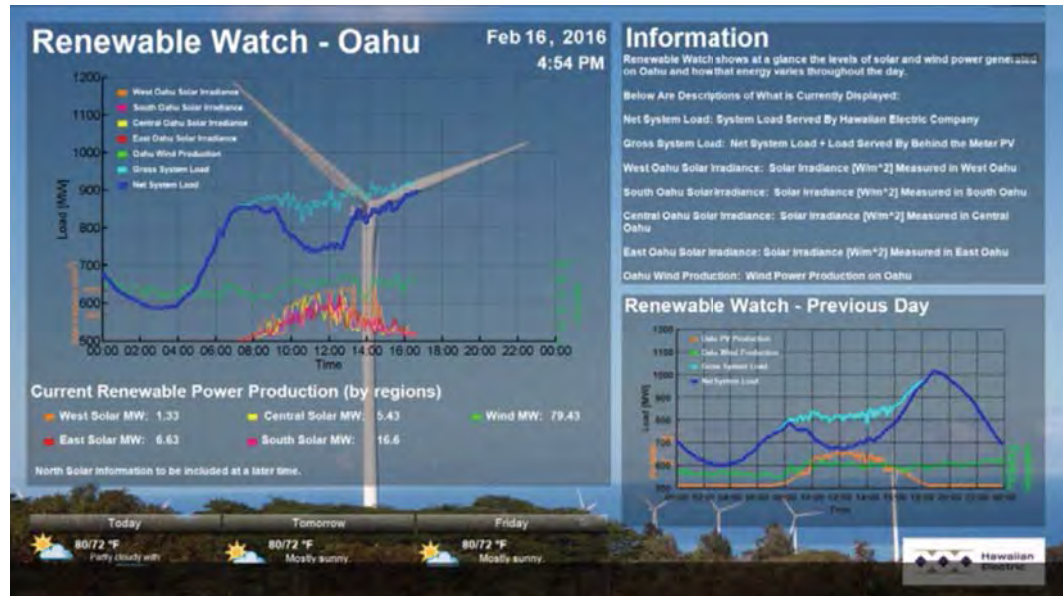

Figure M-2. Renewable Watch–O‘ahu Website Screenshot

The new visualization tools have been under development for each respective systems over the past few years, and are presently integrated to enlighten site visitors. We understand the importance of visibility and transparency of the economic commitment and economic dispatch of resources to show customers that a real effort is being made cost-effectively use fossil fuels and to effectively use available renewable energy. REWatch is currently the only utility site that offers visibility to customer-sited distributed generation (DG-PV) information.

As the mainland regional transmission organizations (RTOs) or ISOs operate real-time and day-ahead markets, these organizations show the price of energy for their market, which may be misleading for Hawai‘i, given that we do not have a real-time market or corresponding balancing need. For RTOs and ISOs, customers are unaware of the system conditions that are dictating how the generating units are being run.



## **M. Component Plans**

### Generation Commitment and Economic Dispatch Review

The information displayed on our existing Renewable Watch website is a good starting point for creating visibility and transparency, especially for distributed generation resources.

We continue to work with industry partners (including Stem and Blue Planet) to share real-time system load and generation by percent of power for different resource types like wind, solar and DG resources. We support efforts to share information with customers so they can see their energy use and changes in generating resources from fossil to more renewables on the grid.

## N. Integrating DG-PV on Our Circuits

This appendix, through modeling analysis, identifies the anticipated problems on the distribution, sub-transmission, and transmission systems to integrate distributed and grid-scale PV. Various solutions are proposed and considered to address integration impacts, with a discussion about how these investments will remedy interconnection problems. This appendix also discusses the methodology and assumptions used to identify the problems and solutions.

### Overview

The PSIP plans presented in this December 2016 update utilize the high DG-PV forecast to meet our customer's energy needs. The high DG-PV forecast assumes that all single-family home customers and certain commercial sectors will meet their total energy needs through the installation of a PV system (see Appendix J: Modeling Assumptions Data). In sum, the forecast states that nearly 3,000 MW of DG-PV will energize our distribution systems across our companies.

With a renewed focus on customer-centric planning that will enable an advanced grid that customers can plug into, innovative planning and technologies are key components to transforming distribution systems that currently serve 1,500 MW of load, roughly half of the expected amount of DG-PV in 2045.

The transmission and distribution systems must now transition to an integrated grid; we can no longer operate and plan them as separate entities, as both ends of the electric power system will supply power. The integrated grid will enable DER to provide the services that are lost with the deactivation on traditional centralized conventional generation. With the paradigm shift to an integrated system, impacts are no longer

## N. Integrating DG-PV on Our Circuits

Grid Modernization Maximizes a Diverse Set of Resources

contained to the distribution system; the sub-transmission and transmission system need to transform to accommodate our customer’s desires.

We focused on identifying the problems we see today and the ones we anticipate in the near-term at all levels of the power system with respect to PV integration:

- Voltage power quality
- Conductor and equipment thermal overloads
- Operational flexibility
- Ground fault overvoltage

To solve these problems, we consider various solutions and strategies leveraging traditional solutions, emerging technologies, and advanced inverter capabilities. The ultimate solution in each case will depend on its benefits, cost, implementation time, and operability.

We developed integration costs for two DG-PV cases: the market DG-PV forecast and the high DG-PV forecast based on the April 2016 PSIP Update. Simulations of our sub-transmission and distribution system models informed the PV integration cost estimates.

Some of the solutions offered include:

Issue	Traditional (Wires)	Technology (Non-Wires)
Thermal Capacity	<ul style="list-style-type: none"> <li>■ Overhead and Underground Conductor Upgrades</li> <li>■ Distribution Transformer Upgrade</li> </ul>	<ul style="list-style-type: none"> <li>■ Energy Storage</li> </ul>
Voltage Power Quality	<ul style="list-style-type: none"> <li>■ Voltage Regulator Installation</li> <li>■ Distribution Transformer and Secondary Conductor Upgrades</li> </ul>	<ul style="list-style-type: none"> <li>■ Var Compensation Devices</li> <li>■ Advanced Inverters</li> </ul>
Operational Flexibility	<ul style="list-style-type: none"> <li>■ Circuit Re-Configuration</li> <li>■ New Circuit and/or Substation Transformer</li> </ul>	<ul style="list-style-type: none"> <li>■ Energy Storage</li> <li>■ Advanced Inverter DER Controllability</li> </ul>
Ground Fault Overvoltage	<ul style="list-style-type: none"> <li>■ Grounding Transformers</li> </ul>	<ul style="list-style-type: none"> <li>■ Fast Tripping Advanced Inverters</li> </ul>

Table N-1. Summary of Mitigation Solutions Considered

Utilizing our hosting capacity models and methodology, we analyzed high DG-PV scenarios to determine the near-term costs to integrate the forecasted PV. As policies are implemented to better align load with DER resources, the scope and magnitude of the circuit upgrades will change. Based on current circuit conditions, Table N-2 provides the costs to integrate the near-term high DG-PV forecast under different solution strategies.

Island Grid	Strategy 4: Traditional	Strategy 5: Traditional w/ Advanced Inverter Control	Strategy 6: Technology (Storage)	Strategy 7: Least Storage w/ Advanced Inverter Control	Forecasted PV
O'ahu	\$102M	\$145M	\$212M	\$92M	572 MW
Maui	\$70M	\$64M	\$179M	\$58M	126 MW
Hawai'i Island	\$22M	\$22M	\$39M	\$24M	113 MW

Table N-2. Near-Term Cost Comparison, High DG-PV Strategies, 2016-2020

In the near-term, traditional upgrades (Strategy 4) and advanced inverter control (Strategy 7) proved to be the most cost-effective options.

The Hawaiian Electric power system includes a sub-transmission system that often serves as the point of interconnection for grid-scale projects because of the geographic area that it covers on O'ahu. We conducted a preliminary hosting capacity analysis of the sub-transmission system and found one instance of overloaded conductors in the Wahiawa area, which modeled the April 2016 market DG-PV forecast and the grid-scale resources slated for installation through 2019.

A range of remaining sub-transmission capacity was then determined in the regions of high potential solar development as identified by NREL (See Appendix F: NREL Reports). Figure N-1 illustrates the sub-transmission constraints in these regions.

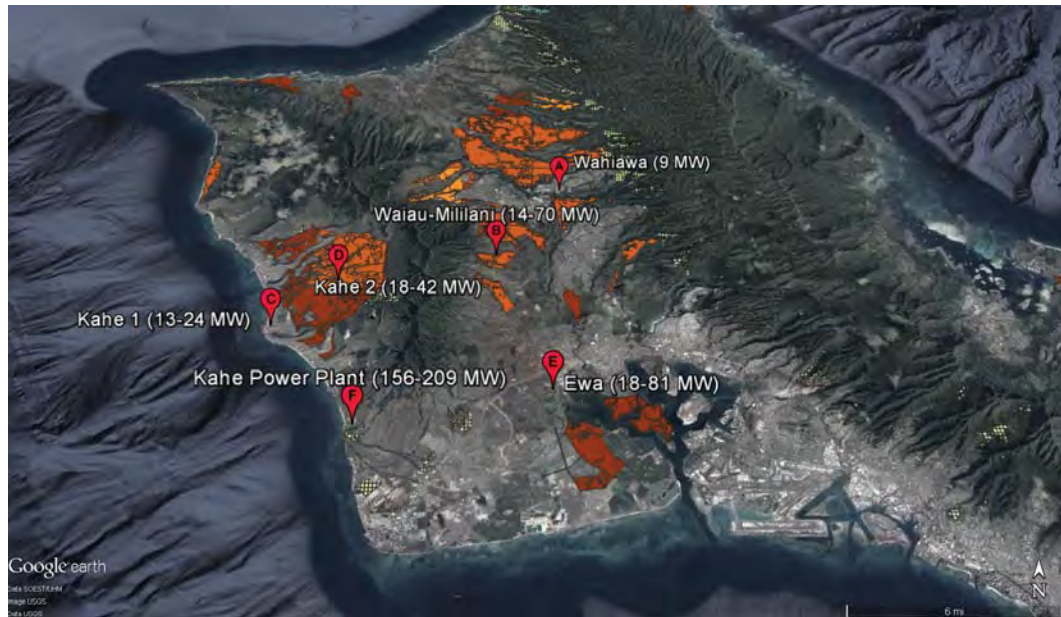

Figure N-1. Near-Term Sub-Transmission Capacity for Grid-Scale Resources by Solar Region

Once the sub-transmission system reaches capacity, we must weigh future transmission expansion against non-transmission alternatives to determine the best path forward to

## N. Integrating DG-PV on Our Circuits

### Grid Modernization Maximizes a Diverse Set of Resources

integrate the grid-scale and high DG-PV capacities in the mid- and long-term as laid out in these resource plans.

The technical analyses and cost implications are based on the DG-PV forecasts and grid-scale potential data available today. However, upon development of DER programs and policies and receipt of grid-scale proposals, we can better predict the market and location of resources, which in turn leads to a more accurate evaluation of the scope and cost of grid upgrades.

Customers will drive significant growth in DER. We will need to rely on innovative modeling techniques and tools to inform policymakers of the requirements for safe and reliable interconnection of customer resources. In order to achieve our goals, we will make significant investments in the grid to remedy the impacts seen today, and the impacts predicted by the transmission and distribution models for the future.

---

## GRID MODERNIZATION MAXIMIZES A DIVERSE SET OF RESOURCES

Hawai‘i’s grid modernization statute, enacted in 2013, directs the commission to “*consider the value of improving electrical generation, transmission, and distribution systems and infrastructure within the State through the use of advanced grid modernization technology in order to improve the overall reliability and operational efficiency of the Hawai‘i electric system.*”<sup>1</sup>

Consistent with the statute, we will identify grid modernization investments that, (1) maximize cost-effective interconnection of distributed energy resources and grid-scale resources, (2) maintain and enhance grid operating reliability and safety, (3) seek improved efficiencies in grid operations and interoperability, and (4) create an integrated grid through advanced planning, forecasting and operations.

We will modernize the grid through foundational technologies, an expanding range of energy innovations, traditional solutions, and new grid services. Foundational technologies such as advanced metering, a demand response management system, and an advanced distribution management system will replace exiting grid management tools built for one-way power flow. New management systems provide operators visibility into resources on the distribution system beyond the substation fence, to make better operational decisions. In combination with grid investments such as conductor upgrades, these technology platforms will facilitate two-way power flow.

Table N-3 summarizes our grid modernization efforts currently underway through various pending dockets, on our roadmap, or as discussed in this PSIP update.

---

<sup>1</sup> Hawai‘i Revised Statute §269-145.5.

## N. Integrating DG-PV on Our Circuits

Grid Modernization Maximizes a Diverse Set of Resources

Grid Modernization Investments		
Element	Description	Benefits/Grid Modernization Value
Grid Modernization Efforts that Indirectly Enable the PSIP Resource Plans		
Advanced Metering Infrastructure (AMI)	More than an automated meter reading device. Metering infrastructure that informs customers and utilities in real-time, a customer's energy consumption and power quality (for example, voltage).	<ul style="list-style-type: none"> <li>■ Provide customers access to energy use and information.</li> <li>■ Enables time-of-use and real-time pricing programs.</li> <li>■ Provides system operators and planners needed visibility to grid operations and power quality at DER point of interconnection.</li> <li>■ Enables two-way communication and control of smart home appliances and devices.</li> </ul>
Distributed Energy Resource Management System (DERMS)/Demand Response Managements System (DRMS)	A single integrated platform to manage DR and DER resources. This will allow information exchange, management, and dispatch of resources.	<ul style="list-style-type: none"> <li>■ Facilitate integration and management of DR and DER and their associated grid services otherwise provided by the utility.</li> <li>■ Improved grid operations and flexibility through aggregation services, load and curtailment forecasting, among others.</li> </ul>
Advanced Distribution Management System (ADMS)	An operational software platform that manages smart field devices, enhances outage management and operational capabilities, and provides operators additional grid insight.	<ul style="list-style-type: none"> <li>■ Improved efficiencies in outage planning and operations through better analytics of the grid enabled by DA/Substation automation.</li> </ul>
Distribution Automation (DA)/Substation Automation	Modernization of substations through telemetry and advanced protective relaying. Distribution automation with installation of remote fault current indicators, Intelligent switches, and sectionalizing devices.	<ul style="list-style-type: none"> <li>■ Increased situational awareness through substation telemetry.</li> <li>■ Improved grid reliability and resiliency (outage response) will maximize DER production and reliability.</li> </ul>
Modern Communications Network	A network architecture that combines wireless networks and fiber optics equipped with the bandwidth to support the transmission of system SCADA data, intelligent field device control, DER command and control, AMI real-time data and smart home device control, among others.	<ul style="list-style-type: none"> <li>■ The platform in which various communication mediums (3rd party aggregator, wireless field area network, lease line fiber) combine to support two-way communication and the interoperability of the advanced grid and its assets.</li> </ul>
Interconnection Improvement Program (IIP)	Online web portal to manage the application process to DER programs for customers.	<ul style="list-style-type: none"> <li>■ Facilitates an efficient interconnection process for customers and integrated grid forecasting and planning for the utility.</li> </ul>
Advanced Planning and Forecasting Tools	Enhanced forecasting and DER profiles through data analytics for advanced modeling and operations.	<ul style="list-style-type: none"> <li>■ The visibility AMI, ADMS, and DERMS will provide improved forecasting and modeling accuracy.</li> <li>■ Advanced and innovative modeling tools and techniques will be needed to transition to an integrated grid where significant generation and grid services are provided from the T&amp;D systems.</li> </ul>

## N. Integrating DG-PV on Our Circuits

Grid Modernization Maximizes a Diverse Set of Resources

Grid Modernization Investments		
Element	Description	Benefits/Grid Modernization Value
Grid Modernization Efforts that Directly Enable the PSIP Resource Plans		
Volt-var Optimization (VVO)	A technique to manage distribution voltages and reduce energy consumption while mitigating high voltages caused by PV. Devices such as static var compensation devices enable this.	<ul style="list-style-type: none"> <li>Enables integrated voltage control on the distribution system, which will increase hosting capacity and reduce inefficiencies.</li> <li>AMI and visibility of DER are key components that enable VVO.</li> </ul>
Advanced Inverters	Power electronic devices that enable distributed resources to provide grid support services.	<ul style="list-style-type: none"> <li>Resources such as PV and energy storage can provide grid services for the bulk system and distribution system to maximize DER deployment.</li> <li>Communication network and DERMS are critical to managing and configuring the inverters for optimal operation and dispatch.</li> </ul>
Synchronous Condensers	A synchronous machine that does not produce active power but instead reactive power.	<ul style="list-style-type: none"> <li>Will stabilize the grid by replacing inertia, fault current, and reactive power support that conventional generation previously provided.</li> </ul>
Contingency Energy Storage	Energy storage that can provide grid services such as fast frequency response and primary frequency response.	<ul style="list-style-type: none"> <li>With the deactivation of conventional generation and the increase variability of solar and wind, fast frequency responding resources will be needed for operating reliability and stability.</li> </ul>
Load Shifting Energy Storage	Cost-effective deployment of energy storage that can provide the grid generating capacity and regulation.	<ul style="list-style-type: none"> <li>Directly enables DER and grid-scale integration by shifting energy to when the grid needs it most while adding value with the stacking of regulating reserve services.</li> </ul>
Conductor Upgrades	Targeted deployment of conductor upgrades to the distribution system that increase capacity for DER integration. With high penetrations of PV on the distribution system, these upgrades will re-configure the traditional radial system (large wire sizes at the beginning of a circuit, smaller wires at the end).	<ul style="list-style-type: none"> <li>AMI, DERMS, DER and communications network will smartly manage energy and partially offset traditional grid upgrades. However, selectively targeting “heavy” grid upgrades will maximize DER production and minimize energy losses and inefficiencies.</li> </ul>
Transmission System Expansion	Provide grid-scale resources access to the transmission system through the expansion of the existing transmission substations at Kahe and Wahiawa, new transmission substations in the Lualualei and Helemano areas, and new transmission lines at N-I-I reliability will allow the grid to maximize the solar and wind potentials on the west and north sides of O’ahu.	<ul style="list-style-type: none"> <li>To accommodate the significant solar and wind potentials, as studied by NREL, on O’ahu, we will need additional capacity to deliver power to the east side of the island, and provide operators the flexibility to re-direct power flows.</li> </ul>

Table N-3. Grid Modernization Investments

Together these initiatives will enable the integrated grid that utilizes resources from the transmission system to a customer’s rooftop. We continue to prioritize smart energy management of renewable resources as a means to reduce grid investments; however, platforms such as AMI, DERMS, and ADMS will further enable higher DER penetration. For example, advanced meters provide the visibility planners need to realize efficiency

improvements in the interconnection process. Once interconnected, the modern communications network coupled with the DERMS and ADMS will allow the operator to better manage the power flows on the distribution system and avoid a substation upgrade. Distribution automation and an ADMS will result in quicker outage restoration times, which will maximize the availability of customer resources that are now depended on to meet the grid's total energy needs. Maintaining the reliability of the distribution system, which will contain over 2,000 MW of PV, is critical to the stability of the power system.

These complementary set of grid modernization efforts play a significant role in moving Hawai'i to 100% renewable energy.

---

## OUR VISION TO CREATE A GRID PLATFORM FOR ALL CUSTOMERS

We believe our expertise as the grid operator for the past 125 years puts us in a unique position to enable the grid platform needed to maximize the adoption and utilization of advanced DER technologies. Customers have come to expect from us: safe and reliable service, standby electric service, timely restoration following a weather event, and a high standard of power quality. The complexities of the grid have not stopped us from delivering those services.

We seek to improve on those services customers are accustomed to, while developing the platform that enables us to be the primary grid integrator. Creating an ecosystem of DER technologies that facilitates efficient energy transactions will benefit all customers as we make investments to modernize the grid.

We will accomplish this with the use of rapidly advancing technologies to manage the grid – advanced energy management, a smart grid, and a communications network that supports the interoperability of an assorted mix of distributed assets.

We envision customers seamlessly making energy choices that serve their own energy needs while benefiting the overall grid. Customers can choose to charge their EV where they work or live; place PV on their rooftop or invest in a community project; invest in storage that aligns with the system needs; allow system operator control of non-critical loads.

### New Concepts to Provide Operating Reliability

Operating reliability (or system security), is the ability of the electric system to withstand sudden disturbances such as electric short circuit faults or unanticipated loss of system components. We will integrate large quantities of variable wind and



## N. Integrating DG-PV on Our Circuits

Our Vision to Create a Grid Platform for All Customers

solar into our island grids, displacing traditional conventional central station generation. Although DER, to a certain extent, can reduce losses and loading constraints, the de-committing of conventional generation offsets those benefits because the system loses voltage control, short circuit availability, inertia, and primary frequency response services. Conventional generators provided multiple grid services that secured the grid; replacing these services with multiple assets will require innovative planning and operations.

Frequency support is required to stabilize frequency on the synchronized grid and to maintain continuous load and resource balancing by deploying automatic response functions in response to frequency deviations. Under pre- and post-contingency conditions, system operators must have the ability to raise or lower generation or load, automatically or manually. Alternatively, we can carefully deploy autonomously responding resources, not under the visibility and control of the utility, to maintain the balance of the grid, while not compromising system security.

Voltage support and short circuit availability is required to maintain system level voltages on the grid within established limits, under pre- and post-contingency situations; thus, preventing voltage collapse, system instability, or delayed fault clearing. The increased voltage support and short circuit current will strengthen the grid making it better able to withstand disturbances.

Some of the Companies' technical strategies for operating reliability are outlined in Table N-4.

Issue	Current Methods	Future Methods
Frequency Support:	<ul style="list-style-type: none"> <li>■ Inertia is the stored rotating energy in a power system provided by online synchronous and induction generation operating at least their minimum power output level.</li> <li>■ Primary frequency response (droop) is the automatic corrective response of the system, typically provided by synchronous generation, to react or respond to a change in system frequency.</li> <li>■ Spinning reserve is typically provided by synchronous generation that is ready to ramp up or down in response to a frequency deviation.</li> <li>■ Demand response is the reduction of load to balance loss of generation triggered at a predetermined frequency set point and limited by program participants.</li> <li>■ Under frequency load shed scheme is the automatic disconnection of blocks of load to re-balance the system during a frequency disturbance.</li> </ul>	<ul style="list-style-type: none"> <li>■ Synchronous condensers and flywheels to provide inertia.</li> <li>■ Fast frequency response resources such as batteries, flywheels, curtailed PV and wind energy that can respond in cycles, upwards, by injecting energy into the grid.</li> <li>■ Demand Response resources (with fast frequency response characteristics) that can respond within a specified time adequate to correct frequency imbalances. This can be reductions in load or injection of real power from DER aggregated into a controllable and quantifiable program to respond to under frequency events, or a fast injection of controllable load in response to an overfrequency event.</li> <li>■ Autonomous downward response of inverter based DER resources configured with the advanced inverter frequency-watt function to respond to an overfrequency event.</li> </ul>

Issue	Current Methods	Future Methods
Voltage Support/Short Circuit Availability	<ul style="list-style-type: none"> <li>Reactive power supply and voltage control provided by synchronous generating facilities, excitation systems, and capacitors.</li> <li>Protective relay schemes designed to isolate faults within cycles.</li> <li>Fault current supplied by synchronous generators.</li> <li>Dynamic reactive power capability of synchronous generators and static var compensators.</li> </ul>	<ul style="list-style-type: none"> <li>Synchronous condensers to provide reactive power support and short circuit current. Repurposing deactivated generators as condensers.</li> <li>Storage systems such as battery storage, electric vehicles, flywheels, and thermal storage to provide quick and flexible energy sources to stabilize system balancing.</li> </ul>

Table N-4. Strategies for Maintaining Operating Reliability

### New Distribution System Supports Customer Choice and DER Connection

We envision an advanced distribution system where customers can plug their distributed resources into the grid. The grid will provide the overall operating safety net for all customers and supervision of DER so that power quality and reliability meets their needs. An expanding portfolio of new energy technologies and services will support the grid while it continues to provide efficient electric service.

The diverse set of resources – battery storage, electric vehicles, thermal storage, and PV – located on the low voltage system will require advanced planning solutions to predict and resolve their impacts. We will adopt old and new best-fit solutions to grid constraints. Table N-5 describes some of the solutions to resolving capacity, voltage power quality, and operational flexibility issues.

Issue	Traditional (Wires)	Technology (Non-Wires)
Thermal Capacity	<ul style="list-style-type: none"> <li>Overhead and underground conductor upgrade to relieve capacity overloads from excess load or generation. This can also mitigate high and low voltage.</li> <li>Distribution transformer upgrade to relieve equipment overloads during peak load or generation periods.</li> </ul>	<ul style="list-style-type: none"> <li>Energy Storage can play the role of energy shifting by relieving daytime congestion caused by PV to shave the evening peak should a distribution system have a peak capacity issue.</li> </ul>
Voltage Power Quality	<ul style="list-style-type: none"> <li>Voltage regulator installation can control voltage by adjusting to changes in load and generation. Installation of line regulators in weaker circuit areas can mitigate the effects of rising voltages during PV production.</li> <li>Distribution transformer and secondary conductor upgrades can alleviate voltage rise on the secondary level that occur during light load and high PV periods. Performing this upgrade reduces the impedance between the inverter and the distribution transformer.</li> </ul>	<ul style="list-style-type: none"> <li>Var compensation devices are devices that act faster than traditional voltage regulators and can provide reactive power capabilities to positively influence feeder voltage.</li> <li>Advanced inverters can provide reactive power control to positively influence voltage.</li> </ul>

## N. Integrating DG-PV on Our Circuits

Distribution System Overview and the Planning Process

Issue	Traditional (Wires)	Technology (Non-Wires)
Operational Flexibility	<ul style="list-style-type: none"> <li>■ Circuit re-configuration can help to rebalance loads and generation between circuits to maintain the N-I planning criteria and operational flexibility.</li> <li>■ New circuit and/or substation transformer when generation backfeeds at the substation violates the N-I planning criteria then new substation capacity must be built to maintain the distribution system's integrity and flexibility. This is similar to serving a distribution system's peak load.</li> </ul>	<ul style="list-style-type: none"> <li>■ Energy Storage can limit the amount of energy exported at the substation by storing energy in excess of the N-I planning criteria.</li> <li>■ Advanced inverter DER controllability will allow system operators to manage the resources during abnormal conditions. For example, grid-scale projects have controls that allow system operator to control its active power output when safety and reliability are at risk.</li> </ul>

Table N-5. Strategies for Resolving Distribution-Level Impacts

## DISTRIBUTION SYSTEM OVERVIEW AND THE PLANNING PROCESS

The distribution system is the part of the electric power system that distributes or disperses power from the transmission system to individual customers. To deliver electricity to spatially diverse customers, engineers must strike the appropriate balance between reliability and power quality in order to design an economically viable distribution system.

The term “one-way power flow” often describes the traditional method of power system design. One example of one-way power flow refers to the architecture of the distribution system. Our distribution systems are predominantly designed as a radial system; that is, starting at the substation the distribution circuit is designed to handle greater capacity (or bigger wires) and tapers outward (or designed with less capacity, smaller wires) as the system distributes power to customers farther away from the substation. In other words, the capacity of the distribution circuit closest to the substation is the greatest, as it must have the throughput to push power to all customers on a circuit. As one moves towards the end of a circuit (farther away from the substation), there are less customers left to serve; therefore, less capacity or throughput is required. As customers add solar to their rooftops deeper into the distribution system, the smaller wires at the end of the circuit may lack the capacity to accommodate excess energy that flows back towards the substation.

One major component of the distribution system (Figure N-2) is the distribution substation; this is the point in the electric power system where the transmission or sub-transmission system delivers power at high voltages and converts the power to medium voltage for distribution of power at safer and more economical means. Our distribution systems consist of 2,400-volt, 4,160-volt, 11,500-volt, 12,470-volt, and 24,940-volt systems; these voltages are also known as the primary part or primary voltage of the

distribution system. The substation transformer generally supplies power to two circuits (or feeders) that serve as the means to deliver power to customers – circuits are identifiable as poles and wires at the side of a road. Higher voltage distribution circuits have more capacity than lower voltage distribution systems. The lower voltage distribution systems – 2,400 volt and 4,160 volt – are at higher risk for power quality and capacity issues. Often times, these issues are resolved by converting these circuits to a higher voltage, such as 12,470 volts.

The final major component of the distribution system is the distribution transformer, sometimes referred to as the service transformer. This piece of equipment converts the medium voltage, 2,400 through 24,940 volts, to a lower voltage, 120/240 volts for final delivery to customers. The majority of appliances and devices used by consumers operate at 120 or 240 volts. Residential customers normally share a distribution transformer, and receive power via wires that branch out from the transformer to each individual home. Larger customers who have bigger load requirements often have a dedicated transformer and service connection.

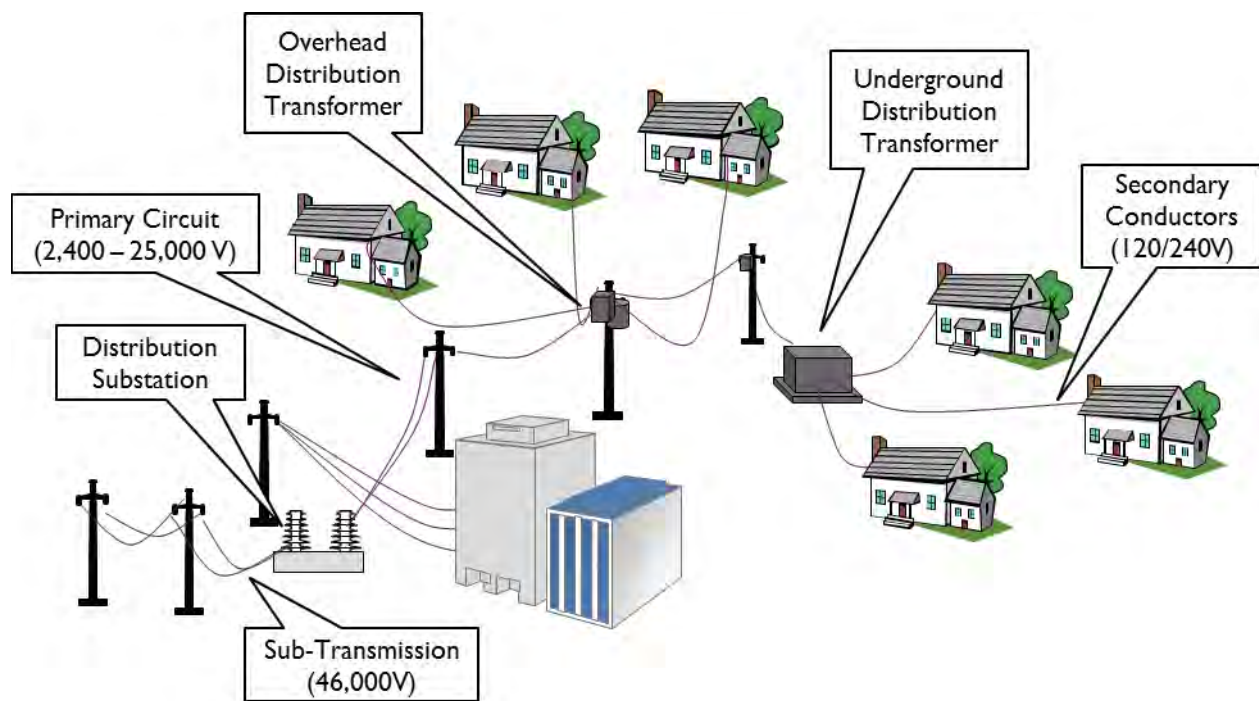

Figure N-2. Major Components of the Distribution System (Illustration)

To ensure the reliability of electric service to all customers, radially fed circuits have ties to adjacent circuits. The tying of circuits within the distribution system provides system operators the flexibility to reconfigure the distribution system to restore power during a contingency event – planned or unplanned outage. Distribution planners also reconfigure circuits to maintain reliability and power quality for customers; for example, significant load growth may create power quality or capacity issues, in which case, a

## N. Integrating DG-PV on Our Circuits

Distribution System Overview and the Planning Process

portion of a circuit permanently transfers to another circuit to avoid overloading equipment or degrading power quality.

Figure N-3 illustrates the operational flexibility concept. Should a substation be taken out-of-service, planned or unplanned, a neighboring substation can restore power by closing a switch that ties the two circuits together, but normally open during normal operations.

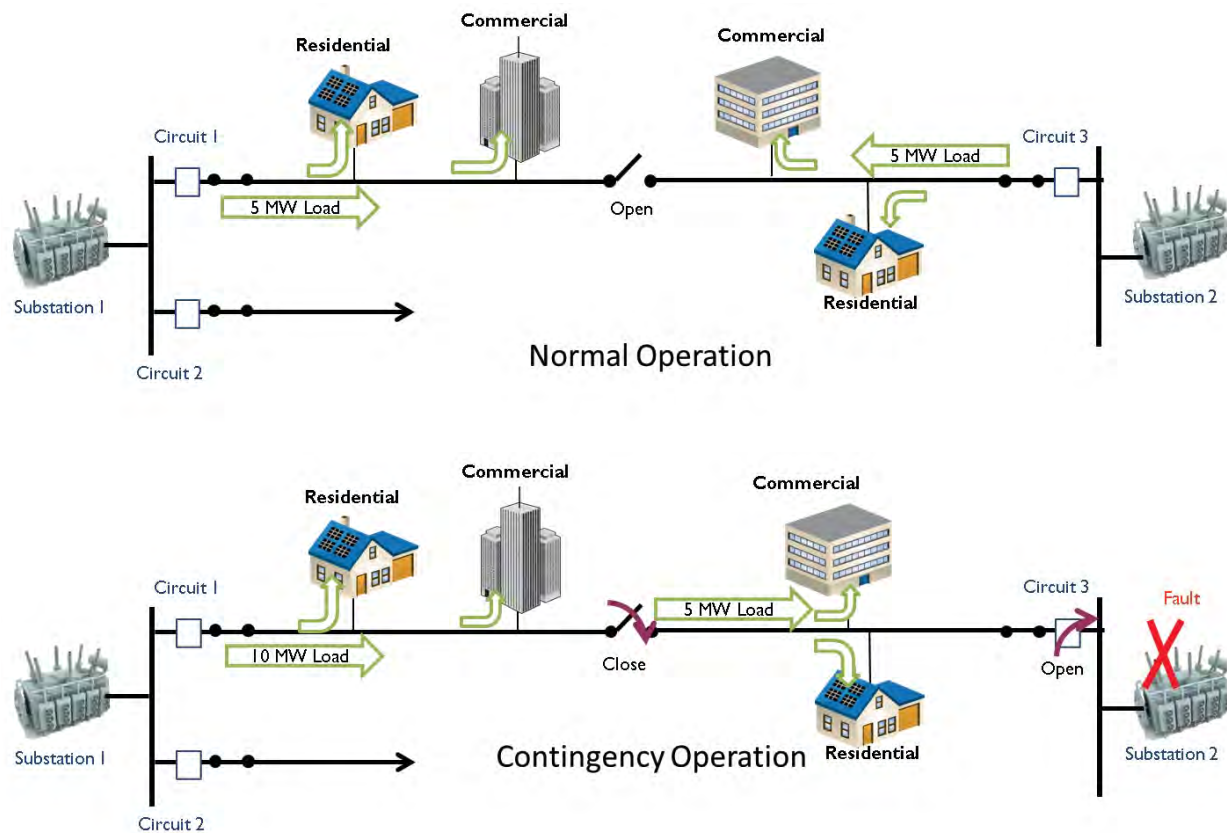

Figure N-3. Operational Flexibility (Illustration)

Maintaining this operational flexibility is critical to our ability to provide continuous electric service.

### Distribution Planning

On an annual basis, Distribution Planning conducts Substation Load and Capacity Analysis (SLACA) of the distribution system. This entails analysis of the previous year's substation transformer loading data – from our SCADA system, if available – to examine whether the highest peak load observed at the substation transformer violates distribution planning criteria. That is, a substation transformer shall have the capacity to not only accommodate the highest peak demand and any forecasted load growth, but also accommodate the load from the loss of a neighboring substation transformer (N-1

reliability) based upon the greater of the transformer loss-of-life rating, protective fuse rating, or cooling rating. Simply put, these ratings are the thermal limit of the transformer. Failure to meet this criterion may result in accelerated equipment failure.

There are normally multiple ties between circuits that provide system operators the ability to expediently restore power without risk of damaging equipment. To understand this concept, we can apply a rough rule of thumb; at peak load conditions, transformers are loaded to 50% of its rated capacity. In other words, a reserve margin of 50% of the transformer capacity is maintained during normal circuit configurations or operations to provide the operational flexibility of the system. This 50% reserve margin is then used to accommodate the load (or reverse power from PV) of a neighboring out-of-service substation transformer during an outage event.

It is common for the configuration of the distribution system to change from year to year; this also affects PV hosting capacities. The following factors drive the dynamic nature of the distribution system: changing customer behavior, load growth, load imbalances, or degradation of power quality.

Upon completion of the SLACA analysis, Distribution Planners address any planning criteria (including loss of operational flexibility) violations. Planners first seek the most efficient, least cost strategy; for example, permanently reconfiguring a circuit by transferring load from a substation that exceeds the 50% capacity threshold to a neighboring substation that is loaded less than 50% can cost-effectively restore operational flexibility. If least cost solutions fail to resolve the planning criteria violations, Planners seek longer lead, more costly solutions; for example, the construction of a new substation to create capacity. Planners determine load growth by new customer service requests, economic or land development projections, and load trends. Unlike mainland utilities, the SLACA analysis is not completed seasonally. Hawai'i does not see significant load variations between winter and summer months, nor do we benefit from increased capability of utility equipment due to cooler ambient temperatures.

Distribution Planning also performs similar capacity analysis on the sub-transmission system, utilizing a similar process to resolve capacity issues.

### **Distributed Energy Resource Planning**

Distributed Energy Resource (DER) planning and the exponential PV growth experienced within the last couple of years have evolved the traditional distribution planning process. We recently employed a process and methodology to perform hosting capacity analysis to more appropriately predict and plan for the integration of DG-PV. As shown in Figure N-4, almost 50% of the distribution circuits have more PV than the daytime minimum load; reverse flow is commonplace on Hawai'i grids. This is not the case for other systems throughout the United States.

## N. Integrating DG-PV on Our Circuits

Distribution System Overview and the Planning Process

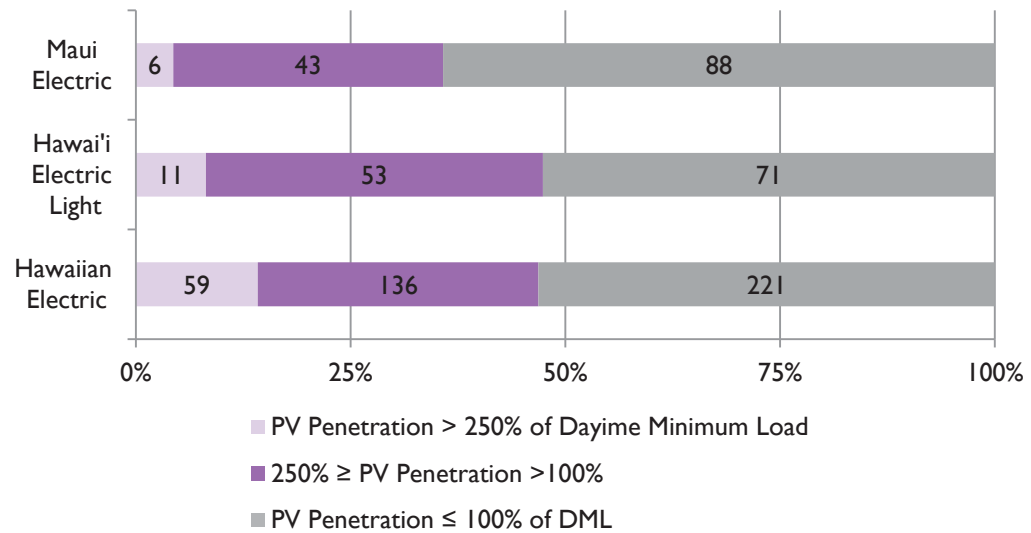

Figure N-4. Circuit PV Penetration by Daytime Minimum Load

Based on previous high DG-PV penetration studies we have conducted, coupled with field experience, the hosting capacity analysis evaluates (1) voltage power quality, (2) equipment and wire capacity, and (3) operational flexibility. Undoubtedly, there are many more potential impacts that can affect the safety, reliability, and power quality of electric service to all of our customers, but these three issues are of the utmost immediate near-term concerns. As part of the hosting capacity analysis, an Operational Circuit Limit is also determined. This limit defines the reverse power threshold at the substation to maintain the operational flexibility of the circuit—the same principle described as part of the Distribution Planning process above.

A PV system's impact to a distribution system is highly dependent on its actual location with consideration of a number of factors: load, circuit impedance, neighboring PV systems. The hosting capacity analysis, through software simulation and analytics, determines the amount of PV a circuit can accommodate, regardless of location, before violating one of the three criteria discussed above. The interconnection of PV above that hosting capacity may incur capital improvements to mitigate any expected impacts. More details regarding the hosting capacity analysis are in the document titled, *Rooftop PV Interconnections: A Methodology of Determining PV Circuit Hosting Capacity* filed in Docket No. 2014-0192, on December 11, 2015.

As earlier discussed, Planners plan the distribution system based on the peak demand of a circuit. However, with the introduction of PV, distribution system planning must now account for minimum load, high generation periods in addition to the traditional evening peak period.

Under the net energy metering program, it was common practice for customers to size PV systems to offset their annual energy usage; the unintended technical consequence of this practice results in energy exports greater than the customer’s typical peak load, which the distribution system was originally designed to accommodate. Consequently, during solar peak hours and daytime load levels, the peak export of energy onto the distribution system is greater in magnitude and more coincident than a customer’s evening peak load. This increased power flow during minimum load periods will create power quality and capacity impacts that must be addressed before integrating high amounts of PV. Figure N-5 illustrates this point; a customer with the average 6 kW PV system will zero-out his or her annual energy usage. This equates to an average monthly consumption of 806 kWh (531 kWh per weekdays per month). On a typical residential load profile, this energy usage equates to a peak demand of 2.3 kW. During daytime minimum loads, when this customer is not home, the PV exports up to 4.5 kW. During daytime hours, the load flow on the secondary part of the system is 4.5 kW, as opposed to its previous peak loading of 2.3 kW in the evening; nearly double the normal peak loading. This amount of exported energy exceeds any design margins of the distribution system.

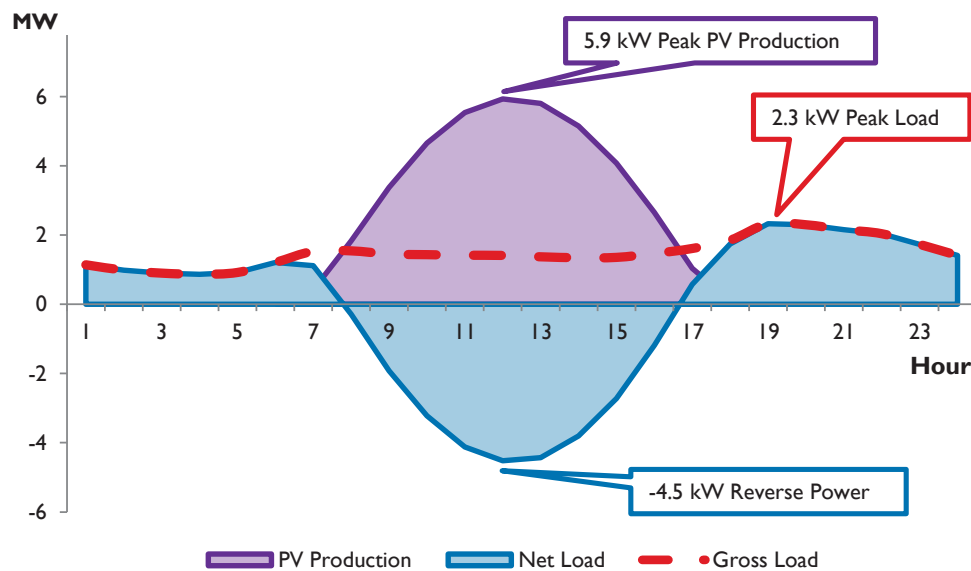

Figure N-5. Typical Weekday Residential Customer Load Profile

The lack of PV production diversity as compared to the load diversity seen during the evening peak load creates PV integration challenges on the distribution system. Load diversity and the non-coincident behavior of customers allow distribution planners to plan the distribution system under peak demand conditions with certainty that customers will not simultaneously consume power at their peak; the distribution system is designed to accommodate diversified customer load – not the maximum potential



## N. Integrating DG-PV on Our Circuits

### Distributed PV Interconnection Impacts

load. For instance, a service transformer serving 10 homes typically has a diversity factor<sup>2</sup> as much as 45%. In contrast, PV systems lack the same type of diversity as all PV production is a function of the sun's irradiance and not a function of diverse human behavior. Diversity from the placement, angle, and direction of a PV system equates to roughly 75%–85% of the maximum capacity, not nearly the same overall reduction as load diversity. Put another way, the sun does not shine when customers are consuming the most electricity.

By necessity, the hosting capacity analysis will develop into a more dynamic and granular analysis, as battery, electric vehicle, and the deployment of other distributed resources continue to grow. Battery standards that recognize a battery's unique characteristic of functioning as a load and generator will be established to create grid positive benefits; charging when the system most needs load, discharging when it most needs generation—in steady-state and transient conditions.

As the State continues to electrify transportation, electric vehicle charging should coincide with system needs as to not impress undue strain on utility equipment and operations. The dynamic hosting capacity models should integrate these behind the meter distributed energy resources to efficiently, design, plan, and operate the distribution grid.

---

## DISTRIBUTED PV INTERCONNECTION IMPACTS

With an added emphasis on customer-sited distributed resources, and an expectation that by 2045, customers would supply over 2,400 MW of PV and nearly an equivalent amount of grid-scale resources, the impacts are no longer contained to the distribution system. Other components of the power system will require evaluation and proactive mitigation to ensure continued safe and reliable service for our customers.

### Distribution System Impacts

This iteration of the PSIP includes a forecast that significantly increases distributed rooftop PV. It is anticipated that the following impacts will continue to grow:

- Voltage power quality/regulation (high and low voltage)
- Conductor and equipment thermal overloads
- Operational flexibility (operational circuit limit)

---

<sup>2</sup> Diversity factor is the ratio of actual coincident peak load to the sum of all customers' non-coincident peak load. For example, the total non-coincident peak load for 10 homes may be 100kW, but at any given time the total loads that must be served by the utility 4.5kW. In other words, not all homes are running its water heater, oven, and other appliances at the same time.

Future analysis and continued power quality monitoring of the distribution system will ensure other PV impacts such as flicker, imbalance, protection, among others, do not occur<sup>3</sup>. The three impacts listed above represent the near-term concerns based upon model simulations and field data.

As discussed in *Rooftop PV interconnections: A Methodology of Determining PV Circuit Hosting Capacity* filed in Docket No. 2014-0192 on December 11, 2015, our analysis of the Companies’ distribution system concluded that continued PV growth will require solutions to mitigate voltage power quality, conductor and equipment overloads, and operational flexibility deficiencies. For example, we have recorded high voltage conditions caused by PV. Figure N-6 illustrates one real-world example where PV caused voltage to rise during daytime hours:

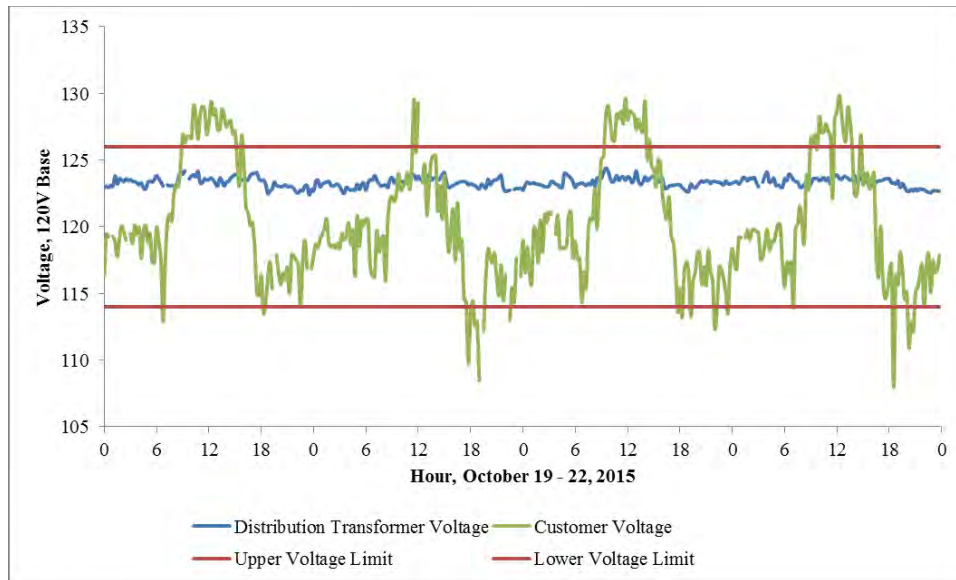

Figure N-6. Customer Meter Voltage Readings and the Serving Distribution Transformer

Figure N-6 presents actual data captured at the distribution transformer and the customer’s meter. This particular customer installed a 10 kW PV system which clearly caused voltage to rise during the peak solar hours (that is, noon), as compared to the voltage seen at the distribution transformer (monitoring point). The approximate 6–7 volt rise seen between the monitoring point (blue line) and the customer (green line) caused the customer’s PV to violate the prescribed voltage limits of national standards and Hawaiian Electric power quality rules. To resolve this issue, Hawaiian Electric executed a \$14,000 project to install an additional (new) distribution transformer closer to this customer’s house to reduce the distance between the distribution transformer and the

<sup>3</sup> High-Penetration PV integration Handbook for Distribution Engineers Seguin, Woyak, et. al. NREL/TP-5D00-63114. January 2016.

## N. Integrating DG-PV on Our Circuits

### Distributed PV Interconnection Impacts

customer's house; thereby, reducing the voltage rise to within acceptable standards (depicted in Figure N-7).

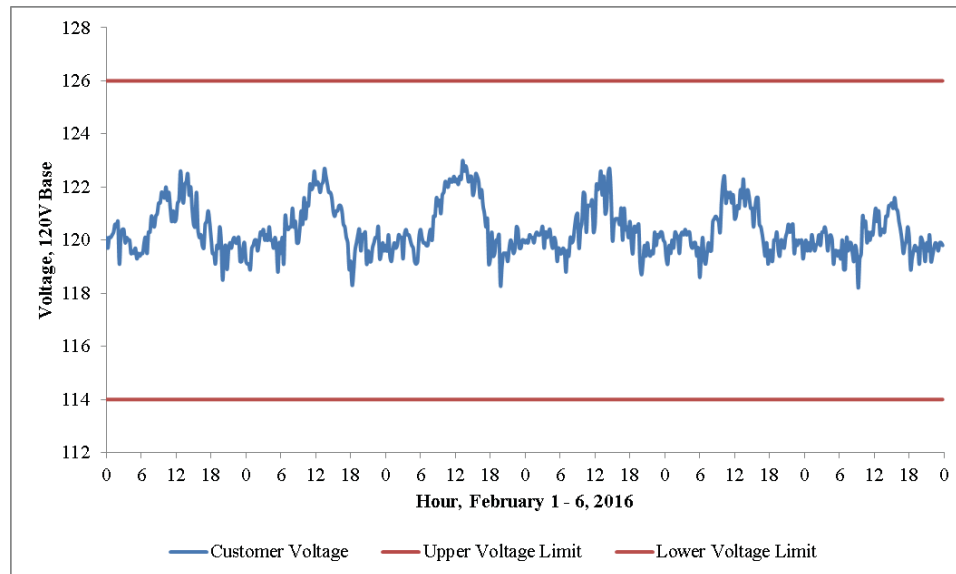

Figure N-7. Customer Meter Voltage Readings After Secondary Overvoltage Mitigation Installed

Although Figure N-6 shows that low voltage occurrences are infrequent, the high voltage “humps” during the middle of the day have expanded the total voltage range (from peak to trough of the green line) between 8 and 10 volts. This is significant because it eliminates “headroom” or reserve margins we previously retained to ensure voltage stays within the prescribed limits. Before having PV on the distribution system, we utilized the voltage headroom to prevent low voltage by shifting the voltage band upwards. The high voltage conditions caused by PV have cut into the margins we previously maintained.

### Sub-Transmission PV Impacts

Hawaiian Electric’s power system, unlike the Maui Electric and Hawai‘i Electric Light grids, includes a true sub-transmission system, which transmits electricity from the bulk generation and transmission system to the distribution system.

The Hawaiian Electric grid contains a radially fed 46,000-volt sub-transmission system. In a radial configuration, customers experience a momentary outage during a sub-transmission fault while the primary source switches to the back-up source (Figure N-8). During these disturbances, DG-PV and sub-transmission connected generation will electrically trip offline, similar to a transmission line fault. The Hawaiian Electric sub-transmission and transmission system experienced 219 momentary or sustained interruptions in 2015. These interruptions directly affect the reliability of grid-scale and residential rooftop PV connected to the sub-transmission and distribution systems.

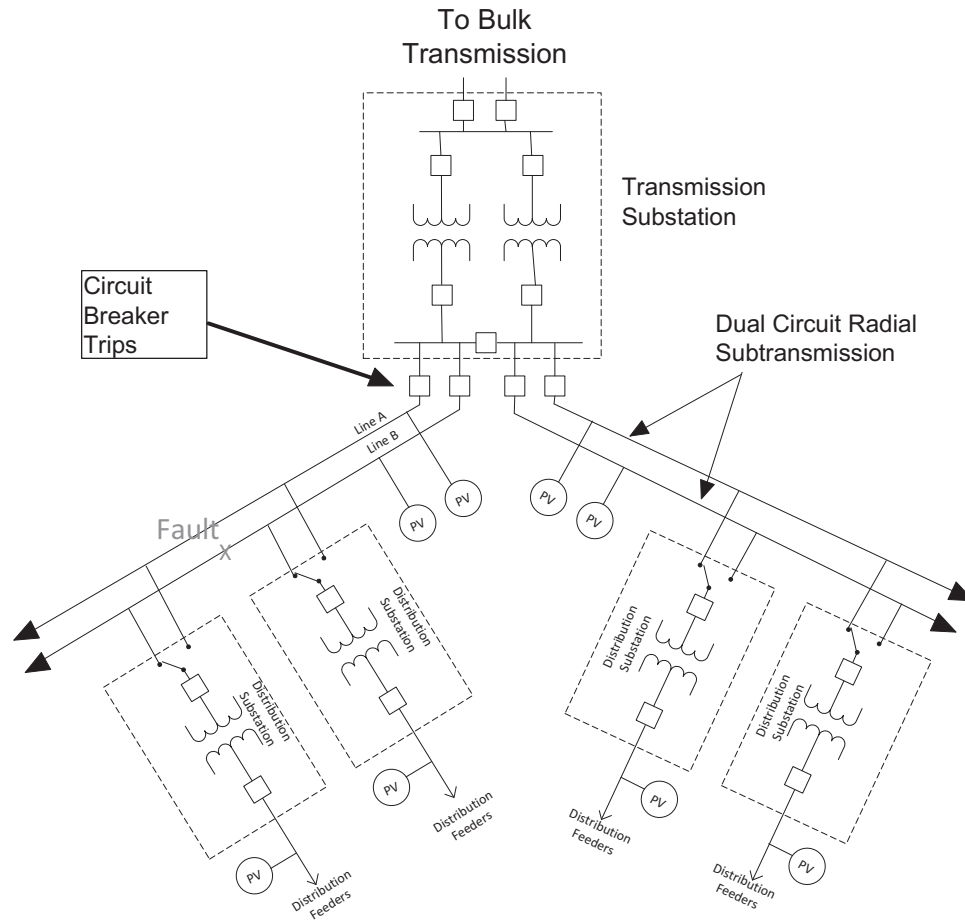

Figure N-8. Illustration of a Radial Sub-Transmission System

Similar to the distribution system, and based on past interconnection requirements studies for grid-scale projects, and a recently completed preliminary sub-transmission hosting capacity analysis, the following are anticipated impacts to the sub-transmission system:

- Conductor and equipment overloads
- Operational flexibility
- Ground fault overvoltage
- Voltage power quality / regulation

The preliminary analysis, which included the April 2016 market DG-PV forecast for 2045, and past studies indicate that conductor capacity is the primary limitation to interconnection. The maximum capacity on a single sub-transmission line is 55 MVA, the largest overhead conductor size at 46,000 volts.

Operational flexibility is less of a concern with grid-scale resources than distribution connected projects because system operators have direct control of projects greater than

## N. Integrating DG-PV on Our Circuits

### Distributed PV Interconnection Impacts

250 kW at Maui Electric and Hawai'i Electric Light, and 1 MW at Hawaiian Electric. This allows operators to adjust a PV plant's output during emergencies, abnormal, or contingency situations.

Recent interconnection studies have determined that ground fault overvoltage will require mitigation. The recent studies analyzed six different sub-transmission lines for ground fault overvoltage. Of the six lines, four of the circuits had a penetration of at least 120% of daytime minimum load; all four demonstrated a violation of the ground fault overvoltage threshold, which is determined by the withstand rating of our lightning arrestors.

Ground fault overvoltage can occur from a sub-transmission fault where the feed-in of fault current from the PV systems on the distribution system create a neutral-shift, ground fault overvoltage. Failure to address ground fault overvoltage would result in damage to utility lightning arrestors, and any sub-transmission loads connected single-phase to ground.

We conducted an inverter ground fault overvoltage study with the National Renewable Energy Laboratory<sup>4</sup> to study the inverter behavior during single line to ground faults. While the tests were positive for distribution-level faults (wye-ground: wye-ground transformer configurations), testing of sub-transmission faults (delta-wye-ground transformer configurations) was inconclusive as to whether inverters will cause damaging ground fault overvoltage.

### Transmission System PV Impacts

The transmission system is the optimal interconnection point for large generation because of the increased capacity and reliability relative to the distribution and sub-transmission system. The transmission system on O'ahu at 138,000 volts can carry significantly more capacity than the sub-transmission system (430 MVA versus 55 MVA). Additionally, Hawaiian Electric designs the transmission system for N-1-1 reliability and at Maui Electric and Hawai'i Electric Light, N-1 reliability. Hawaiian Electric designs its sub-transmission system for N-1 reliability. The expected transmission issues discussed here relate to the physical interconnection of grid-scale resources. Appendix O: System Security Analysis includes a more comprehensive analysis of the transmission system impacts, specifically, system security constraints.

### *Wahiawa Transmission Constraint*

Two transmission lines serve the Wahiawa Substation on O'ahu. Historically, when one of the lines is out of service for maintenance and the remaining line unexpectedly trips

---

<sup>4</sup> Hoke, Nelson, et al (August 2015). *Inverter Ground Fault Overvoltage Testing*. Golden, Colorado: National Renewable Energy Laboratory, TP-5D00-64173.

out of service due to a fault, the substation becomes de-energized, thereby resulting in the loss of approximately 40 MW to 130 MW of load depending on the time of day. This N-1-1 contingency is part of the Hawaiian Electric Criteria for Transmission Planning.

With the proliferation of grid-scale and distributed renewable generation throughout the distribution system, equipment failure contingencies, which previously resulted only in the loss-of-load, could potentially result in a loss of large aggregate generation that may result in system instability.

There is currently up to 98 MW of wind generation that flows through the Wahiawa Substation. An additional 50 MW firm generation plant (Schofield Generating Station) plans to connect to Wahiawa Substation in the near future. The total generating capacity from the existing wind generation and Schofield Generating Station connected to the Wahiawa Substation will be approximately 148 MW. Assuming a minimum loading of 42 MW at the Wahiawa Substation, the maximum net generation supplied from Wahiawa Substation to the grid can reach 106 MW.

The current largest loss of generation contingency for O'ahu is AES at 200 MW, which has resulted in three blocks of load shed in actual recent AES outage events. In order to limit the size of the largest loss of generation contingency to 200 MW in the future, the amount of additional generation capacity at the Wahiawa Substation should be limited to 94 MW.

### *Kahe Constraint*

At the Kahe 138,000-volt switching station, power delivery to the east side of the island is constrained by the N-1-1 planning criteria. Based on PSSE power flow analysis, the worst N-1-1 contingency occurs when the Kahe-Waiiau and Kalaeloa-Ewa Nui transmission lines are out of service, and the CEIP-Ewa Nui transmission line overloads (Figure N-9).

## N. Integrating DG-PV on Our Circuits

### Distributed PV Interconnection Impacts

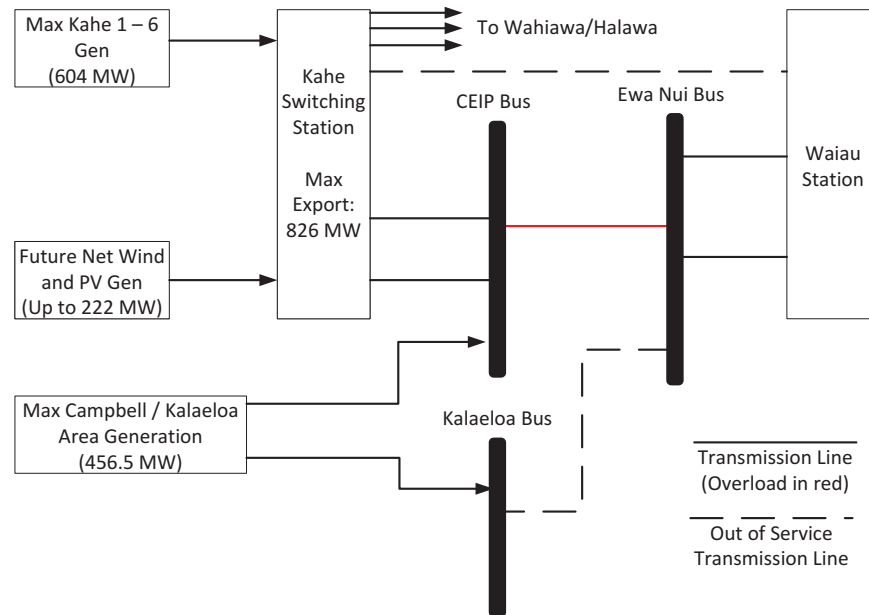

Figure N-9. Power Export Limit to the Eastern Part of the Island of O'ahu

The maximum export from Kahe switching station to serve loads east of Kahe is 826MW. This assumes 900MW of generation at the Kahe Power Plant and 74MW load at Kahe switching station.

The six Kahe generating units account for a maximum generation of 604 MW; there is room for an additional 222 MW of generation that can interconnect to the sub-transmission lines at the Kahe switching station bus.

New generation projects on the west side of O'ahu could potentially face capacity constraints until generating units at Kahe or AES are retired.

As more generation (including battery energy storage) is shifted to the west and north side of O'ahu (as the Waiau generating units are deactivated and the load center remains east of Ewa), load flow studies will continue to be required to ensure there is sufficient transmission capacity to export power to serve the urban load center.

### *Ancillary Services*

High DG-PV scenarios on the distribution system may preclude distributed resources from providing certain ancillary services because distribution equipment will operate at, or near capacity. For example, if a transformer is at capacity to accommodate PV production during the day and the system needs fast frequency response, there is no additional capacity to accommodate the injection of power from this frequency service. However, reserving capacity or scheduling active power production as part of a demand response program will create the necessary capacity to provide those services.

---

## DISTRIBUTION INTEGRATION METHODOLOGY, SOLUTIONS, AND COSTS

The development of integration plans and costs for the two DG-PV forecasts followed a five-step process.

1. Allocate PV forecasts to the distribution circuits.
2. Model the impact of forecasted PV on the distribution system.
3. Identify solution options to integrate the forecasted PV.
4. Quantify the integration plans and costs for all solutions.
5. Derive integration cost estimates.

We describe each step in the methodology below.

### Step 1: Allocate PV Forecasts to the Distribution Circuits

The DG-PV forecasts reflect the system-wide forecasted growth of DG-PV on each island grid for the two DG-PV scenarios. To determine the cost to integrate these total DG-PV levels, we analyzed the impact to each individual circuit. The installation of DG-PV is a customer choice; thus, we cannot predict the exact installation location of future DG-PV at the circuit level. This analysis assumed PV would grow proportional to current circuit penetration levels, with the rationale that the PV industry has identified and penetrated those market segments, neighborhoods and circuits with the resources and market drivers to adopt PV.

We increased each circuit's existing PV level year over year by the growth rate determined by the PSIP April 2016 market and high DG-PV forecasts. PV grew on each circuit constrained by its maximum potential, which was determined by estimating the number of single-family homes residing on each circuit. A customer's historical 12-month energy consumption dictated the size of future PV systems. The maximum potential also considered the commercial sector by estimating that 25% of commercial customers on a circuit installed PV. Where Hawai'i Electric Light and Maui Electric did not have detailed demographic data of a circuit, customer counts and rate class information were used as a proxy to estimate the maximum PV potential of the circuit.

A circuit did not receive additional growth after the year in which it reached its maximum PV potential. Circuits that currently have low penetration did not reach its maximum potential, as it is indicative of neighborhoods with sub-optimal solar conditions or neighborhoods with low market drivers. Many currently saturated circuits reached their maximum potential well before 2045.



## N. Integrating DG-PV on Our Circuits

Distribution Integration Methodology, Solutions, and Costs

Figure N-10 through Figure N-12 compare the updated forecast with the forecast used for the integration costs as determined for the April 2016 PSIP update.

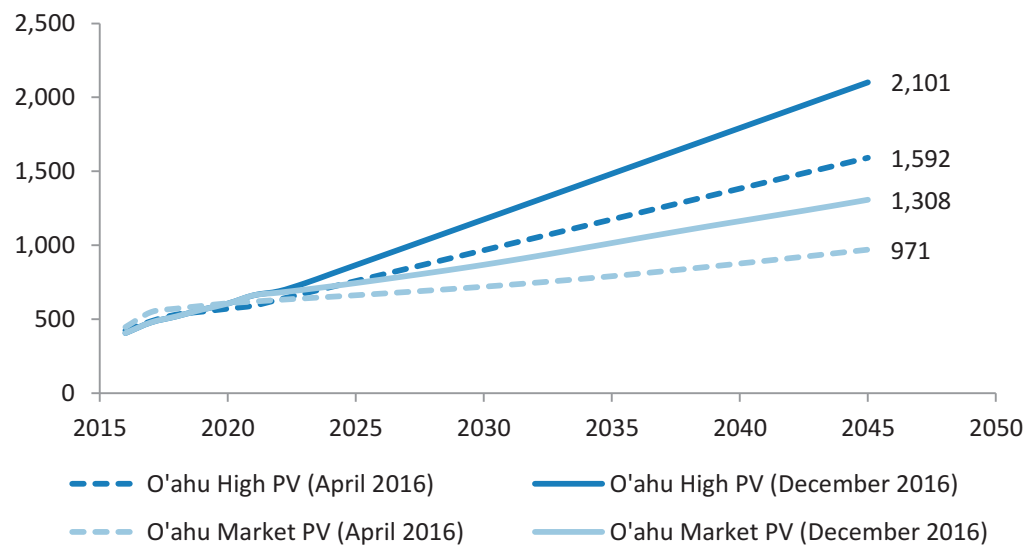

Figure N-10. O'ahu Market and High DG-PV Forecast

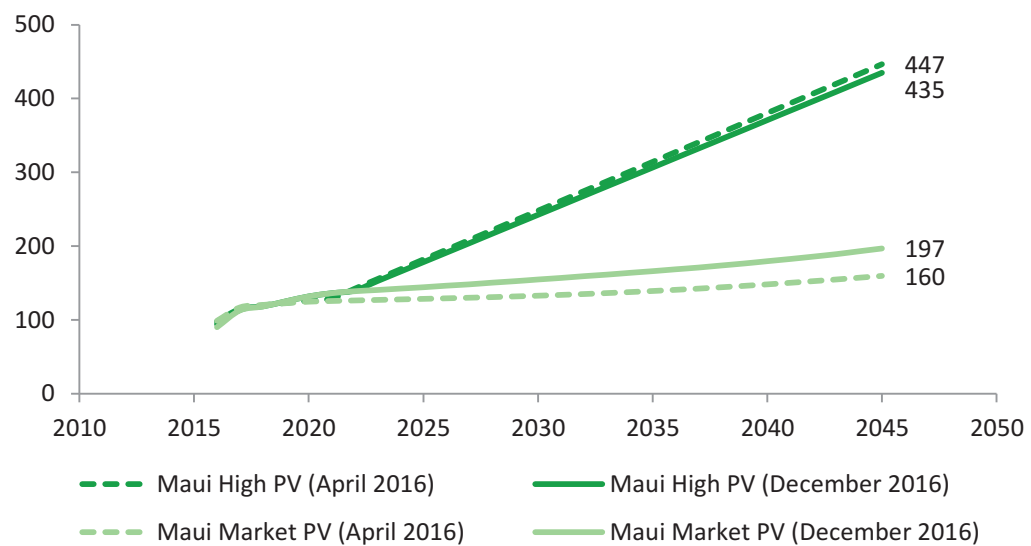

Figure N-11. Maui Market and High DG-PV Forecast

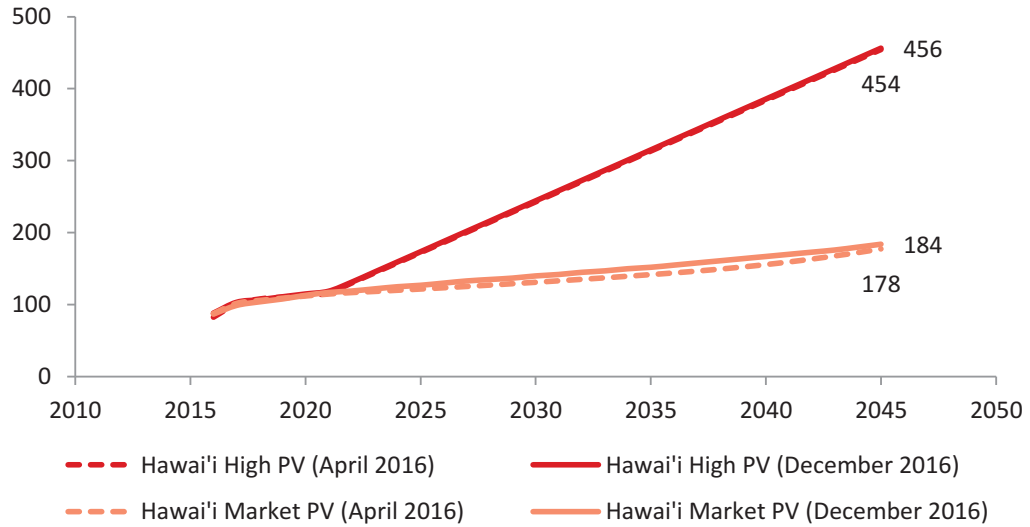

Figure N-12. Hawai'i Island Market and High DG-PV Forecast

The December 2016 forecasts compared to April 2016 shows a marginal difference in the Hawai'i Island and Maui high DG-PV forecast. The Maui market forecast increased by 23%. However, the O'ahu forecasts increased by 32% and 35% in the high DG-PV and market DG-PV forecast, respectively. In all cases, the 5-year forecast remains relatively unchanged.

The revised forecasts also provide a storage component as part of the customer self-supply program. We expect the additional storage component to help offset any additional PV impacts resulting from the increased revised PV forecasts. For these reasons, the DG-PV integration costs discussed here remain unchanged over the April 2016 update as it serves as a reasonable proxy.

The section "DG-PV Forecasts by Distribution Circuit" (page N-63) details the DG-PV adoption by circuit.

## Step 2: Model the Impact of Forecasted PV on the Distribution System

Any circuit forecasted to exceed its hosting capacity or operational circuit limit<sup>5</sup> was analyzed to determine the cost to integrate the forecasted PV amount. Circuits not forecasted to exceed its hosting capacity did not incur major circuit upgrades; therefore, an integration cost was not determined. Table N-6 and Table N-7 tabulate the number of circuits, for each operating company, that are forecasted to exceed their hosting capacity and operational circuit limit in the market DG-PV case and high DG-PV case.

<sup>5</sup> The hosting capacity is the level of PV that a circuit may host without requiring upgrades to the primary part of the distribution system. The operational circuit limit defines the reverse power threshold at the substation to maintain the operational flexibility of the circuit.

## N. Integrating DG-PV on Our Circuits

Distribution Integration Methodology, Solutions, and Costs

Market DG PV Case	Total Distribution Circuits	Exceeded Hosting Capacity Only	Exceeded Operational Circuit Limit
Hawaiian Electric	416	64	86
Maui Electric	137	44	7
Hawai'i Electric Light	135	49	22

Table N-6. Circuits Forecasted to Exceed Hosting Capacity and Operational Circuit Limit (Market DG-PV)

High DG-PV Case	Total Distribution Circuits	Exceeded Hosting Capacity Only	Exceeded Operational Circuit Limit
Hawaiian Electric	416	41	160
Maui Electric	137	76	76
Hawai'i Electric Light	135	20	94

Table N-7. Circuits Forecasted to Exceed Hosting Capacity and Operational Circuit Limit (High DG-PV)

The analysis assessed three areas in determining integration costs: thermal capacity, voltage power quality, and operational flexibility. The analysis used the hosting capacity models<sup>6</sup> to grow each circuit to its forecasted PV amount. We flagged any conductor that exceeded 100% of its thermal rating from the reverse power flow of PV for mitigation.

Analyzing voltage power quality requires a deeper analysis of the hosting capacity models, and analysis results vary by location. Mitigation of unacceptable voltage levels normally requires multiple iterations of load flow simulations. Consequently, we analyzed a cross section of representative circuits with their forecasted PV growth amounts, and applied the results to all distribution circuits. We flagged areas where PV caused voltage to rise more than 2.5% of nominal on the primary for mitigation. ANSI Standard C84.1, Range A, requires delivery of voltage to customers at  $\pm 5\%$  of nominal voltage. Our typical design of the distribution system allows for 2.5% voltage drop or rise between the substation and the distribution transformer (primary side) and 2.5% voltage drop or rise between the distribution transformer and the customer meter, totaling to the delivery of voltage within  $\pm 5\%$  of nominal voltage.

Maintaining the flexibility of the distribution system is vital to the reliability and safety of electrical service to our customers. If the forecasted reverse power flow from PV of a circuit exceeds that circuit's operational circuit limit then that circuit was flagged for mitigation.

<sup>6</sup> See *Rooftop PV Interconnections: A Methodology of Determining PV Circuit Hosting Capacity* filed in Docket No. 2014-0192, on December 11, 2015.

### Step 3: Identify Solution Options to Integrate the Forecasted PV

The identification of solutions to resolve thermal capacity, voltage power quality, and operational flexibility issues are categorized as traditional “wires” solutions and technology “non-wires” solutions. While many different solutions exist, Table N-8 describes the various solution options considered in this analysis. The cost-effective option served as an input to DG-PV adoption model.

Solution Portfolio		
Issue	Traditional (Wires)	Technology (Non-Wires)
Thermal Capacity	<ul style="list-style-type: none"> <li>■ Overhead and Underground Conductor Upgrade</li> <li>■ Distribution Transformer Upgrade</li> </ul>	<ul style="list-style-type: none"> <li>■ Battery Energy Storage</li> </ul>
Voltage Quality	<ul style="list-style-type: none"> <li>■ Voltage Regulator Installation</li> <li>■ Distribution Transformer and Secondary Conductor Upgrades</li> </ul>	<ul style="list-style-type: none"> <li>■ Var Compensation Devices</li> <li>■ Advanced Inverters</li> </ul>
Operational Flexibility	<ul style="list-style-type: none"> <li>■ Reconfigure Circuit</li> <li>■ New Circuit and/or Substation Transformer</li> </ul>	<ul style="list-style-type: none"> <li>■ Battery Energy Storage</li> <li>■ Advanced Inverter DER Controllability</li> </ul>

Table N-8. Portfolio of Solutions to Integrate Forecasted DG-PV Amounts

It is important to draw a distinction between mitigation and optimization solutions. The analysis completed here are necessary upgrades. Failure to implement these solutions would compromise distribution system safety and reliability, including its effect on non-participating customers. Technology solutions in particular, will restore the integrity of the system to normal operating conditions and generally do not provide circuit optimization or improved efficiencies.

The following describe in detail each of the solutions in the portfolio.

**Overhead and Underground Conductor Upgrade.** Excess rooftop PV energy will create reverse power flow that may load conductors past 100% of their thermal rating. To create additional rated capacity, conductors are upgraded to a larger size. Load flow simulations of the hosting capacity models with PV grown to the forecasted PV amounts determined the total length of overloaded conductors in the market and high DG-PV cases. The total length of overloaded conductors by circuit were scheduled for upgrade between the year the PV forecast per circuit exceeded the hosting capacity and ending in the final year of PV growth. The cost to upgrade overhead conductors including wood pole construction is estimated at \$1,100,000 per mile in 2016 dollars. The cost to upgrade underground conductors including duct bank and manhole installation is estimated at \$4,300,000 per mile in 2016 dollars.

**Voltage Regulator Installation.** A voltage regulator is a traditional solution that corrects voltage power quality issues, and is installed on circuits that exceeded its hosting

## N. Integrating DG-PV on Our Circuits

Distribution Integration Methodology, Solutions, and Costs

capacity. High and low voltage will be the number one barrier to interconnection in the near-term.

Load flow simulations of representative circuits demonstrated that neighborhoods or sections of circuits might experience high and/or low voltage. Each circuit is unique and will vary in its voltage quality issues. Based on the representative analysis, we made the assumption that up to three voltage regulators per circuit would be required to correct voltage impacts. Each circuit that exceeded its PV hosting capacity incurred a voltage regulator installation for three consecutive years following the year in which it exceeded its hosting capacity, except in the case where PV growth stopped in less than three years. The cost to install a single-phase regulator and three-phase regulator is estimated at \$25,000 and \$75,000 respectively, and does not include potential wood pole replacement. For the purposes of this analysis, the unitized cost per voltage regulator installation was estimated at \$41,667 in 2016 dollars; the average cost of installing two single-phase regulators and one three-phase regulator.

**Distribution (Service or Secondary) Transformer Replacement.** Distribution transformers are upgraded, if the ratio of aggregate PV connected to a transformer to the transformer rating exceeds 200%.<sup>7</sup> In other cases, secondary high voltage will necessitate an upgrade of secondary conductors in addition to the replacement of the distribution transformer.<sup>8</sup> The load flow simulations of the hosting capacity models determined that in the market DG-PV case, 16% of distribution transformers would have a PV penetration (the ratio of aggregate PV connected to a single transformer to the transformer rating) in excess of 200%, and 26% in the high DG-PV case. We applied these results to predict the amount of future transformer upgrades required to resolve both loading and voltage issues, which can be mutually exclusive. The average cost for this upgrade is estimated at \$13,500, representing the estimated average cost between a transformer upgrade to address overloading and an upgrade to address secondary high voltage. In practice, correction of secondary high voltage may cost more than \$13,500, particularly if underground construction is required; however, for this analysis all service transformer work was assumed to cost \$13,500 in 2016 dollars.

**Reconfigure Circuits.** The most cost-effective method to resolve the loss of operational flexibility is to reconfigure a circuit. Before requiring any type of substation upgrades, planners will analyze the circuits to determine whether a circuit is capable of reconfiguration with an intertied circuit. We did not perform this analysis in the

---

<sup>7</sup> The Companies worked with their distribution transformer manufacturer to determine the appropriate PV penetration level as to not severely impact the life and performance of the transformer. Based upon the results of the manufacturer analysis, it was determined that we would allow 200% PV penetration on a distribution transformer before taking remedial action.

<sup>8</sup> Distribution transformer upgrades can be triggered well in advanced of a circuit reaching hosting capacity. Issues related to distribution transformer upgrades were not considered in establishing a circuit's hosting capacity. Whether a distribution transformer upgrade is required is dependent on a set of localized factors.

development of the integration costs except for a few cases; the vast majority of operational circuit limit exceedances were resolved with substation upgrades. As circuits approach these limits in future years, we will always seek to avoid substation upgrades where possible. No capital costs were assigned for this work.

**Substation Upgrades.** Substation upgrades are triggered in two ways: (1) if operational flexibility is lost where reverse power loads the substation transformer more than 50% of its highest transformer rating, or (2) with controllable PV, reverse power flow loads the substation transformer more than 100% of its highest transformer rating. Current operational practice maintains operational flexibility during normal operation, and therefore reverse power flow is roughly limited to 50% of the substation transformer's highest rating. However if PV is controllable through the use of advanced inverters, it is possible to allow reverse power flow to load the transformer up to 100% of its thermal rating during normal operation, and regulate the PV power output during abnormal conditions.

There are a number of factors to consider in determining the cost of a substation upgrade. The scope of the upgrade could include building a new substation on new land, installing a new substation transformer and circuit(s) in an existing substation, installing a new circuit at an existing substation transformer, or converting a 4kV substation to 12kV.<sup>9</sup> Broad assumptions were made for this analysis; in practice, detailed engineering will determine the scope of the upgrade.

The base assumption for a substation upgrade is \$10,000,000, which includes two (46kV) terminations, two substation transformers, two 12kV switchgears, four 12kV feeders, one acre of land, and communication infrastructure. We unitized the cost on a per feeder basis with considerations of various factors. For example, if a substation transformer exceeded the 50% limit, the two circuits it serves require a substation upgrade. If the existing substation has space for an additional substation transformer, land costs were subtracted from the base \$10,000,000 and divided by four feeders to arrive at the per feeder cost. In this example, the per feeder cost is \$2,000,000. The range of costs used for a substation upgrade varies between \$1,000,000 and \$5,000,000 per feeder in 2016 dollars. Each circuit was analyzed at a high level (without detailed engineering) to determine the most appropriate cost of the upgrade.

**Battery Energy Storage Systems.** Deploying distributed battery energy storage systems behind or in front of the meter can relieve distribution system congestion and maintain

---

<sup>9</sup> If 4kV substation transformers or circuits require an upgrade, we will convert that area to a higher primary voltage, instead of installing additional 4 kV substations. This is part of an overall strategy to convert 4kV areas to higher primary voltages. These costs were not included in the DGIP based upon the assumption that 4kV circuits would eventually be converted. However in this analysis these costs are included because the 4 kV conversion projects would not coincide with PV growth. This adds significant cost over what was reported in the DGIP. 4kV conversions are higher in cost than new substation installations (\$5M vs \$2M-\$3M on a per feeder basis) because of the labor hours required to retrofit a circuit with higher primary voltage wires and transformers.

## N. Integrating DG-PV on Our Circuits

Distribution Integration Methodology, Solutions, and Costs

operational flexibility. Strategically located storage can avoid conductor overloads, while simultaneously maintaining operational flexibility. Battery cost assumptions are provided in the resource cost forecast in Figure N-13.

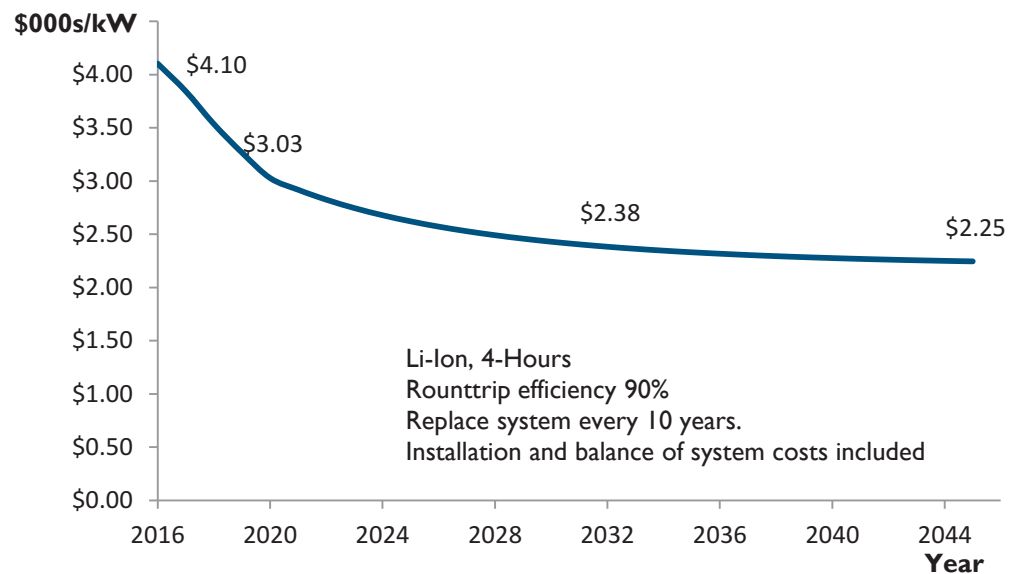

Figure N-13. BESS Cost Assumptions

Battery energy storage systems need to be accountable when deployed to relieve capacity and operational flexibility issues. One important design characteristic for this type of battery energy storage system is to ensure each morning the battery capacity is available to store that day's excess energy; otherwise, the excess energy will cause an overload. For this analysis, we assumed a four-hour charge and discharge cycle battery.

While battery energy storage systems may avoid the installation of a new substation, circuit or conductor upgrade, the current state of the technology estimate a 10-year lifecycle. Replacement storage quantities and costs were included in the integration cost estimates 10 years from the original deployment of a battery energy storage system. It should be noted that conductor upgrades and substation upgrades have lifecycles in excess of 20 years; therefore, not assumed to require replacement. In addition, battery energy storage system failure must be accounted for. Rather than building redundant storage, the cost effective option is a combination of energy storage and circuit-level control of advanced inverter powered DG-PV. If a battery fails and compromises the safety and reliability of the system, DER control mechanisms should activate to regulate the active power output, particular if multiple failures occur simultaneously.

**Var Compensation Devices.** Var compensation devices leverage modern power electronics to provide fast acting reactive power to reduce voltage fluctuations, and regulate circuit voltages to avoid the high voltage effects of deep penetrations of DG-PV. These devices come in many different forms: low voltage static compensators, fast

switching capacitors, inline power regulators, and advanced inverters. These types of devices, located on the secondary part of the distribution system, can potentially provide more cost-effective and efficient regulation to mitigate voltage quality impacts and displace traditional, slower acting equipment such as capacitor banks and voltage regulators. This distributed voltage regulation technique represents a departure from traditional industry methods of voltage regulation. While we have started to demonstrate and assess these innovative devices, the technology is a relatively recent development and has yet to achieve widespread adoption across the industry. We will determine the viability and deployment of these devices once we complete our assessment of these devices from a planning and operating perspective.

To quantify the cost of these devices, representative circuits were modeled to determine the quantity of existing inverters that are required to have reactive power capabilities to mitigate existing high voltages. It was determined that for O‘ahu and Maui 12% of the existing inverter fleet would require retrofit. However, a smart inverter retrofit is not the sole method to resolve high voltage issues given the implementation challenges with customer ownership of the PV inverters. Therefore, the analysis assumed a non-specific solution that includes all device strategies discussed above. An estimated cost to install power electronic devices that provide reactive power compensation was based on a unitized cost estimated at \$855 per kilowatt in 2016 dollars. This cost was derived from an NREL report discussing PV costs for residential, commercial and utility-scale systems<sup>10</sup> in Hawai‘i.

**Advanced Inverter DER Controls Infrastructure.** Distribution system management will require controllability of customer DER assets by the system operator to maintain safe, efficient, reliable operations. Advanced inverters will play a pivotal role to enable controllability, which we now require as part of our most recent revisions to interconnection Rule 14H. The cost to implement DER controls include foundational infrastructure such as: advanced distribution management system, a distributed energy resource management system (DERMS), advanced metering infrastructure (AMI); however, for the purposes of the integration cost estimates, only infrastructure required to directly implement controls on a DER asset are considered. Controllability costs are not incurred until 2018, at which time it is assumed that the DERMS and AMI projects are installed and capable of initiating basic controls of DER assets. The cost of the DERMS and AMI projects were not included in this study’s integration costs. It is assumed that every new DER system will be outfitted with the necessary hardware and software to enable controllability; this cost is estimated at \$1,500 per system. Assuming

---

<sup>10</sup> See Chung, Davidson, et al (September 2015): *U.S. Photovoltaic Prices and Cost Breakdowns: Q1 2015 Benchmarks for Residential Commercial and Utility-Scale Systems*, Golden, Colorado: National Renewable Energy Laboratory, TP-6A20-64746 at 7–9. This report states the cost to install a 5.2kW PV system in Hawai‘i is \$3,280 per kW in 2015\$. The \$855 per kW unitized cost was derived by subtracting the supply chain, balance of system, PV module and racking, customer acquisition, overheads, and profit costs from the \$3,280 estimate.



## N. Integrating DG-PV on Our Circuits

Distribution Integration Methodology, Solutions, and Costs

an average PV system size of 6 kW, the number of total PV systems installed each year was determined. This \$1,500 per DER system cost estimate is a high-level estimation of the cost of communication hardware (such as, communication gateway) and any associated firmware costs.

Communication standards are under development within the utility and solar industry.<sup>11</sup> We assumed for this study availability of these capabilities in 2018.

### Step 4: Quantify the Integration Plans and Costs for All Solutions

Upon completion of the circuit specific analysis, the portfolio of integration solutions were each quantified into various strategies. This section describes the different strategies (and associated costs) that we considered to integrate PV in the market and high DG-PV cases. The strategies fell into two general categories – traditional or wires solutions and technology or non-wire solutions – that were then used to create three DER integration strategies in the market case and four DER integration strategies in the high DG-PV case.

- Strategy 1: Traditional or wires solutions to integrate the market DG-PV case.
- Strategy 2: Technology or non-wires solutions to integrate the market DG-PV case.
- Strategy 3: No storage solution with advanced inverter controls to integrate the market DG-PV case.
- Strategy 4: Traditional or wires solutions to integrate the high DG-PV case.
- Strategy 5: Traditional or wires solutions with advanced inverter controls to integrate the high DG-PV case.
- Strategy 6: Technology or non-wires solutions to integrate the high DG-PV case.
- Strategy 7: Least storage solution with advanced inverter controls to integrate the high DG-PV case.

#### *Strategy 1 and 4: Traditional or Wires Solutions*

Traditional or wires solutions solve thermal equipment overloads, degraded voltage quality, or loss of operational flexibility by upgrading or installing conductors, transformers, or voltage regulators. In these two strategies, operational flexibility is maintained by creating a new substation and/or circuits when the reverse power flow from excess PV generation exceeds 50% of the transformer rating.

Traditional upgrades are proven, tested solutions with an asset life of 20+ years compared to less traditional solutions such as energy storage, which may require

---

<sup>11</sup> The California Smart Inverter Working Group recently filed DER communication recommendations with its Public Utilities Commission; a decision is still pending. Arizona Public Service and Tucson Electric Power are currently running rooftop solar programs testing smart inverter capabilities, including inverter communications, <http://www.solarelectricpower.org/utility-solar-blog/2015/january/arizonas-utility-owned-solar-programs-new-price-models,-grid-integration-and-collaboration.aspx>.

**N. Integrating DG-PV on Our Circuits**

Distribution Integration Methodology, Solutions, and Costs

replacement in 10 years. Depending on the scope, traditional solutions may have significantly longer installation times.

Figure N-14 through Figure N-19 summarize by island, the cost to integrate PV under Strategy 1: traditional solutions in the market DG-PV case, and Strategy 4: traditional solutions in the high DG-PV case.

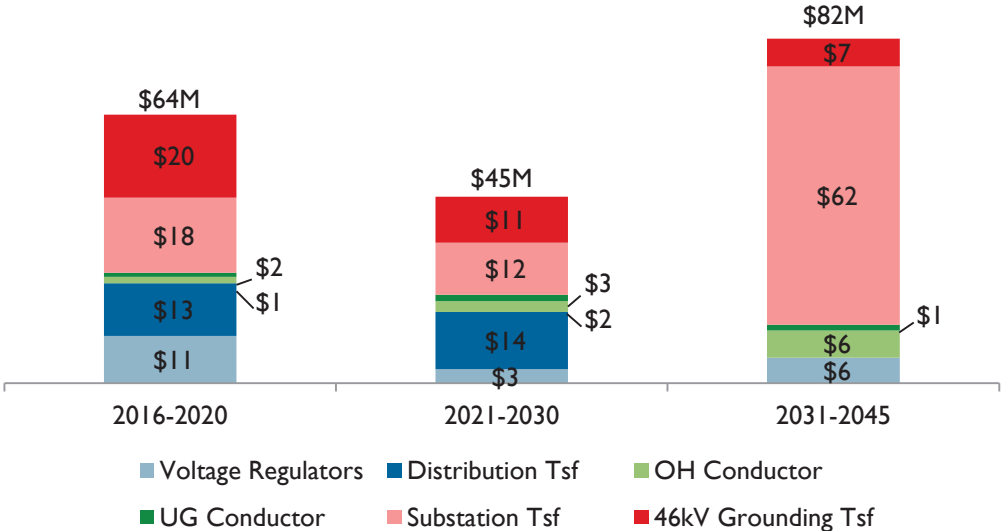

Figure N-14. Strategy I Annualized Integration Costs: O'ahu (Nominal \$M)

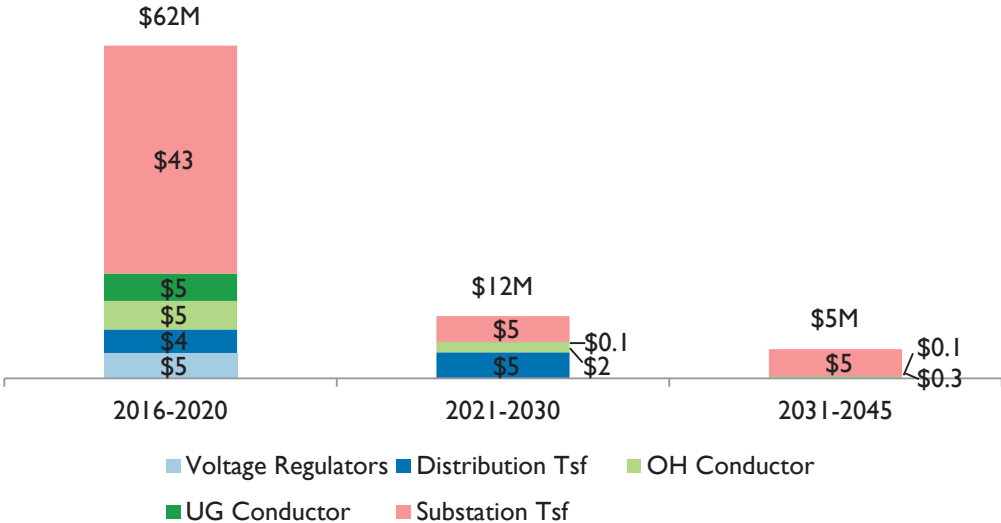

Figure N-15. Strategy I Annualized Integration Costs: Maui (Nominal \$M)

## N. Integrating DG-PV on Our Circuits

Distribution Integration Methodology, Solutions, and Costs

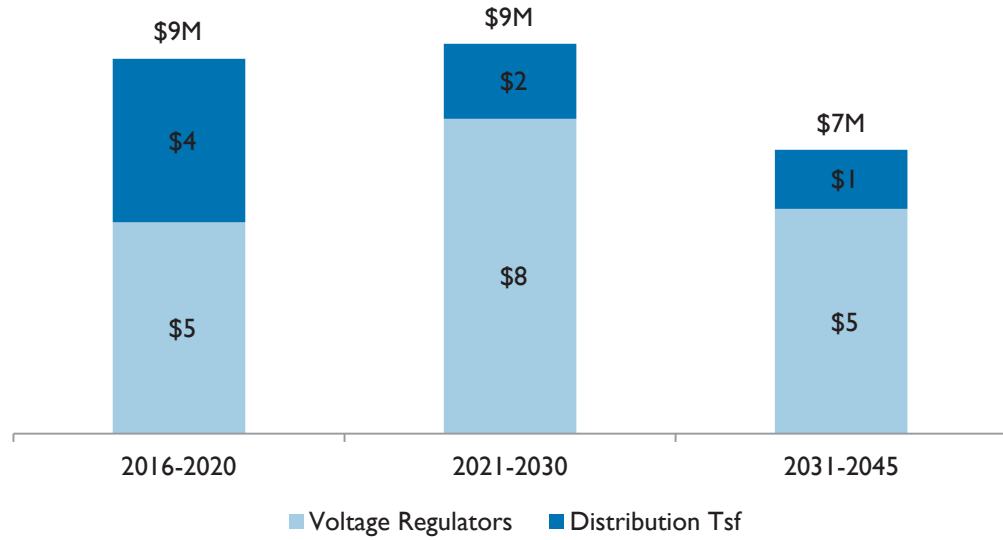

Figure N-16. Strategy I Annualized Integration Costs: Hawai'i Island (Nominal \$M)

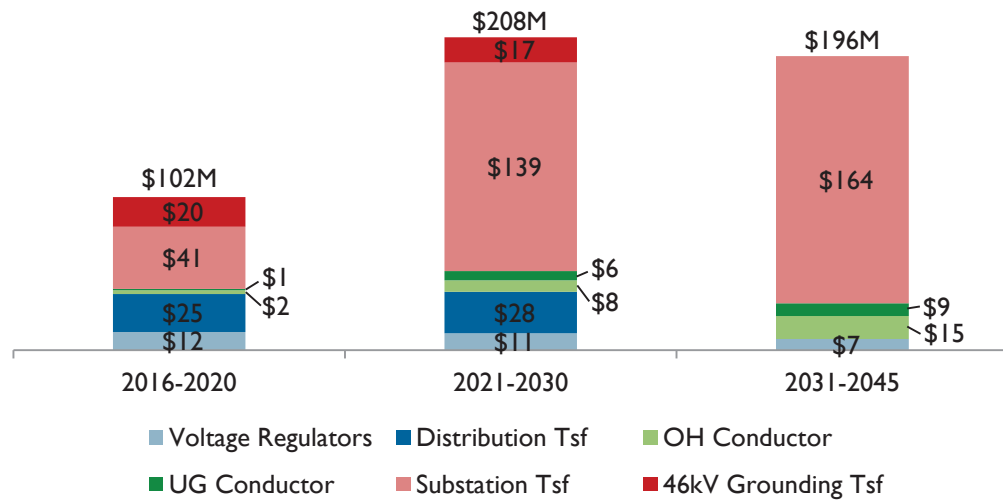

Figure N-17. Strategy 4 Annualized Integration Costs: O'ahu (Nominal \$M)

**N. Integrating DG-PV on Our Circuits**

Distribution Integration Methodology, Solutions, and Costs

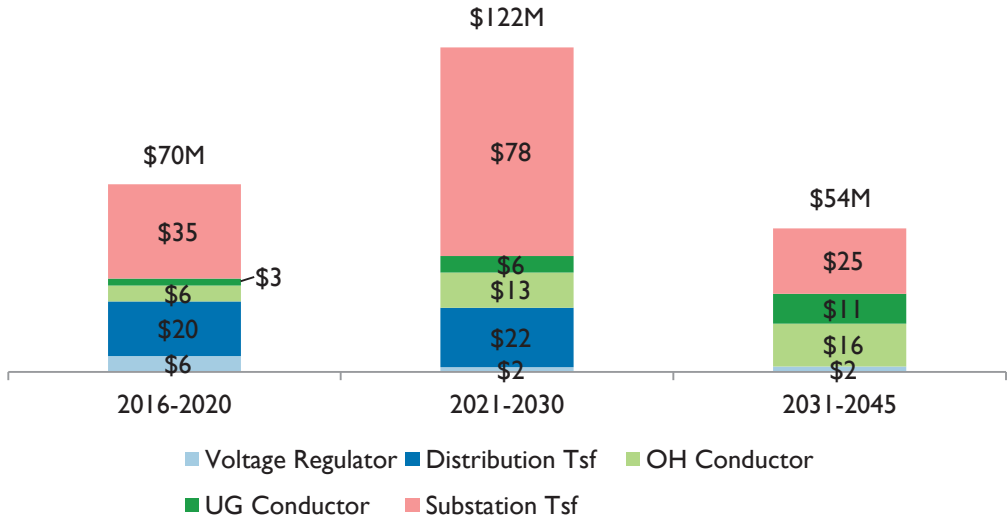

Figure N-18. Strategy 4 Annualized Integration Costs: Maui (Nominal \$M)

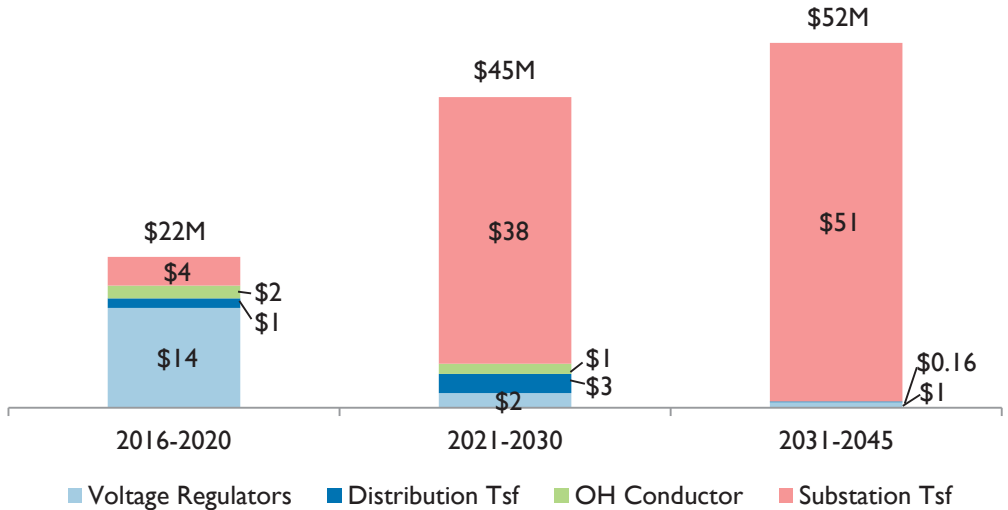

Figure N-19. Strategy 4 Annualized Integration Costs: Hawai'i Island (Nominal \$M)

**Strategy 5: Traditional or Wires Solutions with DER Controls**

This strategy applies solely in the high DG-PV case because the PV penetration in the market case does not cause any substation transformer to exceed 50% of its thermal rating. In this strategy, the reverse power from PV is operationally allowed to exceed the 50% criterion but not exceed 100% of the substation transformer’s thermal rating. In the high DG-PV case, any reverse power flow that exceeds 100% of the transformer’s thermal rating triggers a substation upgrade; this criterion significantly reduces number of substation upgrades compared to Strategy 4. To protect the distribution system from the

## N. Integrating DG-PV on Our Circuits

Distribution Integration Methodology, Solutions, and Costs

loss of operational flexibility, controllability of advanced inverters is required for PV systems that cause a violation of the operational circuit limit. Conceptually this requirement is similar to that of grid-scale resources under direct control or the system operator,<sup>12</sup> for emergency or abnormal conditions. The capability for the system operator to control these rooftop PV systems, aggregated by circuit, is essential to maintaining the operational flexibility and by extension, the safety and reliability of the distribution system.

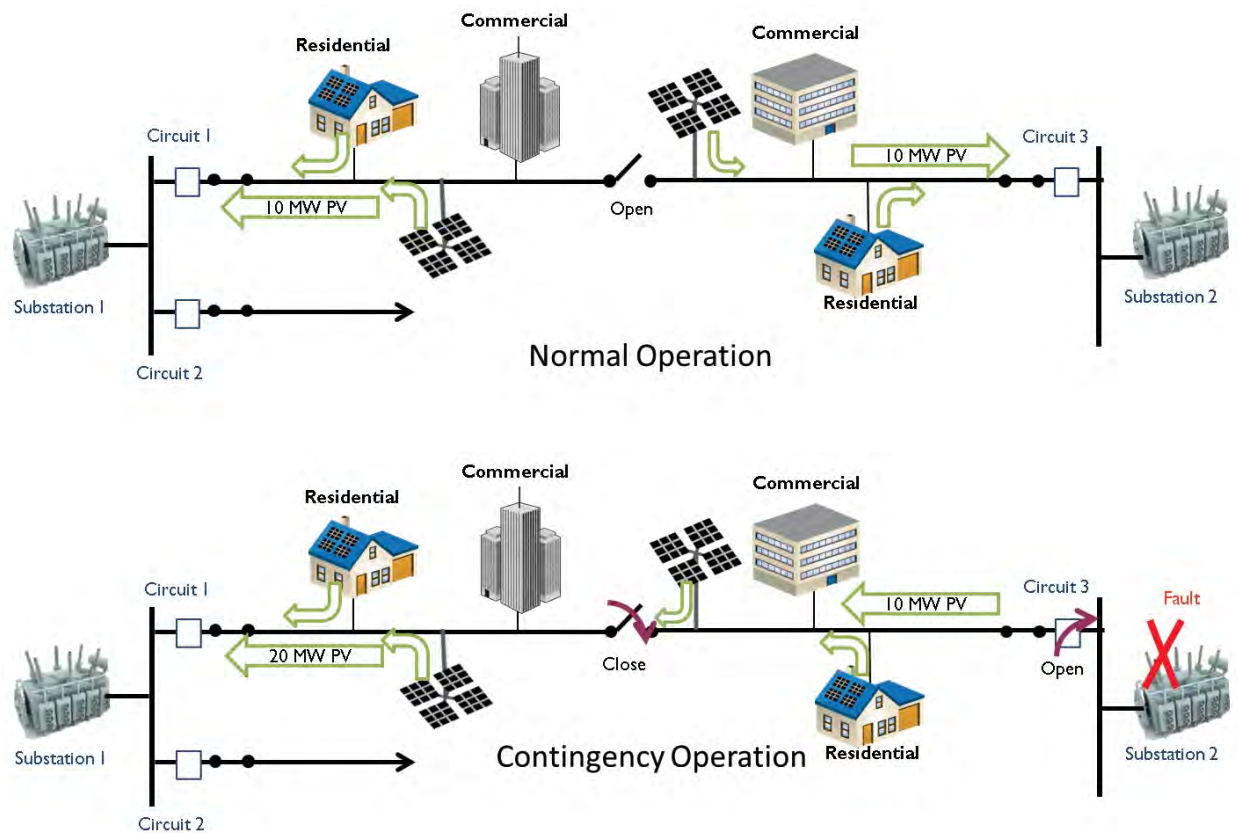

Figure N-20. Overloaded Substation During a Contingency Event (Example)

As Figure N-20 illustrates, if neighboring substations were both loaded with reverse power flow equal to 100% of their rated capacity (10 MW), and one of these substations required servicing or suffered an unplanned outage, the neighboring substation would need to provide reliable electric service to the circuit that is out of service. The out of service circuit would then be transferred to the neighboring substation transformer that remains in service to restore electric service to those customers experiencing an outage. Before doing so, the system operator would turn off the PV systems on the out of service circuit before restoring service to prevent those PV systems from turning on when service

<sup>12</sup> Per Rule 14 paragraph H, supervisory control is mandatory for generating facilities with an aggregate capacity greater than 1MW to ensure prompt response to system abnormalities, and may be required for facilities between 250 kW and 1 MW. At Maui Electric and Hawai'i Electric Light, supervisory control is mandatory for facilities 250kW and greater. See HECO, MECO, HELCO Rule 14.

**N. Integrating DG-PV on Our Circuits**

Distribution Integration Methodology, Solutions, and Costs

is restored. Failing to turn off the PV systems of the customers undergoing a transfer to the neighboring circuit may then cause an overload of 200% (20 MW) to the in-service substation transformer – the combination of the PV systems on the existing in-service circuits and the PV systems that were transferred from the now out-of-service circuits.

Figure N-21 through Figure N-23 summarize by island, the cost to integrate PV under Strategy 5: traditional solutions with DER controllability in the high DG-PV case.

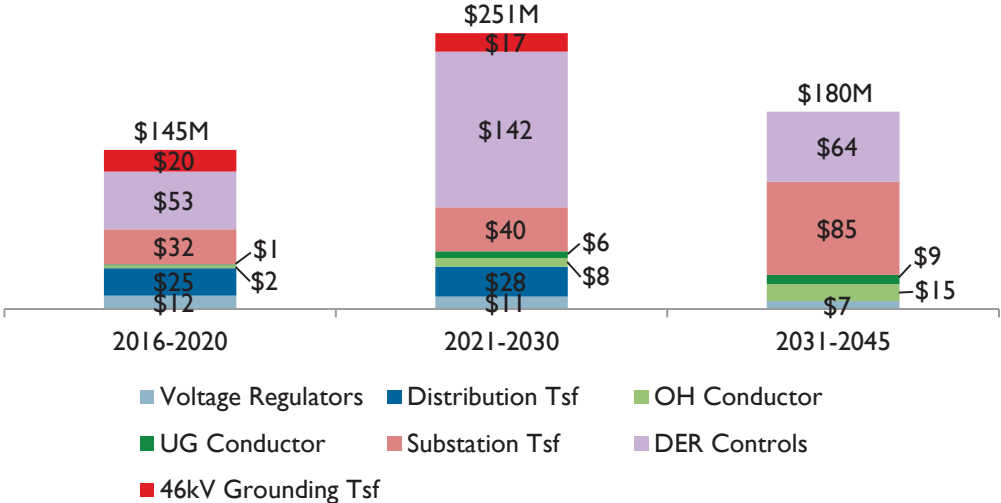

Figure N-21. Strategy 5 Annualized Integration Costs: O'ahu (Nominal \$M)

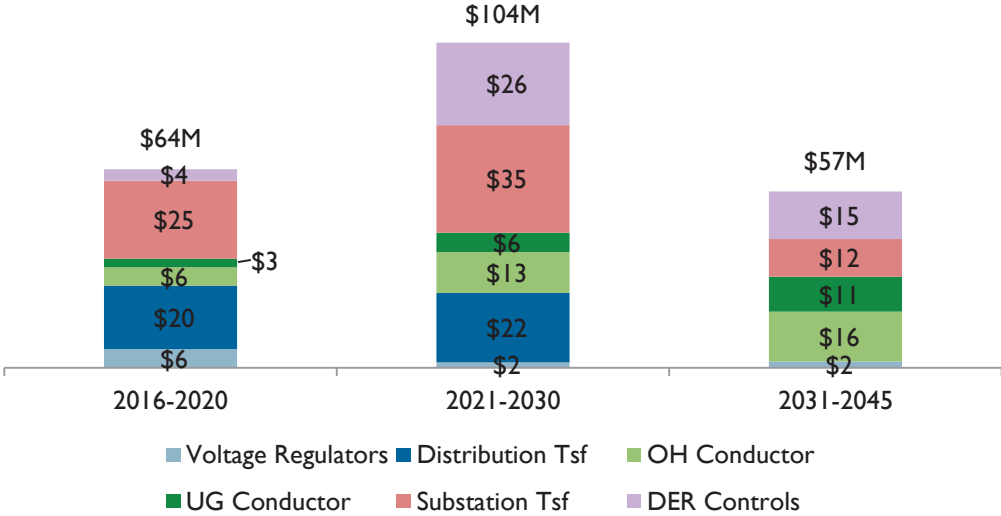

Figure N-22. Strategy 5 Annualized Integration Costs: Maui (Nominal \$M)

## N. Integrating DG-PV on Our Circuits

Distribution Integration Methodology, Solutions, and Costs

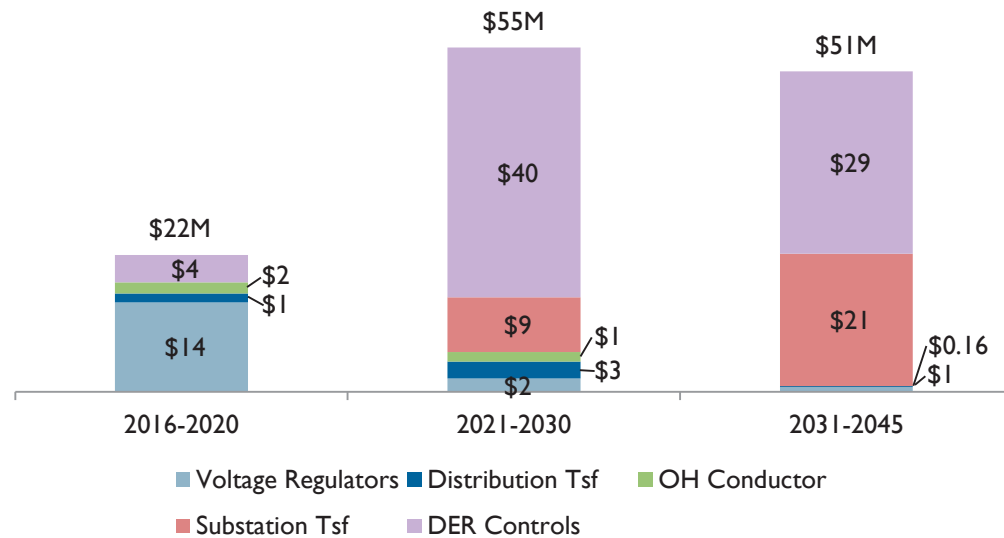

Figure N-23. Strategy 5 Annualized Integration Costs: Hawai'i Island (Nominal \$M)

### Strategy 2 and 6: Technology or Non-Wires Solutions

Technology or non-wires solutions leverage new technologies and distributed energy resources to resolve PV impacts. We utilize energy storage to store energy in excess of the operational circuit limit; thereby restoring lost operational flexibility and avoiding the installation of new circuits or substations, as indicated in Strategies 1 and 4. We also assumed that storage is strategically located on the distribution system to simultaneously alleviate overloaded conductors and service transformers.

Failure of an energy storage system that was previously relied upon to mitigate an overload, would pose a risk to the integrity of the distribution system equipment. To plan for this contingency, PV facilities should be controllable through advanced inverters by the system operators in the event that an energy storage device fails. If centralized control is unavailable, local energy management systems may autonomously manage the local energy while receiving signals from the utility during contingency operations to avoid unsafe operating conditions.

This strategy of utilizing battery energy storage systems is cost prohibitive compared to Strategies 3 and 7; however, storage may provide other ancillary benefits – such as energy shifting and frequency regulation. Battery storage would also reduce sub-transmission congestion by reducing the amount of energy exported to the sub-transmission and transmission system.

Lastly, in this strategy, var compensation devices will mitigate voltage power quality impacts. While these technologies have yet to reach widespread adoption, this distributed voltage regulation philosophy and devices may represent the future of voltage regulation and improved distribution system efficiencies.

**N. Integrating DG-PV on Our Circuits**

Distribution Integration Methodology, Solutions, and Costs

Figure N-24 through Figure N-29 summarize by island, the cost to integrate PV under Strategy 2: technology solutions in the market DG-PV case, and Strategy 4: technology solutions in the high DG-PV case.

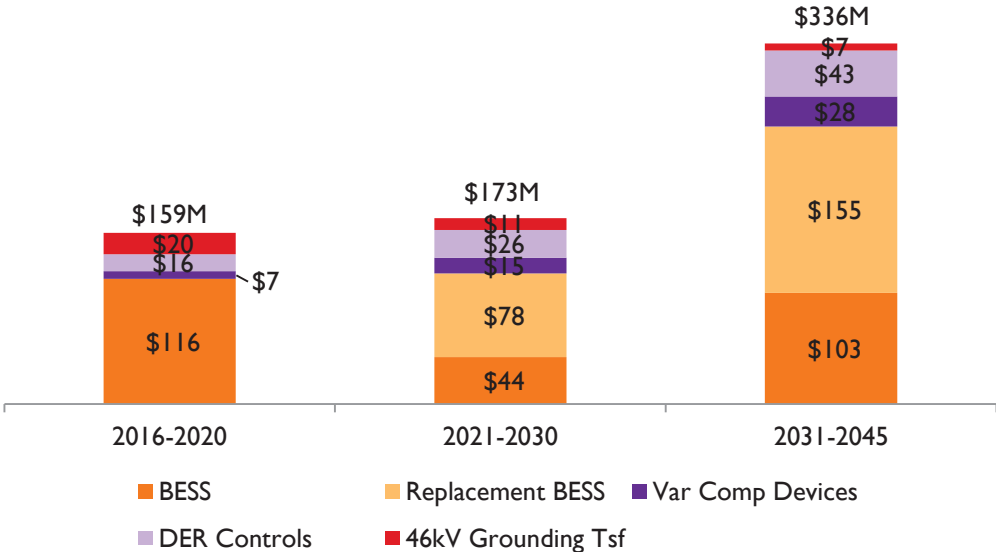

Figure N-24. Strategy 2 Annualized Integration Costs: O'ahu (Nominal \$M)

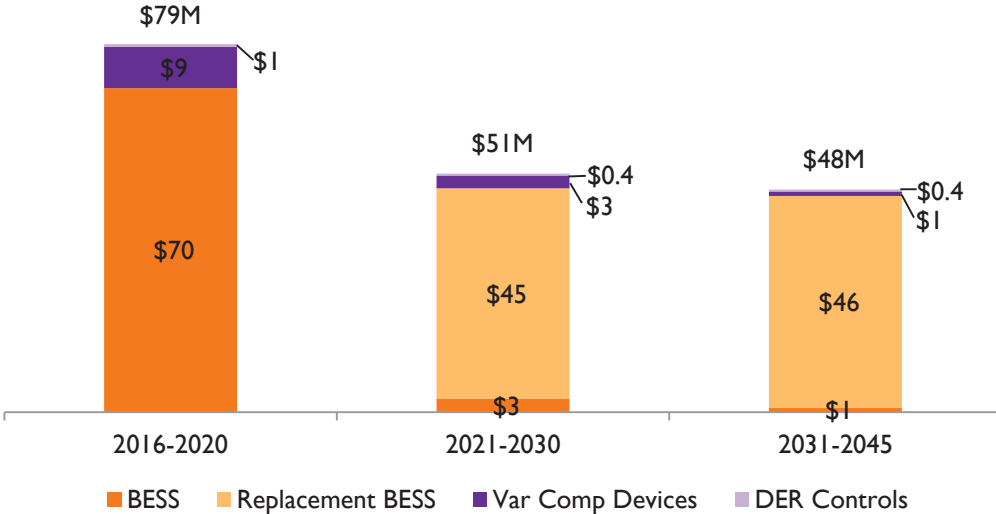

Figure N-25. Strategy 2 Annualized Integration Costs: Maui (Nominal \$M)



## N. Integrating DG-PV on Our Circuits

Distribution Integration Methodology, Solutions, and Costs

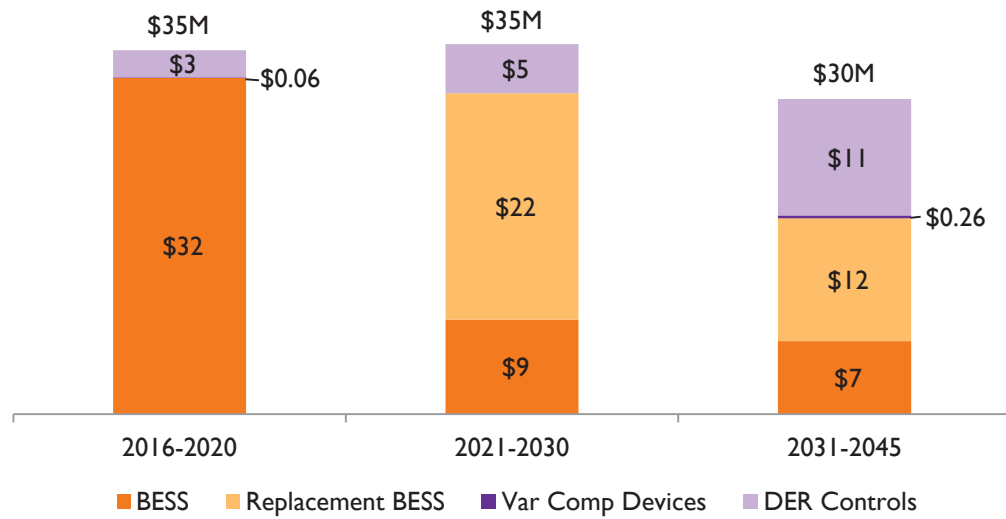

Figure N-26. Strategy 2 Annualized Integration Costs: Hawai'i Island (Nominal \$M)

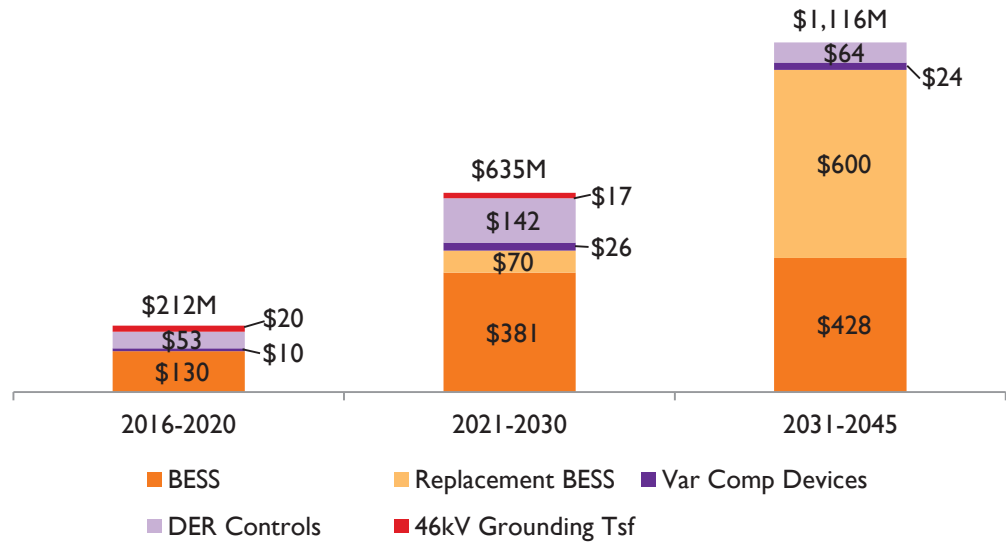

Figure N-27. Strategy 6 Annualized Integration Costs: O'ahu (Nominal \$M)

**N. Integrating DG-PV on Our Circuits**

Distribution Integration Methodology, Solutions, and Costs

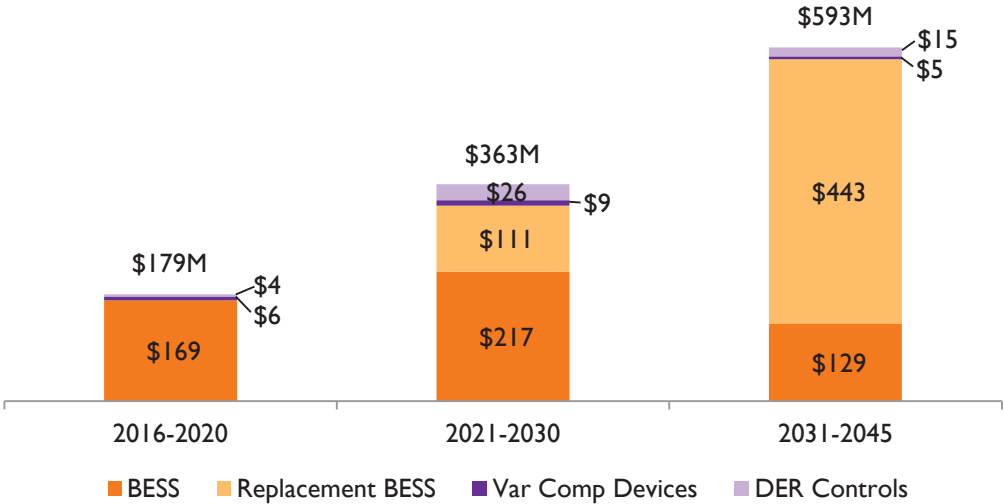

Figure N-28. Strategy 6 Annualized Integration Costs: Maui (Nominal \$M)

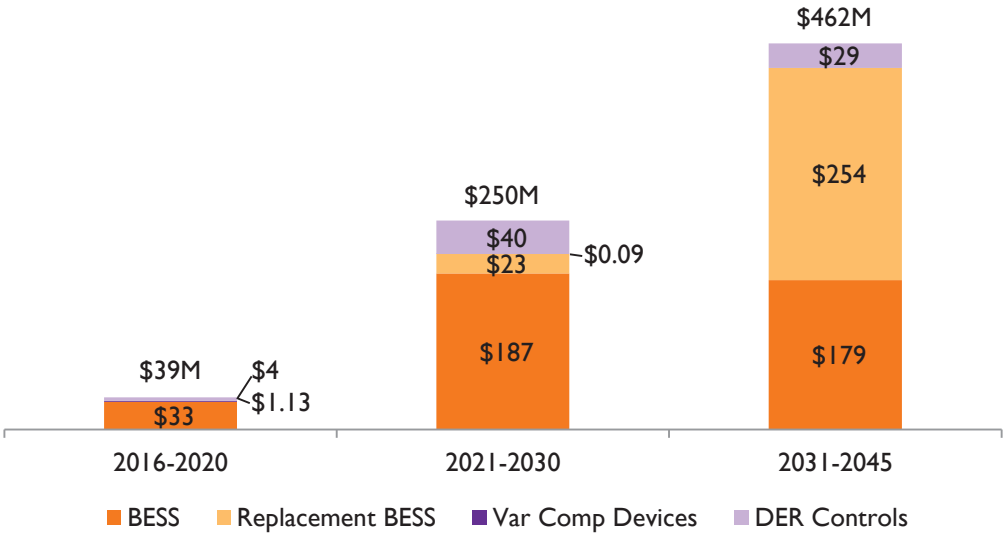

Figure N-29. Strategy 6 Annualized Integration Costs: Hawai'i Island (Nominal \$M)

**Strategy 3 and 7: Least Storage Solution with Advanced Inverter Controls**

This strategy is a variation of the technology solutions described in Strategy 2 and Strategy 6, with the exception that operational flexibility is not maintained during normal conditions, similar to Strategy 5. In this strategy, the analysis demonstrates that storage is not required in the market DG-PV case and minimal storage in the high DG-PV case; however direct control of the PV facilities through the use of advanced inverter controls is required to allow the system operator to restore the operational flexibility when

## N. Integrating DG-PV on Our Circuits

Distribution Integration Methodology, Solutions, and Costs

needed (that is, outage event). Sub-transmission congestion is increased under this strategy but manageable with advanced inverter controls.

There is the potential for increased curtailment of distributed resources in these strategies but we are unable to quantify those amounts at this time, as it is highly dependent on the location of the DER assets.

Potential conductor upgrades are still required to avoid overloads, which is relatively low cost compared to storage as an alternative. Future energy management system technology is assumed to manage service transformer overloads. This measure of control can avoid service transformer replacements, and is reflected in the cost estimate of these strategies.

In the first 2 to 3 years of this strategy, voltage regulators and substation transformers are required at which time those solutions are phased out and replaced with advanced inverter controllability and var compensation devices.

Figure N-30 through Figure N-35 summarize by island, the cost to integrate PV under Strategy 3 and Strategy 7: least storage solution with advanced inverter controls.

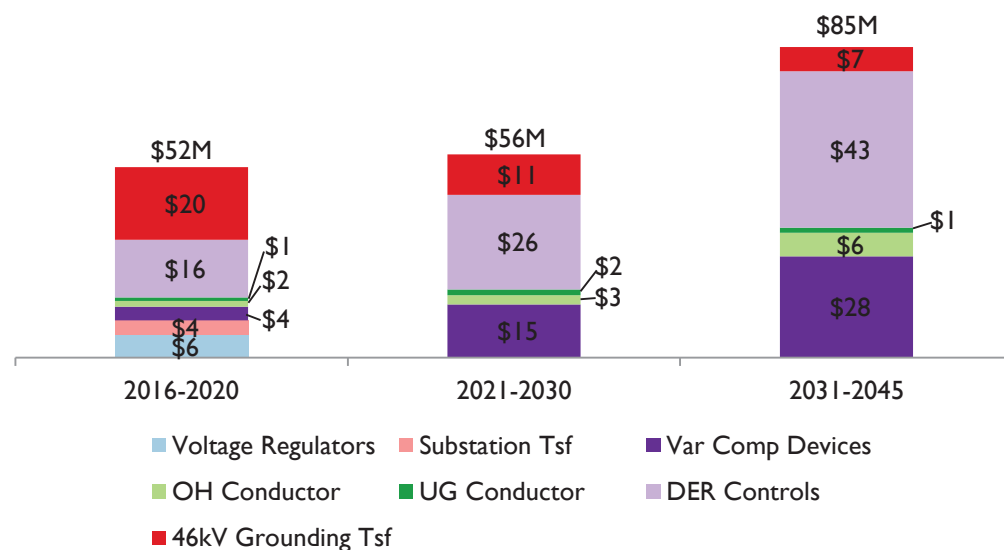

Figure N-30. Strategy 3 Annualized Integration Costs: O'ahu (Nominal \$M)

**N. Integrating DG-PV on Our Circuits**

Distribution Integration Methodology, Solutions, and Costs

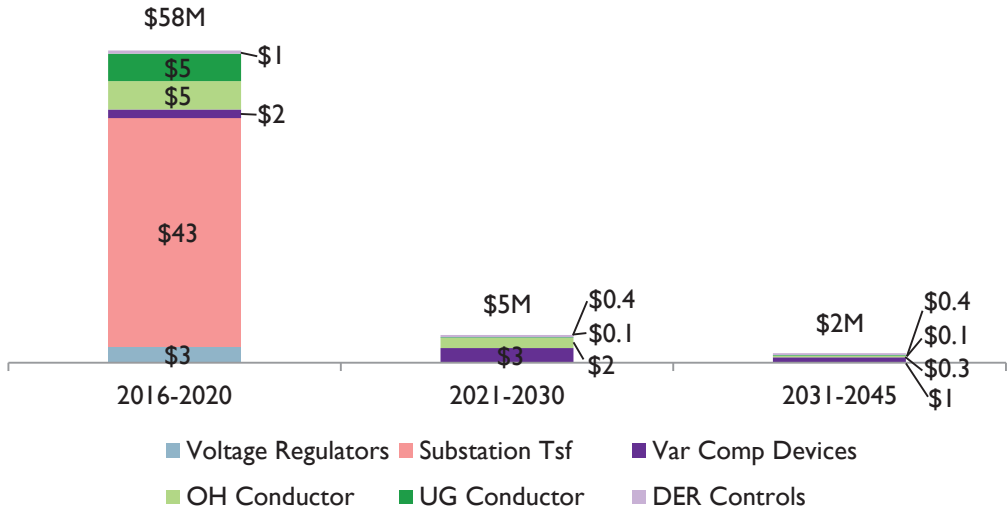

Figure N-31. Strategy 3 Annualized Integration Costs: Maui (Nominal \$M)

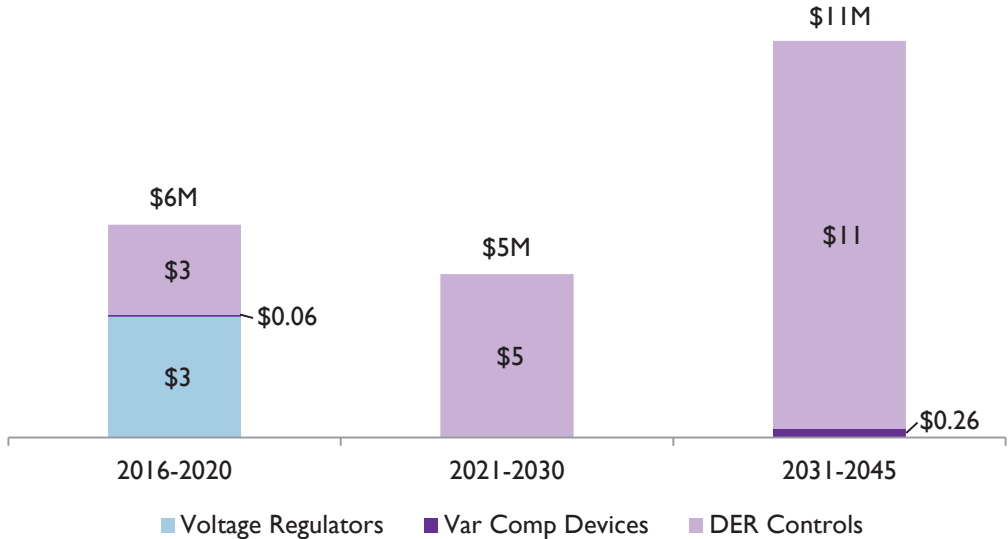

Figure N-32. Strategy 3 Annualized Integration Costs: Hawai'i Island (Nominal \$M)

## N. Integrating DG-PV on Our Circuits

Distribution Integration Methodology, Solutions, and Costs

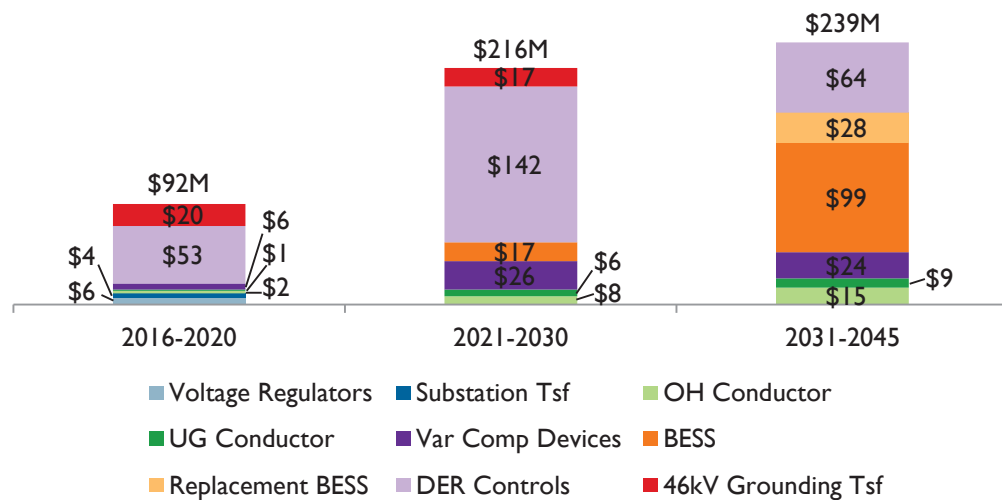

Figure N-33. Strategy 7 Annualized Integration Costs: O'ahu (Nominal \$M)

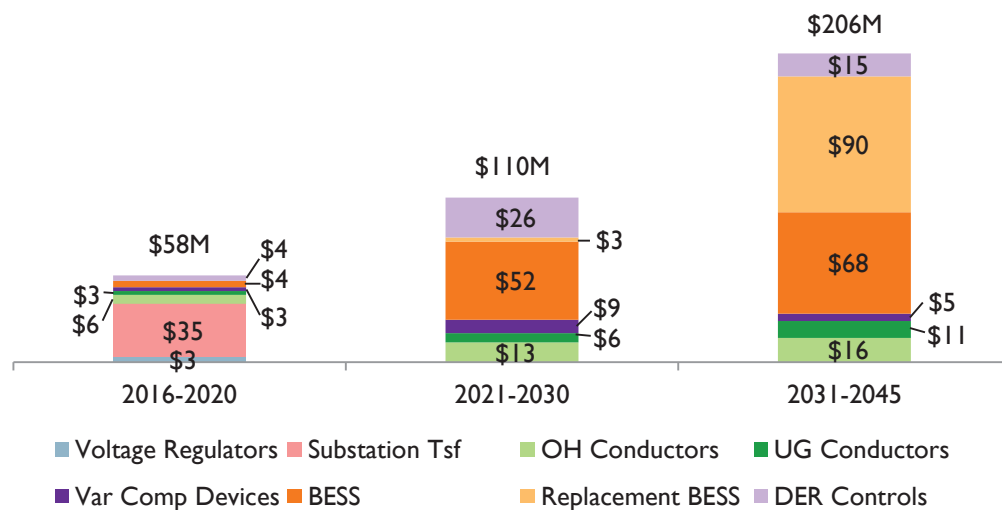

Figure N-34. Strategy 7 Annualized Integration Costs: Maui (Nominal \$M)

**N. Integrating DG-PV on Our Circuits**

Distribution Integration Methodology, Solutions, and Costs

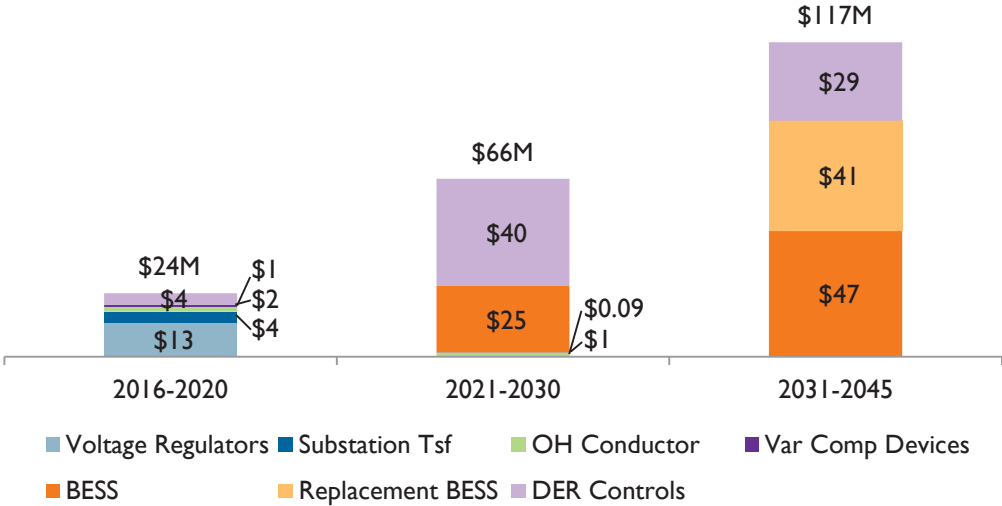

Figure N-35. Strategy 7 Annualized Integration Costs: Hawai'i Island (Nominal \$M)

**Results of Integration Cost Analysis**

Figure N-36 and Figure N-37 show the comparative costs for the different integration strategies for both the market and high DG-PV case per island in nominal dollars with a 1.8% escalation rate.

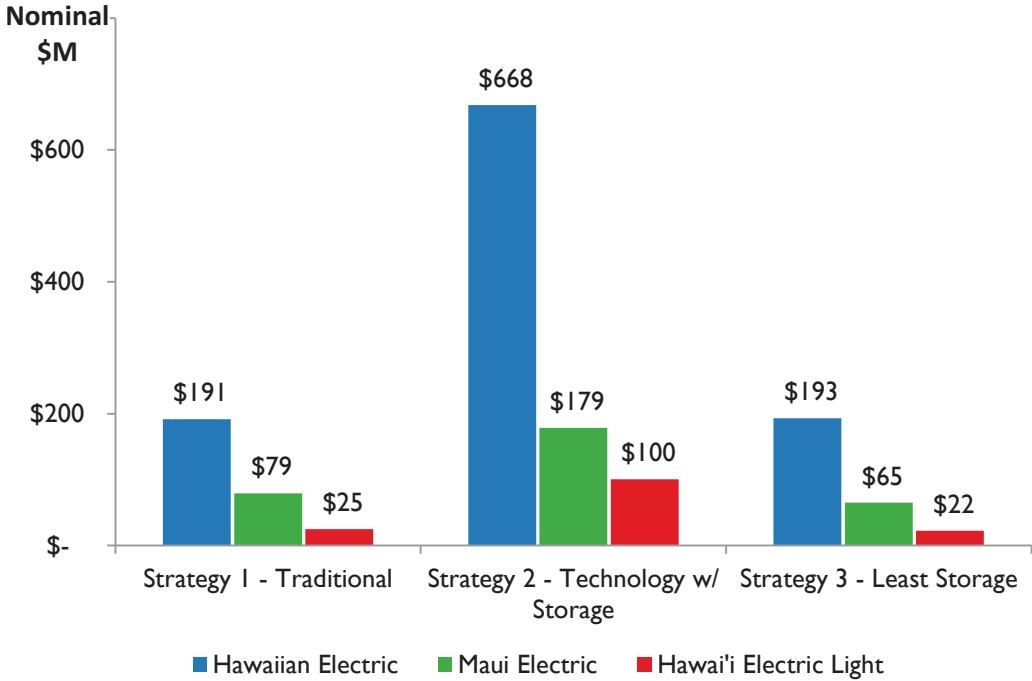

Figure N-36. Market DG-PV Forecast Total Integration Cost by Strategy by Island

## N. Integrating DG-PV on Our Circuits

Distribution Integration Methodology, Solutions, and Costs

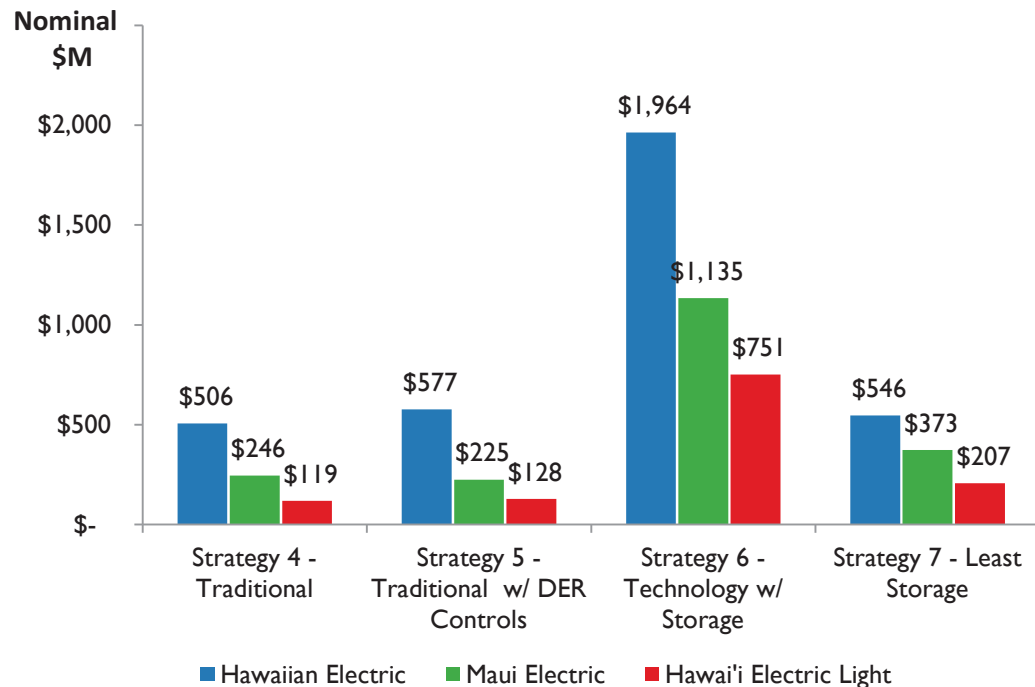

Figure N-37. High DG-PV Forecast Integration Cost by Strategy by Island

When viewing the 30-year planning horizon, the least storage option is cost competitive, relative to the other options, across the three islands in the market DG-PV case (for O‘ahu the “traditional” strategy has a negligible cost difference when compared to the “least storage” strategy). However, in the high DG-PV case, the traditional integration strategy is the least cost strategy across the three islands. The least storage strategy becomes the most cost-effective if the cost to implement advanced inverter DER controls is significantly lower than that assumed in this analysis.

Distribution system planning typically tracks on 5- and 10-year planning horizons. With the on-going reform of distributed energy resource tariffs, factors such as, time of use, demand response, and electric vehicles make it difficult to predict future customer load shapes of residential and commercial circuits. The hosting capacity and resulting costs are sensitive to loading conditions coincident with PV production. The near-term 5-year integration costs provide a more accurate near-term assessment of the expected distribution system impacts.

As shown in Figures N-10 through N-12, the five-year DG-PV forecast in both the market and high-PV cases, remain relatively unchanged from the April 2016 PSIP Update. Table N-9 summarizes the near-term capital expenditures for each strategy in the April 2016 market DG-PV case, indicating that the least storage strategy is the least cost strategy.

**N. Integrating DG-PV on Our Circuits**

Distribution Integration Methodology, Solutions, and Costs

Island Grid	Strategy 1	Strategy 2	Strategy 3	Forecasted PV
O'ahu	\$64M	\$159M	\$52M	608 MW
Maui	\$62M	\$79M	\$58M	125 MW
Hawai'i Island	\$9M	\$35M	\$6M	112 MW

Table N-9. Near-Term Cost Comparison, Market PV Strategies, 2016-2020

Table N-9 summarizes the near-term capital expenditures for each strategy in the April 2016 high-PV case, indicating that the traditional wires and least storage strategies are the least cost strategies to integration in the near-term. However, because control capability of the inverters are required to execute Strategy 7, traditional wires solutions are likely the most feasible in the very near-term.

Island Grid	Strategy 4	Strategy 5	Strategy 6	Strategy 7	Forecasted PV
O'ahu	\$102M	\$145M	\$212M	\$92M	572 MW
Maui	\$70M	\$64M	\$179M	\$58M	126 MW
Hawai'i Island	\$22M	\$22M	\$39M	\$24M	113 MW

Table N-10. Near-Term Cost Comparison, High-PV Strategies, 2016-2020

It is likely that a mix of solutions from different strategies resolves various integration issues in the near-term. We prioritize solutions that meet near-term interconnection needs but are also useful in the long term. These analyses represent a sound guide to the capital investments required to integrate various levels of DG-PV when considering a portfolio of solutions.

Full tabular results of the various strategies are provided “Integration Strategy Cost Estimates” (page N-99), including integration results for Lana‘i and Moloka‘i.

**Step 5: Derive Integration Cost Estimates**

The following cost curves (Figure N-38 through Figure N-43) specified in real or constant 2016-dollar terms define the relationship between total DG-PV megawatts interconnected and the associated integration costs. These cost curves can estimate the integration costs for a range of DG-PV with proper escalation rates applied.



## N. Integrating DG-PV on Our Circuits

Distribution Integration Methodology, Solutions, and Costs

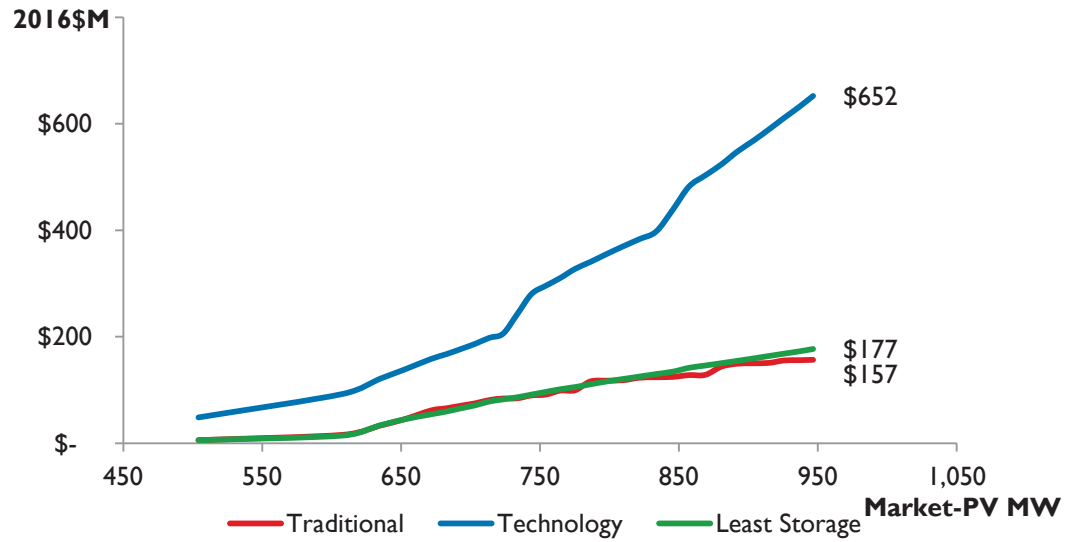

Figure N-38. Market DG-PV Integration Cost Curve by Strategy: O'ahu (Real \$M)

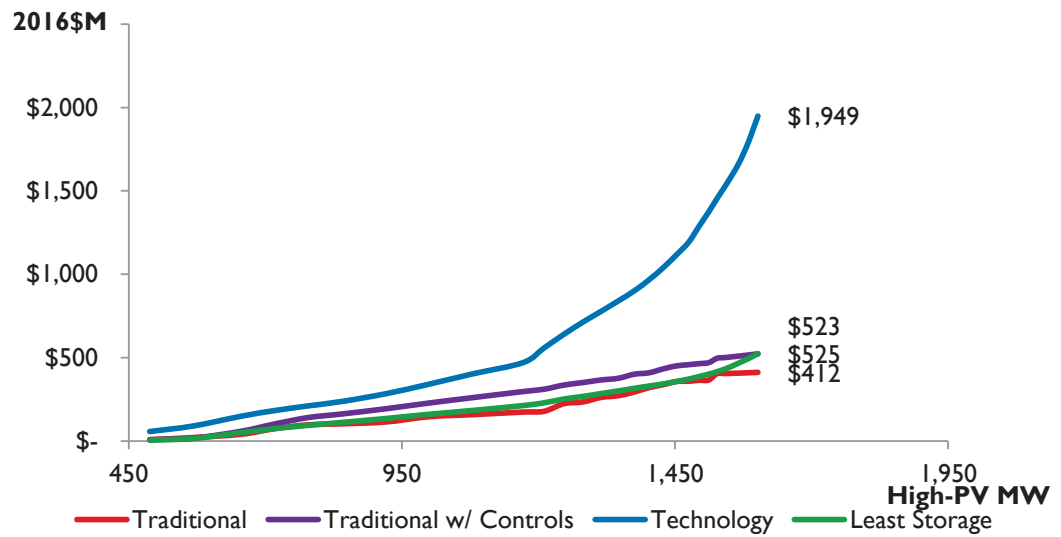

Figure N-39. High DG-PV Integration Cost Curve by Strategy: O'ahu (Real \$M)

**N. Integrating DG-PV on Our Circuits**

Distribution Integration Methodology, Solutions, and Costs

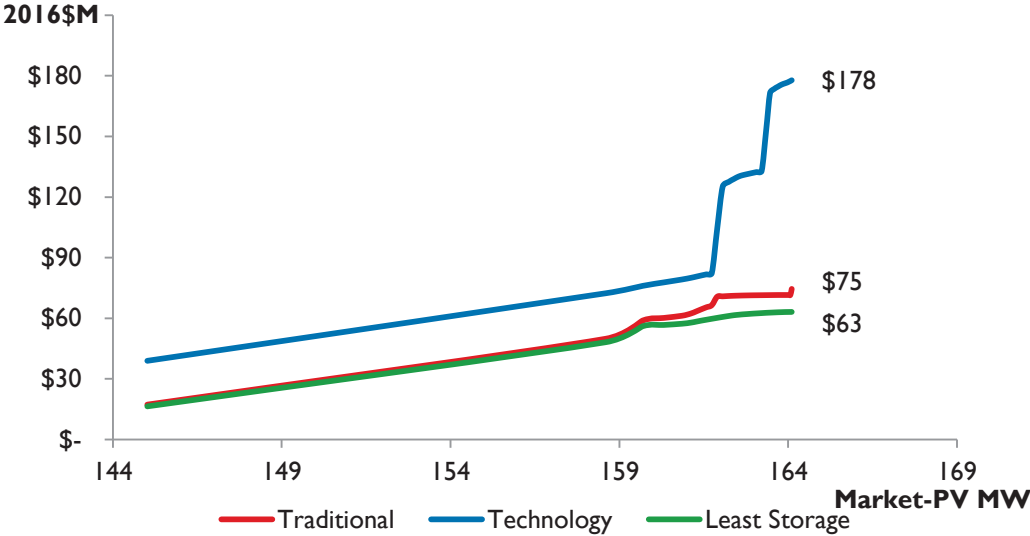

Figure N-40. Market DG-PV Integration Cost Curve by Strategy: Maui (Real \$M)

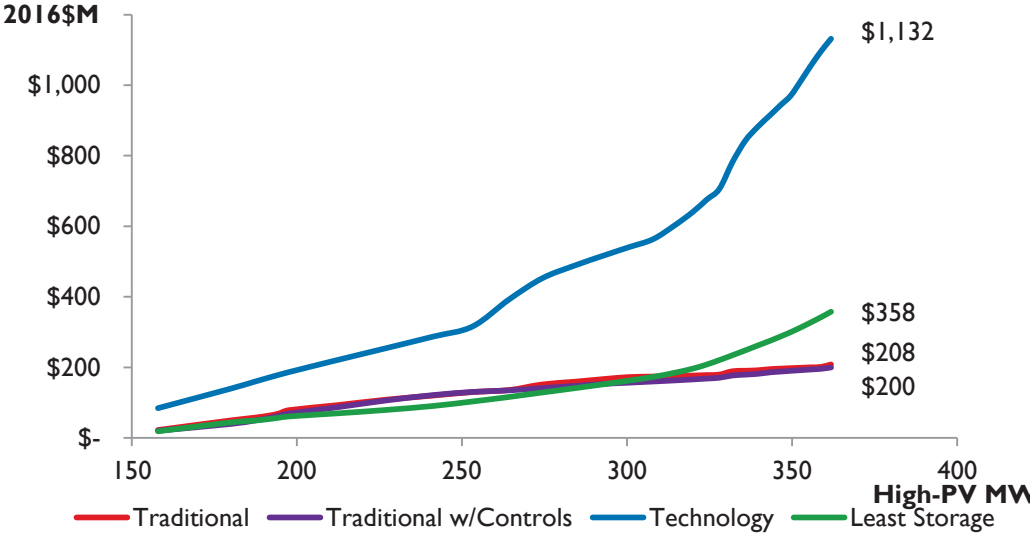

Figure N-41. High DG-PV Integration Cost Curve by Strategy: Maui (Real \$M)

## N. Integrating DG-PV on Our Circuits

Distribution Integration Methodology, Solutions, and Costs

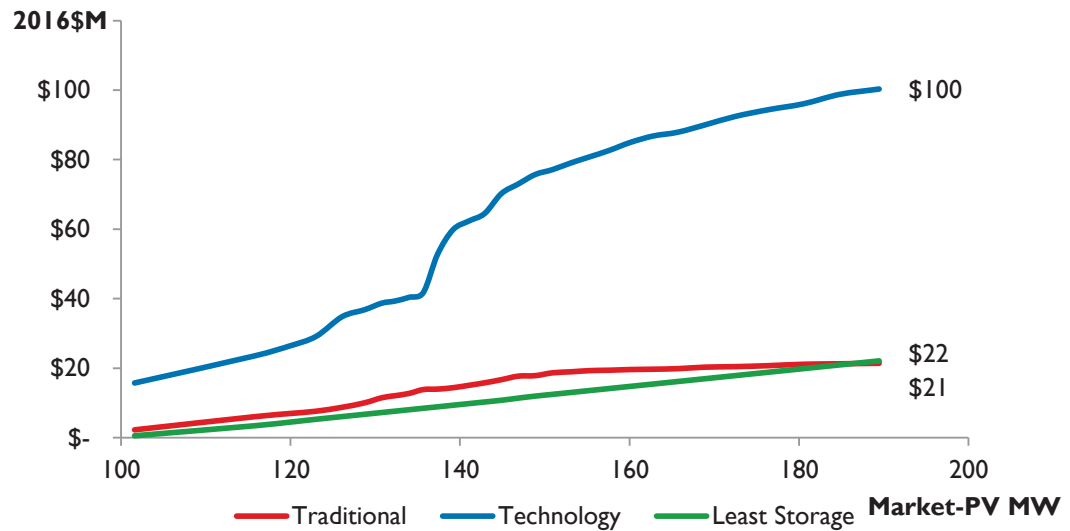

Figure N-42. Market DG-PV Integration Cost Curve by Strategy: Hawai'i Island (Real \$M)

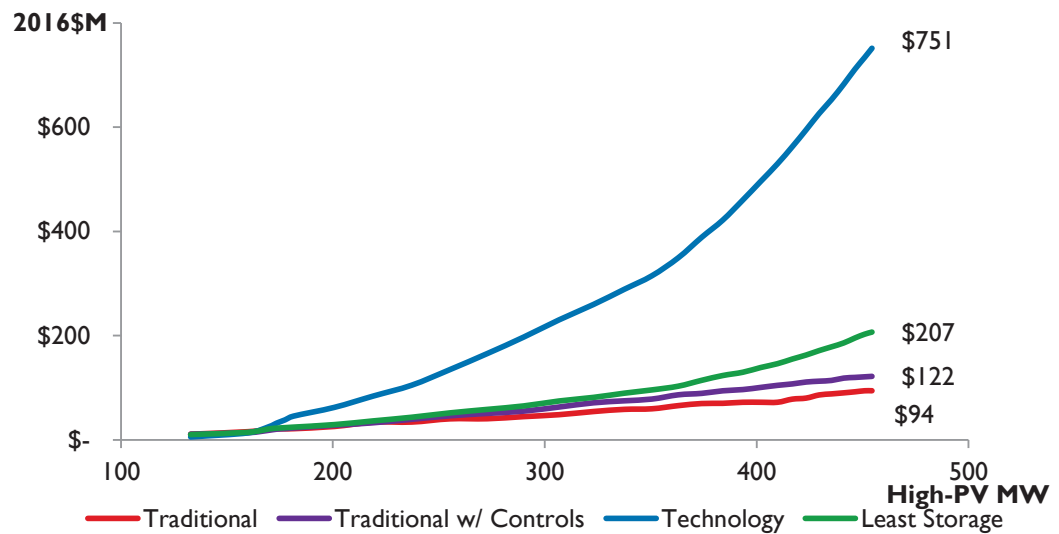

Figure N-43. High DG-PV Integration Cost Curve by Strategy: Hawai'i Island (Real \$M)

### DG-PV Integration Progress

Since the DGIP filing in 2014, we have upgraded 64 load tap changer controllers on O'ahu, totaling \$380,000, which modernized our voltage regulation equipment to accommodate reverse power flow. We have completed research on ground fault overvoltage and no longer require grounding transformers at the distribution level.<sup>13</sup>

<sup>13</sup> Concerns, however, do remain with ground fault overvoltage on the sub-transmission (46kV) level. The 67 grounding transformers (totaling \$4.4M) at Maui Electric and the 16 grounding transformers (totaling \$1.1M) on Hawai'i Electric

## N. Integrating DG-PV on Our Circuits

Distribution Integration Methodology, Solutions, and Costs

In 2016, to address the backlog of net energy metering customers and to increase overall circuit hosting capacities, we have executed meaningful circuit upgrades to facilitate DG-PV interconnection. Using our circuit models, hosting capacity simulations, and field data, we were able to determine primary system mitigations. Table N-11 describes the progress to-date in our efforts to prepare for future integration efforts.

Circuit Name	Primary System Violation	Solution
Circuit 2	High Voltage	Varentec pilot
Circuit 8	High Voltage	Optimized LTC settings
Circuit 27	High Voltage	4KV conversion, phase balancing and optimize LTC settings.
Circuit 49	High Voltage	Varentec pilot
Circuit 56	High Voltage	Re-configure circuit to phase balance and optimized LTC settings
Circuit 74	High Voltage	Optimized LTC and regulator settings
Circuit 78	High Voltage	Optimized LTC settings and phase balancing
Circuit 79	High Voltage	Solution pending
Circuit 93	High Voltage	Replace 3 voltage regulators, optimize regulator settings
Circuit 104	High Voltage	4KV conversion, phase balancing and optimize LTC settings.
Circuit 107	High Voltage	Optimize voltage regulator settings
Circuit 168	High Voltage	Optimized LTC settings
Circuit 186	High Voltage	Re-configure circuit to phase balance and optimized LTC settings
Circuit 192	High Voltage	Re-configure circuit to phase balance and optimized LTC settings
Circuit 228	High Voltage	Optimize voltage regulator settings
Circuit 258	High Voltage	Optimized LTC settings
Circuit 259	High Voltage, Thermal Overload	Upgrade conductor, optimize LTC settings
Circuit 285	High Voltage	Optimized LTC settings
Circuit 300	High Voltage	Optimized LTC and regulator settings
Circuit 327	High Voltage	Optimized LTC settings
Circuit 342	High Voltage	Optimized LTC settings
Circuit 359	High Voltage	Optimized LTC settings
Circuit 360	High Voltage	Optimized LTC settings
Circuit 361	High Voltage	Optimized LTC settings
Circuit 381	High Voltage	Optimized LTC settings

Table N-11. O'ahu Distribution System DG-PV Primary Mitigation Efforts

The majority of solutions to-date optimized LTC settings. We are in the process of quantifying the resulting increase in hosting capacity; however, the next DG-PV program

---

Light, as stated in the DGIP, are no longer required in most situations provided PV systems meet our current transient overvoltage standards. See DGIP at 3-6.

## N. Integrating DG-PV on Our Circuits

### Sub-Transmission Integration Methodology, Solutions, and Costs

will likely require additional solutions to solve high and low voltage deviations. As discussed in earlier sections, a mix of solutions such as, advanced inverter voltage functions, var compensation devices, conductor upgrades, and voltage regulators are key components to our future voltage regulation strategy.

---

## SUB-TRANSMISSION INTEGRATION METHODOLOGY, SOLUTIONS, AND COSTS

With over 2,000 MW of rooftop PV and more than 1800 MW of grid-scale solar forecasted to interconnect to the grid, integration impacts are expected on the sub-transmission system.

The sub-transmission capacity analysis will determine (1) the impact of rooftop PV to the sub-transmission system, and (2) the impact of future grid-scale wind and solar projects to the sub-transmission system.

The sub-transmission hosting capacity will analyze each line section to determine the amount of generation that can interconnect before triggering a criteria violation. The analysis is intended to provide regulators, policymakers, and energy developers information on the available capacity in various regions throughout the island.

### Methodology

Voltage power quality and equipment thermal capacity of the sub-transmission lines were the focus of the initial iteration of the sub-transmission hosting capacity. Many other PV or wind generation impacts are specific to the size of the proposed grid-scale project, its operating characteristics, and its point of interconnection. A specific project's Interconnection Requirements Study will evaluate other potential impacts.

Sub-Transmission Hosting Capacity was determined by performing a steady-state load flow with Synergi Electric Software. Synergi created the Section Incremental Hosting Capacity tool specific for performing sub-transmission hosting capacity.

Within the load flow model, we allocated the circuit daytime minimum load at each Distribution Substation Transformer, along with its forecasted PV amount from the April 2016 market forecast and known grid-scale projects through 2019.

Table N-12 describes the criteria used in this analysis based upon Hawaiian Electric’s sub-transmission planning criteria.

Parameter	Criteria
Voltage	+4.34% to -10% of nominal
Conductor Loading	100% of the normal ampacity rating of the conductor
Transformer Loading	During normal loading conditions, 100% of the zero percent loss-of-life kVA capability, which is normally at least the nameplate rating of the transformer.

Table N-12. Sub-Transmission Hosting Capacity Criteria

The voltage criterion is much wider in comparison to the distribution system ( $\pm 5\%$  of nominal) because the majority of customers are located on the distribution system, and voltage is regulated at downstream regulation devices.

**Voltage and Capacity**

Figure N-44 depicts a simple representation of a generic sub-transmission circuit, which shows the sub-transmission line typically connected to our transmission substation transformers with a voltage rating of 138,000 volts to 46,000 volts. In the model, each sub-transmission line is broken up into sections.

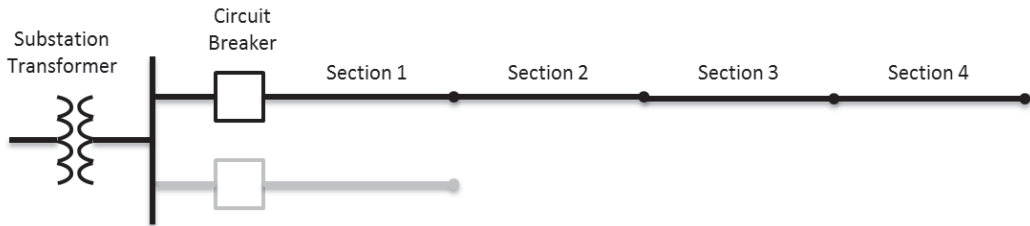

Figure N-44. Simplified Representation of Generic Sub-Transmission Circuit

The following describes the sub-transmission hosting capacity process:

1. Place a distributed generator one section at a time, with an initial size of 1 kW, starting with Section 1.
2. Increase generator size on section until violation of any of the criteria described in Table N-12 occurs.
3. Record maximum generator size without any violations. This is the available hosting capacity for that line section.
4. Remove generator from Section.
5. Repeat process for next sub-transmission line section.

## N. Integrating DG-PV on Our Circuits

Sub-Transmission Integration Methodology, Solutions, and Costs

Figure N-45 illustrates the simplified output of a sub-transmission analysis.

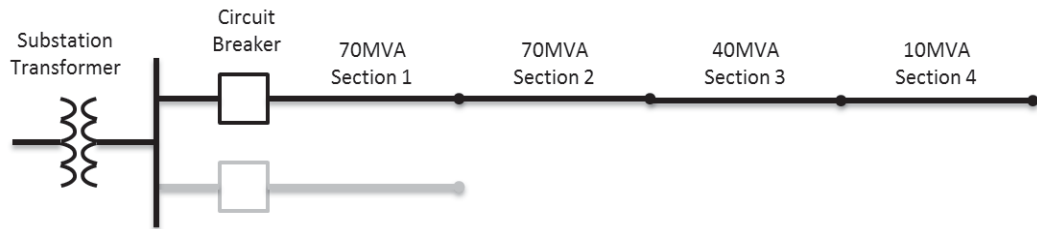

Figure N-45. Simplified Results of the Section Incremental Capacity Tool

The available hosting capacity only applies to the first project placed onto a sub-transmission line beyond the base case. Each time a project is or proposed to be interconnected; the hosting capacity must be re-run with the new base case to determine the available hosting capacity for future projects. The available capacity is highly dependent on a project's point of interconnection.

During the procurement process, an Interconnection Requirements Study will resolve any impacts associated with multiple projects interconnecting to the same sub-transmission line.

### Results

The sub-transmission hosting capacity analysis included the April 2016 market forecast of 971 MW. In comparison to the current high DG-PV forecast, 971 MW is the expected level of PV adoption in 2027. The next iteration of the sub-transmission hosting capacity will update the model with the most current distributed PV forecast.

Based upon 971 MW of distributed PV, the analysis shows a Wahiawa sub-transmission conductor overload for 17 miles. The wind farms located on the north shore consume the majority of the capacity on this line. Further, the overloaded portions of the sub-transmission line already have the largest available overhead 46,000-volt conductor installed. Notwithstanding the Wahiawa transmission constraint, additional transmission infrastructure will be required on the central and north side of the island to expand renewable energy development. In its current state, additional rooftop PV and grid-scale resources are severely capacity limited on the north side of the island.

Utilizing the preliminary sub-transmission hosting capacity analysis, we calculated each sub-transmission line PV penetration as a function of its daytime minimum load. PV penetration of daytime minimum load in excess of 120% served as a proxy to determine the likelihood of ground fault overvoltage. As shown in Figure N-46, 35 of the 58 circuits will potentially require ground fault overvoltage mitigation based on the 2045 April 2016 market forecast. An Interconnection Requirements Study will determine the timing, and whether mitigation is required because ground fault overvoltage is dependent on the

amount of load, nameplate generation, equipment ratings, and impedance of the circuit; each case is unique.

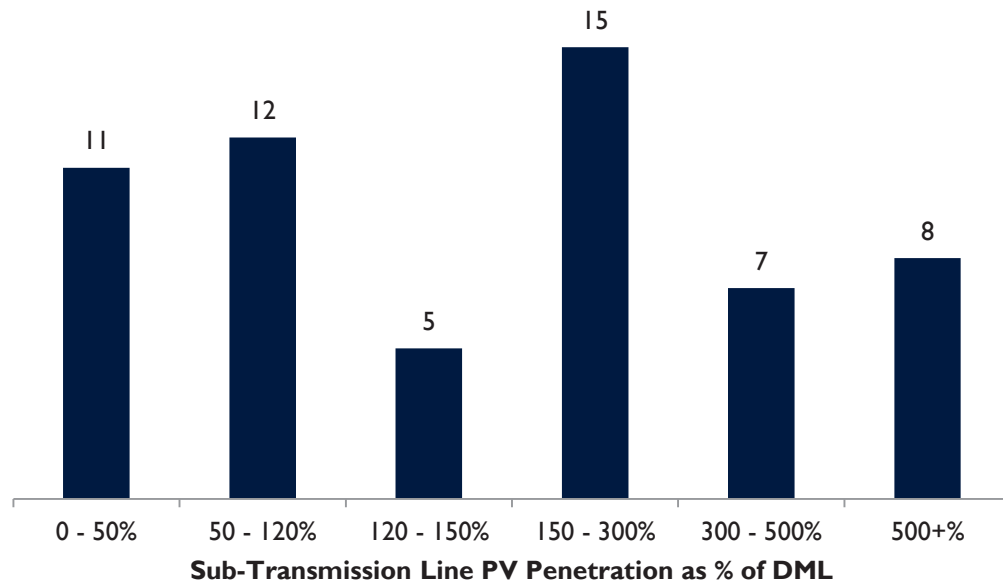

Figure N-46. Number of Sub-Transmission Circuits by Percentage of Daytime Minimum Load

### Solutions and Costs

Accurate estimates of the scope and cost of potential mitigations at the sub-transmission level rely heavily on the location and the operation of the generating resource. This section intends to discuss solutions, and where possible quantifying those costs. The actual mitigations and costs are determined through detailed analysis such as an Interconnection Requirements Study.

#### *Conductor and Equipment Overload*

Grid-scale projects can expect to face sub-transmission conductor upgrades, particularly in the high solar potential areas determined in NREL’s analysis. Projects interconnecting farther from the substation tend to require capacity upgrades because of the smaller conductors typically installed. The largest overhead sub-transmission conductor has a capacity of 55 MVA, and transmission substation transformers (138,000 volts to 46,000 volts) have a maximum rating of 80 MVA.

These sub-transmission limitations drive the need to expand existing transmission infrastructure to increase capacity for grid-scale projects.

It is difficult to estimate the quantity of conductor upgrades; however, the sub-transmission hosting capacity serves as a tool to determine remaining capacity. Projects



## N. Integrating DG-PV on Our Circuits

Sub-Transmission Integration Methodology, Solutions, and Costs

requiring a conductor upgrade, can expect to pay approximately \$3.4M per mile of overhead 46,000-volt conductor.

### Ground Fault Overvoltage

Table N-13 tabulates the quantity and cost of expected grounding transformer upgrades required by 2045 using the April 2016 market forecast.

Grounding Transformer	2016–2020	2021–2030	Total
Quantity	20	15	35
Cost (\$MM)	\$19	\$14.25	\$33.25

Table N-13. Grounding Transformer Requirements, High DG-PV Forecast

Hawaiian Electric modified their interconnection requirements for grid-scale resources to require interconnection transformers (delta to grounded wye) that provide effective grounding. Less grounding transformers than estimated here would be required if a sub-transmission line is effectively grounded by a grid-scale resource.

## Near-Term Sub-Transmission and Transmission Constraints

\* Based on Wahiawa transmission constraint of 94 MW less FIT-3 and Waiver Projects (85 MW), Wahiawa Sub-Transmission Lines are limited to 9 MW.

Table N-14 below summarizes the transmission constraints on all three major islands.

Island	Area	MW Capacity
O'ahu (Sub-Transmission)	Wahiawa*	9
	Waiau-Mililani	70
	Kahe 1	24
	Kahe 2	42
	Ewa	81
O'ahu (Transmission)	Kahe Bus	209
Maui (Transmission)	South Maui	15
	Kaheawa	115
Hawai'i Island (Transmission)	Lalamilo	70

\* Based on Wahiawa transmission constraint of 94 MW less FIT-3 and Waiver Projects (85 MW), Wahiawa Sub-Transmission Lines are limited to 9 MW.

Table N-14. High-Level Estimate of Transmission and Sub-Transmission Constraints, by Island.

### Near-Term O'ahu Sub-Transmission Constraints

Figure N-47 details the hosting capacity analysis of the sub-transmission lines in the areas of grid-scale solar potential as analyzed by NREL (See Appendix F: NREL Reports). This analysis estimates the amount of available capacity to integrate grid-scale resources by 2020 without having to perform conductor upgrades. Each high solar potential region

has a range of available capacity; the actual available capacity is dependent upon the point of interconnection. Capacity values were determined by aggregating the individual capacity of sub-transmission lines that pass near or through the brown and orange shaded solar potential areas.



Figure N-47. Near-Term Sub-Transmission Capacity for Grid-Scale Resources by Solar Region

It is important to note that these hosting capacity figures are dependent on location. For example, if bid proposals for generation are concentrated in the Kahe area, the hosting capacity is limited to a maximum of 66 MW (depending on location). The maximum 226 MW (sum of regions A-E) assumes ideally placed projects within the designated regions; for example, projects interconnected closer to the substation more capacity tend to have greater capacity than those at the end of a sub-transmission line.

**Near-Term Maui Transmission Constraints**

*An additional 15MW of wind can interconnect to South Maui without triggering a new transmission line (assumes ICEs and load shifting BESS in South Maui).* The South Maui area is served with one 69 kV line looped from Ma’alaea Power Plant through Kealahou area to South Maui and back to Ma’alaea Power Plant. Load flow analyses determined that under normal conditions, the maximum amount of generation that can interconnect in the South Maui area is approximately 56 MW, which is the normal capacity of the 69 kV line. With the existing Auwahi Wind Farm capacity of 21 MW and assuming a proposed new ICE generator of 20 MW (identified to support voltage in the South Maui area), approximately 15 MW of additional wind generation can be added to the South Maui area.

## N. Integrating DG-PV on Our Circuits

Sub-Transmission Integration Methodology, Solutions, and Costs

*An additional 115MW of wind can interconnect to Kaheawa.* There are three 69 kV lines passing thru the Kaheawa wind farm area serving the West Maui load. Load flow analyses determined that during the loss of the Ma'alaea-Lahaina #3 69 kV circuit (N-1 contingency), the maximum amount of generation that can be accommodated in the Kaheawa area is approximately 166 MW based on the 64 MW emergency rating for each of the remaining two lines and a West Maui load of 38 MW during light-load conditions. With the existing Kaheawa wind farm capacity of 51 MW, approximately 115 MW additional generation can be added to the Kaheawa area.

Voltage problems, which require further evaluation, can occur in Central Maui and South Maui as renewable generation replaces generation from Kahului Power Plant and Ma'alaea Power Plant.

### Near-Term Hawai'i Island Transmission Constraints

Up to 70 MW of wind can interconnect in the Lalamilo area. Up to 70 MW of wind interconnect in the Lalamilo area depending upon its interconnection to the system. If directly connected to the Waimea 69 kV substation, 70 MW can be interconnected. Other interconnection options may reduce the wind capacity in the area

Keahole STCC is required for voltage support. Keahole STCC is needed for voltage support when net load is around 130-140 MW and there is no wind output. Under these conditions, the absence of Keahole STCC exposes the West area of the island to voltage collapse when the 7700 line trips.

## Transmission Integration Solutions

The limited sub-transmission capacity will require an expansion of transmission infrastructure on O'ahu for grid-scale resources beyond 2020. As illustrated in Figure N-48, the E3 plans call for significant amounts of grid scale resources.

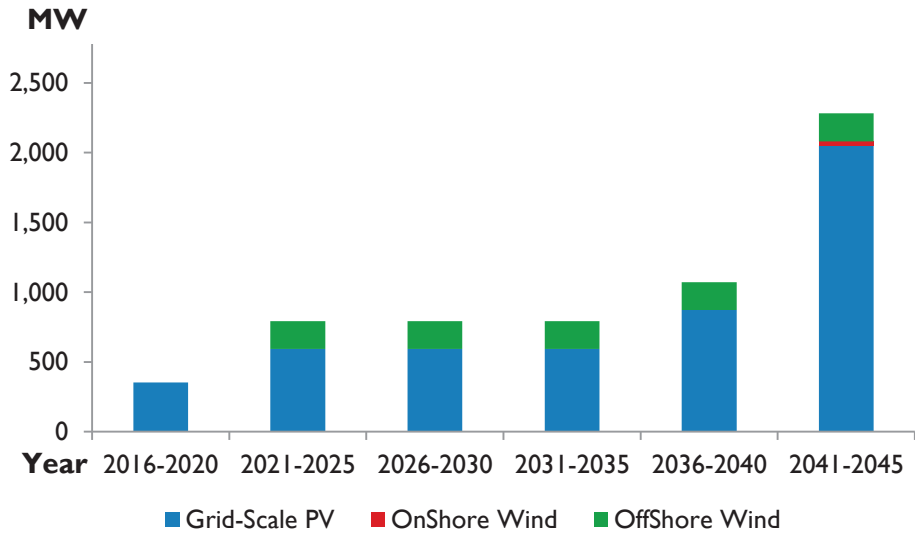

Figure N-48. Cumulative Renewable Grid-Scale Resources; E3 Plans (No LNG)

The O’ahu transmission system does not extend to the far west or north shores of the island. However, the majority of the solar and wind resources on the island are located in these areas. To address capacity constraints, the following figure depicts an approximation of additional transmission infrastructure that would be required.



Figure N-49. Approximate 138 kV Transmission System Expansion to Accommodate Grid-Scale PV in High-Potential Areas

Building additional sub-transmission lines to interconnect grid-scale resources is a feasible alternative; however, may prove costlier. For example, take the Luualualei Area shown in Figure N-49, if 200 MW of grid-scale resources wanted to interconnect in that

## N. Integrating DG-PV on Our Circuits

Sub-Transmission Integration Methodology, Solutions, and Costs

area, it would take four sub-transmission lines (55 MVA capacity each at N-1 reliability) versus two (N-1-1 reliability) transmission lines that can be overbuild on existing sub-transmission pole easements.

### Battery Energy Storage Alternative

Load shifting battery energy storage can partially avoid transmission upgrades; however, cannot fully mitigate transmission expansion if we are to realize the NREL solar potentials on O‘ahu. While batteries distributed throughout the grid can reduce curtailment of as-available generation, relieving thermal capacity overloads (on the sub-transmission system) will require the batteries to be located close to the overload or co-located with the PV facility.

Similar to daytime PV congestion, significant amounts of batteries (2,000 MW) as selected in the E3 plans, co-located with PV systems in the NREL high solar potential areas will encounter sub-transmission capacity issues. Using batteries to avoid thermal overloads means that the batteries must discharge daily to free battery capacity for the next day to store the excess PV generation that would otherwise overload a sub-transmission line.

For example, the dark brown area around the New Lualualei Substation in Figure N-49 has 200 MW of solar potential. Currently, the Kahe-Mikilua sub-transmission line runs through that area. Figure N-50 uses the following assumptions:

- System load profile with DR (Theme 1) on August 19, 2025 scaled downward to the expected proportionate load on the Kahe-Mikilua line.
- 200 MW of grid-scale PV scaled based on the PV profile from the E3 Plan, High DG-PV case without LNG on August 19, 2025.
- 130 MW 4-hour load shifting battery scaled based on the load shifting battery profile from the E3 Plan, High DG-PV case without LNG on August 19, 2025.
- The net load is the difference between the generation and load sources.

**N. Integrating DG-PV on Our Circuits**

Sub-Transmission Integration Methodology, Solutions, and Costs

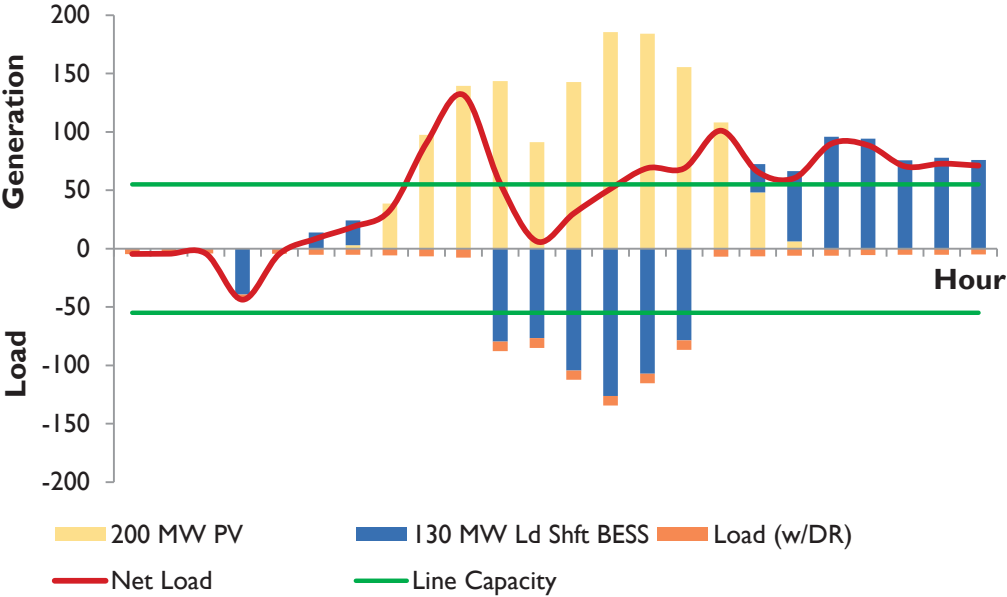

Figure N-50. Sub-Transmission Loading for a 200 MW PV + 130 MW BESS Project

Assuming the sub-transmission line is upgraded to the maximum 55 MVA capacity, Figure N-50 demonstrates that with a battery, capacity overloads can occur during PV and non-PV hours.

Figure N-51 illustrates the same scenario as Figure N-50, with the exception of a 105 MW grid-scale PV plant instead. In this case, the sub-transmission line generally has enough capacity to accommodate the PV output and battery discharge. However, to maximize the solar potential in this area, we would need to build a new sub-transmission or transmission line.

## N. Integrating DG-PV on Our Circuits

Sub-Transmission Integration Methodology, Solutions, and Costs

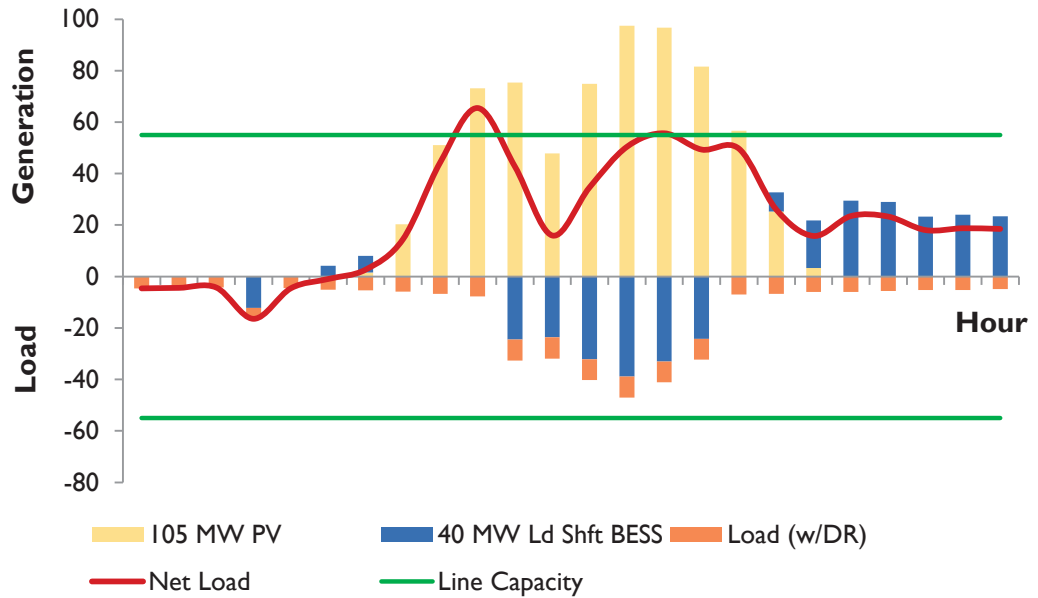

Figure N-51. Sub-Transmission Loading for a 105 MW PV + 40 MW BESS Project

Additional detailed analysis is required to assess other impacts as well as the feasibility and cost-effectiveness of battery storage to avoid transmission upgrades, which will depend on the location and capacity of the resources.

## DG-PV FORECASTS BY DISTRIBUTION CIRCUIT

DG-PV forecasts for all circuits on our three major grid are presented in Table N-15 through Table N-20 for Hawaiian Electric, Maui Electric, and Hawai'i Electric Light circuits.

**Legend:** OCL = Operational Circuit Limit; HC = Posted Hosting Capacity

### Hawaiian Electric Distribution Circuit Market DG-PV Forecast (kW)

Circuit	OCL	HC	2016	2017	2018	2019	2020	2030	2040	2045
Circuit 1	6,044	5,137	1,119	1,372	1,432	1,479	1,522	1,803	2,170	2,170
Circuit 2	5,170	2,392	3,308	4,055	4,233	4,370	4,499	5,287	5,287	5,287
Circuit 3	5,692	484	961	1,178	1,229	1,269	1,307	1,547	1,884	2,085
Circuit 4	361	307	–	–	–	–	–	–	–	–
Circuit 5	4,770	3,284	3,163	3,877	4,047	4,179	4,302	5,094	6,201	6,523
Circuit 6	2,556	2,173	383	470	490	506	521	617	751	831
Circuit 7	1,198	1,019	148	181	189	195	201	217	217	217
Circuit 8	1,940	319	1,020	1,250	1,305	1,348	1,387	1,643	2,000	2,214
Circuit 9	1,301	951	1,041	1,276	1,332	1,375	1,416	1,677	2,041	2,058
Circuit 10	5,107	4,341	2,003	2,456	2,564	2,647	2,725	3,227	3,928	4,348
Circuit 11	689	585	–	–	–	–	–	–	–	–
Circuit 12	1,714	1,457	–	–	–	–	–	–	–	–
Circuit 13	6,272	5,331	154	188	196	203	209	247	301	333
Circuit 14	573	438	635	778	813	839	864	960	960	960
Circuit 15	5,750	4,887	3,480	4,266	4,454	4,598	4,734	5,606	6,824	7,553
Circuit 16	5,701	1,825	2,208	2,706	2,825	2,917	3,003	3,556	4,329	4,791
Circuit 17	5,699	4,605	2,659	3,259	3,402	3,513	3,616	4,282	5,213	5,677
Circuit 18	2,402	2,042	–	–	–	–	–	–	–	–
Circuit 19	3,003	2,553	–	–	–	–	–	–	–	–
Circuit 20	7,330	6,185	529	648	677	699	719	852	1,037	1,148
Circuit 21	5,331	4,499	178	218	228	235	242	287	349	386
Circuit 22	4,733	3,901	–	–	–	–	–	–	–	–
Circuit 23	6,741	5,747	1,055	1,293	1,350	1,393	1,434	1,699	2,068	2,289
Circuit 24	1,448	575	840	1,029	1,074	1,109	1,142	1,352	1,493	1,493
Circuit 25	7,601	4,006	2,933	3,595	3,753	3,875	3,989	4,724	5,750	6,365
Circuit 26	1,005	854	246	302	315	325	335	397	483	534
Circuit 27	771	465	568	696	727	750	772	915	1,113	1,233



## N. Integrating DG-PV on Our Circuits

DG-PV Forecasts by Distribution Circuit

Circuit	OCL	HC	2016	2017	2018	2019	2020	2030	2040	2045
Circuit 28	4,190	3,686	565	693	723	747	769	910	1,108	1,226
Circuit 29	4,187	3,386	3,514	4,308	4,497	4,643	4,780	5,660	6,296	6,296
Circuit 30	6,569	5,583	1,144	1,402	1,464	1,511	1,556	1,842	2,243	2,483
Circuit 31	5,359	4,555	1,151	1,411	1,473	1,520	1,565	1,565	1,565	1,565
Circuit 32	1,211	1,029	457	560	585	604	622	736	833	833
Circuit 33	3,114	1,758	–	–	–	–	–	–	–	–
Circuit 34	3,107	2,641	–	–	–	–	–	–	–	–
Circuit 35	6,611	5,619	2,025	2,482	2,591	2,675	2,754	2,777	2,777	2,777
Circuit 36	4,151	3,635	208	255	266	275	283	335	408	452
Circuit 37	2,806	2,385	–	–	–	–	–	–	–	–
Circuit 38	4,488	3,737	273	334	349	361	371	439	535	592
Circuit 39	1,403	1,193	–	–	–	–	–	–	–	–
Circuit 40	1,873	249	1,865	2,286	2,387	2,464	2,537	2,673	2,673	2,673
Circuit 41	3,266	2,252	312	383	399	412	424	503	612	677
Circuit 42	3,126	2,657	–	–	–	–	–	–	–	–
Circuit 43	4,186	3,558	520	637	665	687	707	838	1,020	1,129
Circuit 44	5,293	1,234	283	347	362	374	385	455	554	614
Circuit 45	5,673	4,822	2,476	2,476	2,476	2,476	2,476	2,476	2,476	2,476
Circuit 46	1,380	1,161	1,074	1,316	1,374	1,419	1,460	1,666	1,666	1,666
Circuit 47	3,559	3,025	–	–	–	–	–	–	–	–
Circuit 48	4,529	3,850	–	–	–	–	–	–	–	–
Circuit 49	3,102	2,637	3,117	3,821	3,989	4,119	4,240	5,021	5,337	5,337
Circuit 50	5,323	4,426	2,909	3,566	3,722	3,843	3,956	4,685	5,703	5,913
Circuit 51	3,931	3,126	1,844	2,260	2,359	2,436	2,508	2,970	3,615	4,001
Circuit 52	4,736	2,867	2,292	2,809	2,932	3,028	3,117	3,691	4,493	4,973
Circuit 53	5,383	6,171	3,342	4,097	4,277	4,416	4,546	5,383	6,553	7,253
Circuit 54	4,830	4,355	3,074	3,768	3,870	3,870	3,870	3,870	3,870	3,870
Circuit 55	6,640	5,120	2,810	2,810	2,810	2,810	2,810	2,810	2,810	2,810
Circuit 56	2,289	1,001	763	935	976	1,007	1,037	1,228	1,495	1,655
Circuit 57	5,837	3,689	748	917	958	989	1,018	1,205	1,467	1,624
Circuit 58	3,014	2,562	4	4	5	5	5	6	7	8
Circuit 59	6,331	3,121	246	301	314	325	334	396	482	533
Circuit 60	3,667	3,117	338	415	433	447	460	545	663	734
Circuit 61	2,895	2,461	190	233	243	251	258	306	373	412
Circuit 62	4,599	4,180	2,446	2,998	3,130	3,231	3,326	3,939	4,795	5,308
Circuit 63	4,789	4,544	2,668	3,271	3,414	3,525	3,629	4,297	5,231	5,581
Circuit 64	4,747	4,445	4,837	5,929	6,021	6,021	6,021	6,021	6,021	6,021
Circuit 65	3,651	3,341	1,534	1,880	1,962	2,026	2,086	2,470	2,534	2,534

## N. Integrating DG-PV on Our Circuits

DG-PV Forecasts by Distribution Circuit

Circuit	OCL	HC	2016	2017	2018	2019	2020	2030	2040	2045
Circuit 66	3,366	2,861	1,786	2,189	2,285	2,359	2,429	2,876	3,498	3,498
Circuit 67	4,703	3,402	2,370	2,370	2,370	2,370	2,370	2,370	2,370	2,370
Circuit 68	4,308	3,662	1,984	2,433	2,539	2,622	2,699	3,196	3,549	3,549
Circuit 69	5,586	4,100	2,163	2,651	2,768	2,858	2,942	3,484	4,241	4,694
Circuit 70	4,351	3,698	1,461	1,791	1,870	1,931	1,987	2,353	2,865	3,171
Circuit 71	8,420	7,157	3,285	4,027	4,204	4,340	4,468	5,291	6,441	7,130
Circuit 72	930	506	8	10	10	11	11	13	16	18
Circuit 73	5,289	4,496	2,955	3,622	3,781	3,904	4,019	4,759	5,793	6,412
Circuit 74	6,899	841	1,018	1,248	1,303	1,345	1,385	1,640	1,996	2,209
Circuit 75	7,393	4,965	160	196	204	211	217	257	313	346
Circuit 76	3,528	2,999	–	–	–	–	–	–	–	–
Circuit 77	2,673	2,594	52	64	66	69	71	84	102	113
Circuit 78	7,301	1,140	3,048	3,737	3,901	4,027	4,146	4,910	5,936	5,936
Circuit 79	1,470	706	1,894	1,894	1,894	1,894	1,894	1,894	1,894	1,894
Circuit 80	5,814	3,867	1,640	2,011	2,099	2,167	2,231	2,642	3,216	3,560
Circuit 81	5,352	3,730	2,687	3,294	3,439	3,551	3,655	4,328	5,269	5,832
Circuit 82	220	445	136	167	174	180	185	220	267	296
Circuit 83	1,968	1,673	904	904	904	904	904	904	904	904
Circuit 84	3,688	3,134	1,863	2,284	2,384	2,462	2,534	3,001	3,305	3,305
Circuit 85	5,288	4,495	1,168	1,431	1,494	1,543	1,588	1,881	2,289	2,534
Circuit 86	6,597	5,607	941	1,153	1,204	1,243	1,280	1,515	1,793	1,793
Circuit 87	5,113	5,647	2,759	3,382	3,530	3,645	3,752	4,443	4,758	4,758
Circuit 88	2,363	1,839	711	711	711	711	711	711	711	711
Circuit 89	2,488	2,419	1,052	1,290	1,347	1,390	1,430	1,430	1,430	1,430
Circuit 90	5,510	4,684	658	806	842	869	895	1,059	1,290	1,380
Circuit 91	1,351	474	593	727	759	784	807	956	1,163	1,288
Circuit 92	3,605	3,064	–	–	–	–	–	–	–	–
Circuit 93	2,416	1,356	1,537	1,884	1,966	2,030	2,090	2,466	2,466	2,466
Circuit 94	4,283	3,640	6	7	8	8	8	10	12	13
Circuit 95	6,936	5,896	3,372	3,372	3,372	3,372	3,372	3,372	3,372	3,372
Circuit 96	7,190	6,112	506	620	647	668	688	815	992	1,098
Circuit 97	7,570	6,435	–	–	–	–	–	–	–	–
Circuit 98	3,979	3,382	291	357	373	385	396	469	566	566
Circuit 99	13,437	10,102	–	–	–	–	–	–	–	–
Circuit 100	4,164	3,539	–	–	–	–	–	–	–	–
Circuit 101	4,381	3,724	3,140	3,849	4,018	4,149	4,271	5,058	6,157	6,527
Circuit 102	4,691	1,374	1,719	2,107	2,200	2,271	2,338	2,769	3,370	3,731
Circuit 103	6,866	5,836	1,490	1,826	1,907	1,969	2,026	2,358	2,358	2,358

## N. Integrating DG-PV on Our Circuits

DG-PV Forecasts by Distribution Circuit

Circuit	OCL	HC	2016	2017	2018	2019	2020	2030	2040	2045
Circuit 104	2,085	1,079	1,324	1,623	1,694	1,749	1,800	2,132	2,596	2,873
Circuit 105	1,609	1,367	891	1,092	1,140	1,178	1,212	1,435	1,559	1,559
Circuit 106	6,462	2,525	1,555	1,906	1,989	2,054	2,114	2,504	3,048	3,374
Circuit 107	1,905	816	1,225	1,502	1,568	1,619	1,667	1,974	2,163	2,163
Circuit 108	5,240	3,794	2,262	2,773	2,894	2,989	3,076	3,643	4,435	4,909
Circuit 109	4,903	1,667	1,747	2,142	2,236	2,309	2,377	2,814	3,426	3,792
Circuit 110	349	296	330	404	422	436	448	531	584	584
Circuit 111	1,287	678	782	958	1,000	1,033	1,063	1,259	1,425	1,425
Circuit 112	3,746	3,184	2,622	3,214	3,355	3,464	3,566	4,079	4,079	4,079
Circuit 113	7,039	5,983	4,665	5,719	5,970	6,164	6,345	7,514	8,062	8,062
Circuit 114	5,755	4,892	3,272	4,011	4,187	4,323	4,450	5,270	6,416	7,101
Circuit 115	1,862	890	1,991	2,440	2,547	2,630	2,707	3,010	3,010	3,010
Circuit 116	1,393	697	905	1,110	1,158	1,196	1,231	1,458	1,775	1,861
Circuit 117	2,519	765	429	526	549	567	583	691	841	931
Circuit 118	430	700	6	8	8	8	9	10	12	14
Circuit 119	2,006	1,399	–	–	–	–	–	–	–	–
Circuit 120	4,969	3,214	320	392	410	423	435	516	628	695
Circuit 121	8,943	6,377	378	463	484	499	514	609	741	820
Circuit 122	2,169	1,102	873	1,070	1,117	1,153	1,187	1,405	1,711	1,847
Circuit 123	2,344	1,992	241	295	308	318	328	388	473	523
Circuit 124	4,831	4,107	–	–	–	–	–	–	–	–
Circuit 125	1,435	1,086	1,671	1,671	1,671	1,671	1,671	1,671	1,671	1,671
Circuit 126	6,644	4,806	–	–	–	–	–	–	–	–
Circuit 127	5,187	4,409	–	–	–	–	–	–	–	–
Circuit 128	1,604	1,364	415	509	532	549	565	669	815	902
Circuit 129	1,681	916	666	816	852	880	905	1,072	1,305	1,445
Circuit 130	1,352	1,086	343	420	439	453	467	552	673	744
Circuit 131	2,267	1,446	748	917	957	988	1,017	1,204	1,466	1,623
Circuit 132	2,449	2,082	518	518	2,018	2,018	3,518	3,518	3,518	3,518
Circuit 133	5,337	4,536	1,058	1,297	1,354	1,398	1,439	1,705	2,075	2,297
Circuit 134	2,267	1,002	911	1,117	1,166	1,204	1,239	1,467	1,786	1,977
Circuit 135	2,752	515	1,026	1,258	1,313	1,356	1,396	1,653	2,012	2,227
Circuit 136	4,602	2,088	600	736	768	793	816	840	840	840
Circuit 137	1,505	1,809	8	10	10	11	11	13	16	17
Circuit 138	5,753	5,889	1,214	1,488	1,554	1,604	1,651	1,956	2,381	2,635
Circuit 139	3,459	2,468	3,029	3,713	3,876	4,002	4,119	4,598	4,598	4,598
Circuit 140	3,856	3,863	773	948	990	1,022	1,052	1,246	1,516	1,679
Circuit 141	2,659	1,905	1,736	2,128	2,221	2,293	2,361	2,796	3,403	3,767

## N. Integrating DG-PV on Our Circuits

DG-PV Forecasts by Distribution Circuit

Circuit	OCL	HC	2016	2017	2018	2019	2020	2030	2040	2045
Circuit 142	2,792	2,539	998	998	998	998	998	998	998	998
Circuit 143	1,889	1,583	1,488	1,488	1,488	1,488	1,488	1,488	1,488	1,488
Circuit 144	8,363	7,109	600	736	768	793	816	966	1,176	1,302
Circuit 145	6,223	5,290	300	368	384	396	408	483	588	651
Circuit 146	6,528	5,549	2,207	2,706	2,825	2,916	3,002	3,555	4,328	4,790
Circuit 147	3,308	2,812	132	162	169	175	180	213	259	287
Circuit 148	2,783	2,366	1,694	2,076	2,167	2,238	2,304	2,728	3,321	3,676
Circuit 149	6,292	5,081	569	697	728	751	773	916	1,115	1,234
Circuit 150	2,983	2,028	272	334	348	360	370	439	470	470
Circuit 151	5,020	4,267	2,519	3,088	3,223	3,328	3,426	4,057	4,618	4,618
Circuit 152	5,741	3,499	587	719	751	775	798	945	1,150	1,273
Circuit 153	4,106	2,067	232	284	296	306	315	373	454	503
Circuit 154	4,941	1,152	–	–	–	–	–	–	–	–
Circuit 155	5,774	4,908	–	–	–	–	–	–	–	–
Circuit 156	4,879	4,147	–	–	–	–	–	–	–	–
Circuit 157	3,629	3,084	87	87	87	87	87	87	87	87
Circuit 158	889	499	316	387	404	417	420	420	420	420
Circuit 159	2,132	984	589	722	754	778	801	949	1,155	1,278
Circuit 160	5,736	4,137	535	656	684	707	728	862	1,049	1,161
Circuit 161	6,310	4,551	1,246	1,527	1,594	1,646	1,694	2,007	2,443	2,704
Circuit 162	4,056	3,448	364	446	465	480	494	585	713	789
Circuit 163	1,911	1,624	206	208	208	208	208	208	208	208
Circuit 164	725	920	629	629	629	629	629	629	629	629
Circuit 165	1,877	1,595	–	–	–	–	–	–	–	–
Circuit 166	1,032	877	398	487	509	525	541	640	670	670
Circuit 167	5,120	4,352	578	709	740	764	786	931	1,133	1,254
Circuit 168	3,546	963	1,226	1,503	1,569	1,620	1,667	1,974	2,404	2,660
Circuit 169	4,029	2,935	3,628	4,447	4,643	4,794	4,935	5,623	5,623	5,623
Circuit 170	1,120	952	409	502	524	541	557	659	803	806
Circuit 171	4,969	3,827	248	304	318	328	338	400	487	539
Circuit 172	2,755	2,342	362	443	463	478	492	582	709	785
Circuit 173	624	531	442	442	442	442	442	442	442	442
Circuit 174	3,230	2,745	928	1,137	1,187	1,226	1,262	1,494	1,537	1,537
Circuit 175	7,927	5,784	692	848	885	914	941	1,114	1,356	1,501
Circuit 176	721	613	–	–	–	–	–	–	–	–
Circuit 177	4,497	3,822	1,617	1,982	2,069	2,136	2,199	2,604	2,747	2,747
Circuit 178	7,024	6,024	1,275	1,562	1,631	1,684	1,734	2,053	2,299	2,299
Circuit 179	3,851	3,052	115	141	147	151	156	185	225	249

## N. Integrating DG-PV on Our Circuits

DG-PV Forecasts by Distribution Circuit

Circuit	OCL	HC	2016	2017	2018	2019	2020	2030	2040	2045
Circuit 180	5,782	4,088	83	102	106	109	113	133	162	180
Circuit 181	83	62	–	–	–	–	–	–	–	–
Circuit 182	3,416	2,510	116	142	148	153	157	186	227	251
Circuit 183	11,185	9,507	500	613	640	661	680	805	980	1,085
Circuit 184	5,907	5,021	270	331	346	357	367	435	529	586
Circuit 185	6,299	5,354	1,945	2,384	2,489	2,570	2,646	3,133	3,557	3,557
Circuit 186	1,088	707	957	1,174	1,225	1,265	1,302	1,542	1,877	2,070
Circuit 187	3,487	2,964	355	435	454	469	483	572	696	771
Circuit 188	6,420	5,641	282	346	361	373	384	455	554	613
Circuit 189	60	52	–	–	–	–	–	–	–	–
Circuit 190	4,546	3,864	–	–	–	–	–	–	–	–
Circuit 191	3,108	2,642	2,350	2,881	3,008	3,105	3,197	3,786	4,009	4,009
Circuit 192	1,030	450	635	778	812	838	863	1,022	1,244	1,377
Circuit 193	3,249	759	–	–	–	–	–	–	–	–
Circuit 194	4,897	4,163	1,897	2,325	2,427	2,506	2,580	2,874	2,874	2,874
Circuit 195	4,138	3,518	1,373	1,373	1,373	1,373	1,373	1,373	1,373	1,373
Circuit 196	7,671	6,520	2,649	3,247	3,389	3,500	3,603	4,266	5,193	5,748
Circuit 197	10,634	9,039	4,440	5,443	5,682	5,867	6,040	7,152	8,053	8,053
Circuit 198	952	809	203	249	260	268	268	268	268	268
Circuit 199	4,410	3,749	1,676	2,054	2,145	2,214	2,280	2,699	3,154	3,154
Circuit 200	4,112	1,608	1,137	1,394	1,455	1,503	1,547	1,832	1,935	1,935
Circuit 201	4,019	3,416	2,551	3,127	3,264	3,370	3,470	4,109	4,697	4,697
Circuit 202	4,355	2,666	1,694	2,077	2,168	2,238	2,304	2,433	2,433	2,433
Circuit 203	505	430	87	107	111	115	118	140	144	144
Circuit 204	5,370	4,565	39	47	49	51	52	62	76	84
Circuit 205	983	835	–	–	–	–	–	–	–	–
Circuit 206	3,562	3,027	–	–	–	–	–	–	–	–
Circuit 207	4,274	3,083	58	71	74	76	78	93	113	125
Circuit 208	3,627	1,295	836	1,024	1,069	1,104	1,136	1,346	1,638	1,813
Circuit 209	1,711	1,454	545	668	697	720	741	878	1,069	1,118
Circuit 210	3,125	2,693	1,537	1,884	1,967	2,031	2,090	2,475	3,013	3,336
Circuit 211	6,616	5,808	3,213	3,938	4,111	4,245	4,370	5,175	6,300	6,973
Circuit 212	5,706	5,033	2,562	3,141	3,279	3,386	3,485	4,127	5,024	5,561
Circuit 213	1,903	1,471	1,139	1,396	1,457	1,505	1,549	1,834	2,233	2,471
Circuit 214	8,176	6,950	350	429	448	462	476	564	686	760
Circuit 215	5,354	3,717	1,590	1,949	2,035	2,101	2,163	2,561	2,780	2,780
Circuit 216	2,008	1,706	609	609	609	609	609	609	609	609
Circuit 217	5,447	4,630	1,120	1,373	1,433	1,480	1,523	1,804	2,196	2,431

## N. Integrating DG-PV on Our Circuits

DG-PV Forecasts by Distribution Circuit

Circuit	OCL	HC	2016	2017	2018	2019	2020	2030	2040	2045
Circuit 218	3,541	3,010	1,371	1,681	1,754	1,811	1,865	2,208	2,688	2,975
Circuit 219	179	152	–	–	–	–	–	–	–	–
Circuit 220	2,869	2,438	1,993	2,444	2,551	2,634	2,711	3,211	3,908	4,326
Circuit 221	6,009	4,641	1,722	2,111	2,204	2,276	2,343	2,774	3,377	3,738
Circuit 222	2,079	1,767	1,602	1,964	2,050	2,117	2,179	2,580	3,141	3,338
Circuit 223	5,005	2,998	907	1,112	1,160	1,198	1,233	1,461	1,778	1,968
Circuit 224	2,919	2,127	350	429	448	462	476	564	686	760
Circuit 225	8,145	6,776	863	1,058	1,105	1,141	1,174	1,391	1,693	1,874
Circuit 226	1,186	578	322	395	413	426	432	432	432	432
Circuit 227	190	162	35	42	44	46	47	56	68	75
Circuit 228	2,419	676	917	1,124	1,173	1,211	1,247	1,477	1,797	1,990
Circuit 229	7,351	6,249	2,573	3,154	3,293	3,400	3,500	4,144	5,045	5,550
Circuit 230	4,579	3,892	1,027	1,259	1,315	1,357	1,397	1,655	2,014	2,230
Circuit 231	2,090	1,777	599	735	767	792	815	965	1,175	1,301
Circuit 232	4,899	4,237	96	118	123	127	131	155	188	208
Circuit 233	7,858	4,263	2,930	3,591	3,749	3,871	3,985	4,719	5,744	6,358
Circuit 234	1,663	1,532	294	361	377	389	400	474	577	639
Circuit 235	5,011	4,027	2,338	2,866	2,916	2,916	2,916	2,916	2,916	2,916
Circuit 236	8,704	4,964	3,984	4,884	5,098	5,264	5,419	6,417	7,193	7,193
Circuit 237	4,312	4,027	2,592	3,177	3,316	3,424	3,525	4,174	5,081	5,615
Circuit 238	748	717	958	958	958	958	958	958	958	958
Circuit 239	3,566	3,031	1,897	2,326	2,428	2,507	2,580	3,056	3,720	4,118
Circuit 240	4,602	4,036	2	3	3	3	3	4	5	5
Circuit 241	8,243	6,839	2,600	2,833	2,833	2,833	2,833	2,833	2,833	2,833
Circuit 242	1,597	1,256	365	447	467	482	496	588	715	792
Circuit 243	177	2,344	–	–	–	–	–	–	–	–
Circuit 244	2,979	3,794	679	832	868	897	923	1,093	1,330	1,473
Circuit 245	5,261	3,543	2,168	2,658	2,775	2,865	2,949	3,492	4,251	4,387
Circuit 246	711	226	–	–	–	–	–	–	–	–
Circuit 247	4,259	3,857	438	537	560	578	596	705	858	950
Circuit 248	4,452	793	1,099	1,347	1,406	1,452	1,494	1,770	1,945	1,945
Circuit 249	3,632	432	228	280	292	302	310	368	448	495
Circuit 250	2,345	1,993	1,140	1,397	1,459	1,506	1,550	1,836	2,166	2,166
Circuit 251	8,975	5,107	8,105	9,935	10,372	10,709	11,024	12,473	12,473	12,473
Circuit 252	2,897	963	1,507	1,847	1,928	1,990	2,049	2,426	2,664	2,664
Circuit 253	108	92	–	–	–	–	–	–	–	–
Circuit 254	7,195	6,288	585	717	748	773	795	942	1,147	1,269
Circuit 255	5,548	5,328	536	657	686	709	729	864	1,052	1,164

## N. Integrating DG-PV on Our Circuits

DG-PV Forecasts by Distribution Circuit

Circuit	OCL	HC	2016	2017	2018	2019	2020	2030	2040	2045
Circuit 256	3,836	3,624	726	890	930	960	988	1,170	1,424	1,576
Circuit 257	5,354	5,059	1,474	1,807	1,886	1,947	2,005	2,374	2,890	3,199
Circuit 258	5,212	2,335	4,705	5,768	6,021	6,217	6,400	7,579	9,226	10,212
Circuit 259	3,216	2,781	6,168	7,561	7,893	8,150	8,390	8,838	8,838	8,838
Circuit 260	8,148	5,689	4,628	5,673	5,922	6,115	6,294	7,454	9,074	10,044
Circuit 261	4,605	3,914	2,195	2,691	2,809	2,901	2,986	3,536	4,304	4,636
Circuit 262	5,475	4,654	1,483	1,818	1,898	1,960	2,017	2,389	2,812	2,812
Circuit 263	3,763	3,199	2,552	2,552	2,552	2,552	2,552	2,552	2,552	2,552
Circuit 264	5,762	4,898	4,075	4,173	4,173	4,173	4,173	4,173	4,173	4,173
Circuit 265	5,107	3,907	762	934	975	1,007	1,036	1,227	1,494	1,653
Circuit 266	3,937	3,346	182	223	233	240	247	293	357	395
Circuit 267	2,933	2,493	471	578	603	623	641	650	650	650
Circuit 268	6,033	5,128	1,623	1,989	2,077	2,144	2,207	2,614	3,182	3,522
Circuit 269	4,641	3,945	–	–	–	–	–	–	–	–
Circuit 270	4,421	3,758	1,116	1,368	1,428	1,474	1,518	1,797	2,009	2,009
Circuit 271	4,171	3,545	2,511	3,078	3,213	3,317	3,415	4,044	4,577	4,577
Circuit 272	1,154	981	495	607	633	654	673	797	970	1,074
Circuit 273	2,143	1,822	457	561	585	604	622	737	897	973
Circuit 274	2,946	2,504	1,520	1,864	1,946	2,009	2,068	2,449	2,925	2,925
Circuit 275	7,570	5,984	3,619	4,437	4,632	4,782	4,923	4,931	4,931	4,931
Circuit 276	3,122	3,475	4,129	4,129	4,129	4,129	4,129	4,129	4,129	4,129
Circuit 277	4,614	4,103	2,334	2,862	2,987	3,084	3,175	3,760	4,577	5,067
Circuit 278	4,340	3,953	2,186	2,680	2,798	2,888	2,973	3,521	4,286	4,690
Circuit 279	1,177	1,057	986	1,208	1,261	1,302	1,341	1,588	1,933	2,139
Circuit 280	2,936	2,495	897	1,099	1,147	1,185	1,220	1,444	1,758	1,946
Circuit 281	1,316	772	1,169	1,433	1,496	1,545	1,590	1,883	2,032	2,032
Circuit 282	4,214	780	1,137	1,394	1,455	1,502	1,546	1,831	2,229	2,468
Circuit 283	3,839	2,871	1,028	1,260	1,315	1,358	1,398	1,656	2,015	2,231
Circuit 284	2,299	1,954	1,798	2,204	2,300	2,375	2,445	2,895	3,520	3,520
Circuit 285	5,662	1,636	2,961	3,630	3,789	3,912	4,027	4,769	5,806	6,427
Circuit 286	5,271	4,480	33	41	43	44	45	54	66	73
Circuit 287	3,252	2,048	1,978	2,425	2,531	2,614	2,691	3,186	3,399	3,399
Circuit 288	9,600	3,270	3,026	3,709	3,872	3,998	4,115	4,874	5,338	5,338
Circuit 289	2,667	3,617	265	325	339	350	360	427	520	575
Circuit 290	2,772	1,028	1,170	1,434	1,497	1,546	1,592	1,885	2,294	2,540
Circuit 291	4,820	3,749	968	1,187	1,239	1,280	1,317	1,560	1,899	2,102
Circuit 292	5,222	2,086	970	1,189	1,242	1,282	1,320	1,563	1,903	2,106
Circuit 293	5,768	4,903	1,383	1,695	1,769	1,827	1,881	2,227	2,711	3,001

## N. Integrating DG-PV on Our Circuits

DG-PV Forecasts by Distribution Circuit

Circuit	OCL	HC	2016	2017	2018	2019	2020	2030	2040	2045
Circuit 294	6,307	3,281	767	940	981	1,013	1,043	1,235	1,503	1,664
Circuit 295	4,017	3,617	328	403	420	434	447	529	644	713
Circuit 296	4,136	2,357	412	505	527	545	561	664	808	895
Circuit 297	3,545	1,694	1,575	1,931	2,015	2,081	2,142	2,537	2,795	2,795
Circuit 298	4,054	3,446	2,444	2,996	3,128	3,230	3,325	3,937	4,507	4,507
Circuit 299	6,304	3,496	844	1,035	1,080	1,115	1,148	1,360	1,655	1,832
Circuit 300	4,455	1,469	1,791	2,195	2,292	2,366	2,436	2,885	3,512	3,887
Circuit 301	1,053	496	484	593	619	639	658	779	948	1,050
Circuit 302	4,019	3,416	1,763	2,161	2,256	2,329	2,397	2,839	3,456	3,825
Circuit 303	6,695	3,596	4,674	5,729	5,981	6,175	6,357	7,528	9,164	9,263
Circuit 304	2,526	2,147	1,365	1,673	1,747	1,798	1,798	1,798	1,798	1,798
Circuit 305	1,852	740	964	1,182	1,234	1,274	1,312	1,553	1,891	2,093
Circuit 306	2,635	1,809	68	83	87	90	92	109	133	147
Circuit 307	4,943	4,202	2,091	2,563	2,676	2,763	2,844	3,368	4,100	4,337
Circuit 308	1,236	1,051	1,080	1,324	1,382	1,427	1,469	1,574	1,574	1,574
Circuit 309	1,140	714	469	575	600	620	638	755	920	928
Circuit 310	6,808	5,787	465	569	594	614	632	748	911	1,008
Circuit 311	6,285	5,342	460	564	589	608	626	741	902	998
Circuit 312	3,034	2,579	–	–	–	–	–	–	–	–
Circuit 313	3,923	2,934	1,799	2,206	2,303	2,377	2,447	2,898	3,484	3,484
Circuit 314	5,183	4,405	1,612	1,976	2,063	2,130	2,192	2,353	2,353	2,353
Circuit 315	3,086	2,623	489	599	626	646	665	788	959	1,061
Circuit 316	1,536	1,305	265	325	339	350	361	427	520	575
Circuit 317	5,006	3,868	48	59	62	64	65	78	94	104
Circuit 318	5,261	3,540	216	265	276	285	294	348	424	469
Circuit 319	4,865	4,135	349	428	447	462	475	563	685	758
Circuit 320	5,762	2,253	2,266	2,778	2,900	2,994	3,082	3,650	4,010	4,010
Circuit 321	337	287	79	96	101	104	107	127	154	171
Circuit 322	4,669	4,724	747	916	956	987	1,016	1,204	1,465	1,620
Circuit 323	144	123	–	–	–	–	–	–	–	–
Circuit 324	5,894	5,010	2,371	2,371	2,371	2,371	2,371	2,371	2,371	2,371
Circuit 325	608	588	501	615	642	662	682	808	983	1,081
Circuit 326	1,410	762	858	1,052	1,098	1,133	1,167	1,382	1,682	1,862
Circuit 327	1,463	511	1,311	1,311	1,311	1,311	1,311	1,311	1,311	1,311
Circuit 328	6,119	5,201	3,099	3,799	3,966	4,095	4,216	4,992	5,819	5,819
Circuit 329	1,610	1,369	1,053	1,290	1,347	1,391	1,432	1,695	2,055	2,055
Circuit 330	5,881	4,999	3,528	4,325	4,515	4,661	4,798	5,127	5,127	5,127
Circuit 331	924	785	95	116	121	125	129	152	186	205



## N. Integrating DG-PV on Our Circuits

DG-PV Forecasts by Distribution Circuit

Circuit	OCL	HC	2016	2017	2018	2019	2020	2030	2040	2045
Circuit 332	7,351	3,171	3,679	4,510	4,708	4,861	5,004	5,926	7,214	7,985
Circuit 333	5,964	5,069	1,020	1,250	1,305	1,347	1,387	1,642	1,999	2,213
Circuit 334	2,507	2,131	479	587	613	633	652	772	940	1,040
Circuit 335	3,598	3,058	1,369	1,369	1,369	1,369	1,369	1,369	1,369	1,369
Circuit 336	5,827	4,953	2,046	2,508	2,619	2,704	2,783	2,945	2,945	2,945
Circuit 337	3,697	3,143	1,061	1,301	1,358	1,402	1,444	1,710	2,081	2,304
Circuit 338	959	815	204	204	204	204	204	204	204	204
Circuit 339	9,020	7,667	2,362	2,647	2,647	2,647	2,647	2,647	2,647	2,647
Circuit 340	3,646	3,099	1,452	1,780	1,858	1,918	1,974	2,338	2,846	3,151
Circuit 341	746	634	–	–	–	–	–	–	–	–
Circuit 342	4,140	1,454	1,864	2,286	2,386	2,463	2,536	3,003	3,656	4,046
Circuit 343	5,806	4,935	2,484	3,045	3,178	3,282	3,378	4,001	4,326	4,326
Circuit 344	4,257	3,619	1,738	2,131	2,225	2,297	2,364	2,367	2,367	2,367
Circuit 345	9,447	6,464	738	905	944	975	1,004	1,189	1,447	1,602
Circuit 346	4,257	3,619	1,580	1,937	2,022	2,088	2,150	2,546	3,099	3,251
Circuit 347	6,038	3,233	2,664	3,266	3,409	3,520	3,623	4,291	5,223	5,700
Circuit 348	3,111	1,014	1,179	1,446	1,509	1,558	1,604	1,899	2,312	2,559
Circuit 349	419	356	473	580	605	625	643	761	927	1,026
Circuit 350	6,149	3,240	2,547	3,123	3,260	3,366	3,465	4,103	4,995	5,529
Circuit 351	3,133	2,663	–	–	–	–	–	–	–	–
Circuit 352	2,391	1,567	44	44	44	44	44	44	44	44
Circuit 353	7,969	5,222	–	–	–	–	–	–	–	–
Circuit 354	6,602	5,612	24	29	31	32	33	39	47	52
Circuit 355	6,104	5,188	121	149	155	160	165	195	238	263
Circuit 356	3,888	3,304	46	56	59	61	63	74	90	100
Circuit 357	4,256	3,618	–	–	–	–	–	–	–	–
Circuit 358	2,982	2,535	1,070	1,312	1,369	1,414	1,455	1,724	2,098	2,322
Circuit 359	6,054	949	3,858	4,730	4,937	5,098	5,248	6,214	7,565	8,374
Circuit 360	1,341	513	595	595	595	595	595	595	595	595
Circuit 361	277	122	151	151	151	151	151	151	151	151
Circuit 362	6,306	5,364	1,308	1,604	1,674	1,729	1,780	2,107	2,565	2,840
Circuit 363	4,376	3,725	1,679	2,053	2,053	2,053	2,053	2,053	2,053	2,053
Circuit 364	5,368	4,562	3,881	4,757	4,966	5,127	5,278	6,185	6,185	6,185
Circuit 365	4,712	2,283	1,561	1,914	1,998	2,063	2,124	2,515	3,061	3,388
Circuit 366	4,162	1,910	1,120	1,373	1,434	1,480	1,524	1,805	2,197	2,432
Circuit 367	2,068	1,758	1,173	1,438	1,501	1,550	1,595	1,889	2,299	2,545
Circuit 368	4,623	1,336	1,540	1,887	1,970	2,034	2,094	2,480	3,019	3,342
Circuit 369	5,678	4,380	2,925	3,585	3,743	3,864	3,978	4,711	5,734	6,347

## N. Integrating DG-PV on Our Circuits

DG-PV Forecasts by Distribution Circuit

Circuit	OCL	HC	2016	2017	2018	2019	2020	2030	2040	2045
Circuit 370	3,020	524	526	645	674	695	716	848	1,032	1,142
Circuit 371	4,080	913	2,136	2,618	2,733	2,822	2,905	3,440	4,188	4,635
Circuit 372	5,743	4,882	3,688	4,521	4,720	4,873	5,016	5,940	7,138	7,138
Circuit 373	7,141	5,038	4,995	6,123	6,392	6,600	6,794	8,045	8,421	8,421
Circuit 374	4,249	3,612	1,302	1,596	1,666	1,720	1,770	2,096	2,233	2,233
Circuit 375	4,040	3,434	754	924	965	996	1,026	1,215	1,479	1,623
Circuit 376	1,431	1,216	847	1,039	1,084	1,120	1,153	1,208	1,208	1,208
Circuit 377	1,821	717	1,084	1,328	1,387	1,432	1,474	1,745	2,124	2,222
Circuit 378	308	262	37	37	37	37	37	37	37	37
Circuit 379	3,073	2,069	1,454	1,782	1,860	1,921	1,977	2,341	2,850	3,155
Circuit 380	1,552	1,319	1,666	2,042	2,131	2,201	2,265	2,683	2,699	2,699
Circuit 381	1,106	640	907	1,112	1,161	1,199	1,234	1,461	1,779	1,969
Circuit 382	–	–	40,100	49,157	51,315	52,983	54,542	64,588	78,625	87,030

Table N-15. Distribution Circuit Market DG-PV Forecast: Hawaiian Electric (kW)

## N. Integrating DG-PV on Our Circuits

DG-PV Forecasts by Distribution Circuit

### Hawaiian Electric Distribution Circuit High DG-PV Forecast (kW)

Circuit	OCL	HC	2016	2017	2018	2019	2020	2030	2040	2045
Circuit 1	6,044	5,137	1,119	1,282	1,402	1,453	1,506	2,547	3,634	3,634
Circuit 2	5,170	2,392	3,308	3,789	4,143	4,294	4,450	6,752	6,752	6,752
Circuit 3	5,692	484	961	1,101	1,203	1,247	1,293	2,186	3,127	3,598
Circuit 4	361	307	–	–	–	–	–	–	–	–
Circuit 5	4,770	3,284	3,163	3,623	3,961	4,106	4,255	7,196	7,987	7,987
Circuit 6	2,556	2,173	383	439	480	497	515	871	1,247	1,434
Circuit 7	1,198	1,019	148	169	185	192	199	336	481	553
Circuit 8	1,940	319	1,020	1,168	1,277	1,324	1,372	2,320	3,320	3,819
Circuit 9	1,301	951	1,041	1,193	1,304	1,352	1,401	2,369	3,389	3,523
Circuit 10	5,107	4,341	2,003	2,295	2,509	2,601	2,695	4,558	6,521	7,502
Circuit 11	689	585	–	–	–	–	–	–	–	–
Circuit 12	1,714	1,457	–	–	–	–	–	–	–	–
Circuit 13	6,272	5,331	154	176	192	199	207	349	500	575
Circuit 14	573	438	635	727	795	825	854	1,445	2,067	2,378
Circuit 15	5,750	4,887	3,480	3,987	4,359	4,519	4,683	7,918	11,328	13,033
Circuit 16	5,701	1,825	2,208	2,529	2,765	2,866	2,970	5,023	7,186	7,297
Circuit 17	5,699	4,605	2,659	3,045	3,330	3,452	3,577	6,049	7,141	7,141
Circuit 18	2,402	2,042	–	–	–	–	–	–	–	–
Circuit 19	3,003	2,553	–	–	–	–	–	–	–	–
Circuit 20	7,330	6,185	529	606	662	687	712	1,203	1,721	1,981
Circuit 21	5,331	4,499	178	204	223	231	239	405	579	667
Circuit 22	4,733	3,901	–	–	–	–	–	–	–	–
Circuit 23	6,741	5,747	1,055	1,208	1,321	1,369	1,419	2,399	3,433	3,950
Circuit 24	1,448	575	840	962	1,051	1,090	1,130	1,910	2,733	2,957
Circuit 25	7,601	4,006	2,933	3,359	3,673	3,808	3,946	6,672	8,143	8,143
Circuit 26	1,005	854	246	282	308	320	331	560	801	922
Circuit 27	771	465	568	651	711	737	764	1,292	1,849	2,127
Circuit 28	4,190	3,686	565	647	708	734	760	1,286	1,839	1,874
Circuit 29	4,187	3,386	3,514	4,026	4,402	4,563	4,728	7,760	7,760	7,760
Circuit 30	6,569	5,583	1,144	1,310	1,433	1,485	1,539	2,603	3,723	4,284
Circuit 31	5,359	4,555	1,151	1,318	1,441	1,494	1,548	2,618	3,029	3,029
Circuit 32	1,211	1,029	457	524	573	594	615	1,040	1,488	1,712
Circuit 33	3,114	1,758	–	–	–	–	–	–	–	–
Circuit 34	3,107	2,641	–	–	–	–	–	–	–	–
Circuit 35	6,611	5,619	2,025	2,319	2,536	2,629	2,724	4,006	4,006	4,006
Circuit 36	4,151	3,635	208	239	261	270	280	474	678	780

## N. Integrating DG-PV on Our Circuits

DG-PV Forecasts by Distribution Circuit

Circuit	OCL	HC	2016	2017	2018	2019	2020	2030	2040	2045
Circuit 37	2,806	2,385	–	–	–	–	–	–	–	–
Circuit 38	4,488	3,737	273	313	342	354	367	621	888	1,022
Circuit 39	1,403	1,193	–	–	–	–	–	–	–	–
Circuit 40	1,873	249	1,865	2,137	2,336	2,422	2,510	4,137	4,137	4,137
Circuit 41	3,266	2,252	312	357	391	405	420	710	1,016	1,169
Circuit 42	3,126	2,657	–	–	–	–	–	–	–	–
Circuit 43	4,186	3,558	520	596	651	675	700	1,183	1,410	1,410
Circuit 44	5,293	1,234	283	324	354	367	380	643	920	1,059
Circuit 45	5,673	4,822	2,476	2,476	2,476	2,476	2,476	2,476	2,476	2,476
Circuit 46	1,380	1,161	1,074	1,230	1,345	1,394	1,445	2,443	3,130	3,130
Circuit 47	3,559	3,025	–	–	–	–	–	–	–	–
Circuit 48	4,529	3,850	–	–	–	–	–	–	–	–
Circuit 49	3,102	2,637	3,117	3,571	3,905	4,047	4,194	6,801	6,801	6,801
Circuit 50	5,323	4,426	2,909	3,332	3,643	3,777	3,914	6,618	7,377	7,377
Circuit 51	3,931	3,126	1,844	2,112	2,309	2,394	2,481	4,195	6,001	6,904
Circuit 52	4,736	2,867	2,292	2,625	2,870	2,975	3,083	5,214	7,459	7,938
Circuit 53	5,383	6,171	3,342	3,828	4,186	4,339	4,497	7,604	9,635	9,635
Circuit 54	4,830	4,355	3,074	3,521	3,850	3,991	4,135	5,335	5,335	5,335
Circuit 55	6,640	5,120	2,810	2,810	2,810	2,810	2,810	2,810	2,810	2,810
Circuit 56	2,289	1,001	763	873	955	990	1,026	1,735	2,482	2,856
Circuit 57	5,837	3,689	748	857	937	972	1,007	1,703	2,436	2,451
Circuit 58	3,014	2,562	4	4	5	5	5	8	12	14
Circuit 59	6,331	3,121	246	281	308	319	331	559	564	564
Circuit 60	3,667	3,117	338	387	424	439	455	769	1,101	1,267
Circuit 61	2,895	2,461	190	218	238	247	256	432	618	712
Circuit 62	4,599	4,180	2,446	2,446	2,446	2,446	2,446	2,446	2,446	2,446
Circuit 63	4,789	4,544	2,668	3,056	3,342	3,464	3,590	6,070	7,046	7,046
Circuit 64	4,747	4,445	4,837	5,541	6,058	6,280	6,508	7,472	7,472	7,472
Circuit 65	3,651	3,341	1,534	1,757	1,921	1,991	2,063	3,489	3,999	3,999
Circuit 66	3,366	2,861	1,786	2,046	2,237	2,318	2,403	4,063	4,962	4,962
Circuit 67	4,703	3,402	2,370	2,715	2,969	3,077	3,189	3,347	3,347	3,347
Circuit 68	4,308	3,662	1,984	2,273	2,485	2,576	2,670	4,515	4,895	4,895
Circuit 69	5,586	4,100	2,163	2,478	2,709	2,808	2,910	4,921	7,040	7,348
Circuit 70	4,351	3,698	1,461	1,674	1,830	1,897	1,966	3,324	4,756	5,472
Circuit 71	8,420	7,157	3,285	3,763	4,115	4,265	4,420	7,474	10,693	12,302
Circuit 72	930	506	8	9	10	11	11	19	27	31
Circuit 73	5,289	4,496	2,955	3,384	3,701	3,836	3,975	6,722	8,100	8,100
Circuit 74	6,899	841	1,018	1,166	1,275	1,322	1,370	2,316	3,313	3,812

## N. Integrating DG-PV on Our Circuits

DG-PV Forecasts by Distribution Circuit

Circuit	OCL	HC	2016	2017	2018	2019	2020	2030	2040	2045
Circuit 75	7,393	4,965	160	183	200	207	215	363	519	597
Circuit 76	3,528	2,999	–	–	–	–	–	–	–	–
Circuit 77	2,673	2,594	52	60	65	67	70	118	169	195
Circuit 78	7,301	1,140	3,048	3,492	3,818	3,958	4,101	6,935	7,400	7,400
Circuit 79	1,470	706	1,894	2,170	2,372	2,459	2,548	3,241	3,241	3,241
Circuit 80	5,814	3,867	1,640	1,640	1,640	1,640	1,640	1,640	1,640	1,640
Circuit 81	5,352	3,730	2,687	3,078	3,366	3,489	3,616	6,114	8,182	8,182
Circuit 82	220	445	136	156	171	177	183	310	444	510
Circuit 83	1,968	1,673	904	1,036	1,132	1,174	1,216	2,057	2,060	2,060
Circuit 84	3,688	3,134	1,863	2,134	2,334	2,419	2,507	4,239	4,769	4,769
Circuit 85	5,288	4,495	1,168	1,338	1,463	1,516	1,571	2,657	3,801	4,041
Circuit 86	6,597	5,607	941	1,078	1,178	1,222	1,266	1,793	1,793	1,793
Circuit 87	5,113	5,647	2,759	3,160	3,455	3,582	3,712	6,223	6,223	6,223
Circuit 88	2,363	1,839	711	815	891	924	957	1,619	2,060	2,060
Circuit 89	2,488	2,419	1,052	1,205	1,318	1,366	1,416	2,394	2,895	2,895
Circuit 90	5,510	4,684	658	753	824	854	885	1,496	2,141	2,463
Circuit 91	1,351	474	593	680	743	770	798	1,350	1,932	2,222
Circuit 92	3,605	3,064	–	–	–	–	–	–	–	–
Circuit 93	2,416	1,356	1,537	1,760	1,925	1,995	2,068	3,496	3,706	3,706
Circuit 94	4,283	3,640	6	7	8	8	8	14	20	22
Circuit 95	6,936	5,896	3,372	3,372	3,372	3,372	3,372	3,372	3,372	3,372
Circuit 96	7,190	6,112	506	579	634	657	681	1,151	1,647	1,894
Circuit 97	7,570	6,435	–	–	–	–	–	–	–	–
Circuit 98	3,979	3,382	291	334	365	378	392	566	566	566
Circuit 99	13,437	10,102	–	–	–	–	–	–	–	–
Circuit 100	4,164	3,539	–	–	–	–	–	–	–	–
Circuit 101	4,381	3,724	3,140	3,597	3,933	4,077	4,225	7,144	7,992	7,992
Circuit 102	4,691	1,374	1,719	1,719	1,719	1,719	1,719	1,719	1,719	1,719
Circuit 103	6,866	5,836	1,490	1,707	1,866	1,934	2,005	3,390	3,772	3,772
Circuit 104	2,085	1,079	1,324	1,516	1,658	1,719	1,781	3,012	4,309	4,957
Circuit 105	1,609	1,367	891	1,021	1,116	1,157	1,199	2,028	2,901	3,023
Circuit 106	6,462	2,525	1,555	1,781	1,947	2,018	2,092	3,537	5,060	5,411
Circuit 107	1,905	816	1,225	1,404	1,535	1,591	1,649	2,788	3,628	3,628
Circuit 108	5,240	3,794	2,262	2,591	2,833	2,937	3,043	5,146	7,362	7,598
Circuit 109	4,903	1,667	1,747	2,002	2,188	2,269	2,351	3,975	5,687	6,202
Circuit 110	349	296	330	378	413	428	443	750	1,073	1,234
Circuit 111	1,287	678	782	895	979	1,015	1,052	1,779	2,545	2,889
Circuit 112	3,746	3,184	2,622	3,004	3,284	3,404	3,528	5,543	5,543	5,543

## N. Integrating DG-PV on Our Circuits

DG-PV Forecasts by Distribution Circuit

Circuit	OCL	HC	2016	2017	2018	2019	2020	2030	2040	2045
Circuit 113	7,039	5,983	4,665	5,344	5,843	6,057	6,277	9,526	9,526	9,526
Circuit 114	5,755	4,892	3,272	3,748	4,098	4,248	4,403	7,444	9,977	9,977
Circuit 115	1,862	890	1,991	2,280	2,493	2,584	2,678	4,474	4,474	4,474
Circuit 116	1,393	697	905	1,037	1,134	1,175	1,218	2,059	2,946	3,325
Circuit 117	2,519	765	429	491	537	557	577	976	1,396	1,606
Circuit 118	430	700	6	7	8	8	9	14	21	24
Circuit 119	2,006	1,399	–	–	–	–	–	–	–	–
Circuit 120	4,969	3,214	320	367	401	416	431	728	1,042	1,199
Circuit 121	8,943	6,377	378	433	473	491	508	860	958	958
Circuit 122	2,169	1,102	873	1,000	1,093	1,133	1,174	1,985	2,840	3,268
Circuit 123	2,344	1,992	241	276	302	313	324	548	784	903
Circuit 124	4,831	4,107	–	–	–	–	–	–	–	–
Circuit 125	1,435	1,086	1,671	1,914	2,093	2,170	2,248	2,895	2,895	2,895
Circuit 126	6,644	4,806	–	–	–	–	–	–	–	–
Circuit 127	5,187	4,409	–	–	–	–	–	–	–	–
Circuit 128	1,604	1,364	415	476	520	539	559	945	1,352	1,556
Circuit 129	1,681	916	666	763	834	864	896	1,515	2,167	2,493
Circuit 130	1,352	1,086	343	393	430	445	462	780	1,116	1,285
Circuit 131	2,267	1,446	748	857	937	971	1,006	1,701	2,434	2,800
Circuit 132	2,449	2,082	518	593	649	673	697	1,179	1,464	1,464
Circuit 133	5,337	4,536	1,058	1,212	1,326	1,374	1,424	2,408	3,445	3,508
Circuit 134	2,267	1,002	911	1,044	1,141	1,183	1,226	2,073	2,966	3,412
Circuit 135	2,752	515	1,026	1,176	1,285	1,332	1,381	2,335	3,341	3,843
Circuit 136	4,602	2,088	600	687	752	779	807	–	–	–
Circuit 137	1,505	1,809	8	9	10	10	11	18	26	30
Circuit 138	5,753	5,889	1,214	1,391	1,521	1,576	1,634	2,762	3,682	3,682
Circuit 139	3,459	2,468	3,029	3,469	3,793	3,932	4,075	6,063	6,063	6,063
Circuit 140	3,856	3,863	773	886	969	1,004	1,041	1,760	2,517	2,896
Circuit 141	2,659	1,905	1,736	1,988	2,174	2,253	2,335	3,949	5,649	6,500
Circuit 142	2,792	2,539	998	1,143	1,250	1,296	1,343	1,467	1,467	1,467
Circuit 143	1,889	1,583	1,488	1,705	1,733	1,733	1,733	1,733	1,733	1,733
Circuit 144	8,363	7,109	600	687	752	779	807	1,365	1,953	2,247
Circuit 145	6,223	5,290	300	344	376	390	404	683	976	1,123
Circuit 146	6,528	5,549	2,207	2,528	2,765	2,866	2,970	5,022	6,797	6,797
Circuit 147	3,308	2,812	132	151	166	172	178	301	430	495
Circuit 148	2,783	2,366	1,694	1,940	2,121	2,199	2,279	3,854	5,513	5,727
Circuit 149	6,292	5,081	569	651	712	738	765	1,294	1,851	2,129
Circuit 150	2,983	2,028	272	312	341	354	366	470	470	470

## N. Integrating DG-PV on Our Circuits

DG-PV Forecasts by Distribution Circuit

Circuit	OCL	HC	2016	2017	2018	2019	2020	2030	2040	2045
Circuit 151	5,020	4,267	2,519	2,886	3,155	3,270	3,389	5,731	6,082	6,082
Circuit 152	5,741	3,499	587	672	735	762	789	1,335	1,910	2,197
Circuit 153	4,106	2,067	232	265	290	301	312	527	754	867
Circuit 154	4,941	1,152	–	–	–	–	–	–	–	–
Circuit 155	5,774	4,908	–	–	–	–	–	–	–	–
Circuit 156	4,879	4,147	–	–	–	–	–	–	–	–
Circuit 157	3,629	3,084	87	87	87	87	87	87	87	87
Circuit 158	889	499	316	362	395	410	425	718	1,028	1,182
Circuit 159	2,132	984	589	675	738	765	792	1,340	1,917	2,206
Circuit 160	5,736	4,137	535	613	670	694	720	1,217	1,741	2,003
Circuit 161	6,310	4,551	1,246	1,427	1,560	1,617	1,676	2,834	3,989	3,989
Circuit 162	4,056	3,448	364	416	455	472	489	827	1,159	1,159
Circuit 163	1,911	1,624	206	208	208	208	208	208	208	208
Circuit 164	725	920	629	720	788	816	846	1,431	1,467	1,467
Circuit 165	1,877	1,595	–	–	–	–	–	–	–	–
Circuit 166	1,032	877	398	455	498	516	535	904	1,294	1,489
Circuit 167	5,120	4,352	578	662	724	750	778	1,315	1,881	2,165
Circuit 168	3,546	963	1,226	1,404	1,535	1,592	1,649	2,789	3,990	4,591
Circuit 169	4,029	2,935	3,628	4,156	4,544	4,710	4,882	5,088	5,088	5,088
Circuit 170	1,120	952	409	469	513	532	551	932	1,333	1,533
Circuit 171	4,969	3,827	248	284	311	322	334	565	808	930
Circuit 172	2,755	2,342	362	414	453	469	487	823	1,177	1,354
Circuit 173	624	531	442	506	554	574	595	1,006	1,439	1,469
Circuit 174	3,230	2,745	928	1,063	1,162	1,205	1,248	2,111	3,001	3,001
Circuit 175	7,927	5,784	692	792	866	898	930	1,573	2,251	2,590
Circuit 176	721	613	–	–	–	–	–	–	–	–
Circuit 177	4,497	3,822	1,617	1,852	2,025	2,099	2,175	3,679	4,211	4,211
Circuit 178	7,024	6,024	1,275	1,460	1,596	1,655	1,715	2,900	3,764	3,764
Circuit 179	3,851	3,052	115	131	144	149	154	261	373	429
Circuit 180	5,782	4,088	83	95	104	108	111	188	270	310
Circuit 181	83	62	–	–	–	–	–	–	–	–
Circuit 182	3,416	2,510	116	133	145	150	156	263	377	433
Circuit 183	11,185	9,507	500	573	626	649	673	1,138	1,627	1,872
Circuit 184	5,907	5,021	270	309	338	351	363	614	879	1,011
Circuit 185	6,299	5,354	1,945	2,228	2,436	2,525	2,617	4,425	5,022	5,022
Circuit 186	1,088	707	957	1,097	1,199	1,243	1,288	2,178	3,116	3,534
Circuit 187	3,487	2,964	355	407	445	461	478	808	1,156	1,330
Circuit 188	6,420	5,641	282	323	354	367	380	642	919	1,057

## N. Integrating DG-PV on Our Circuits

DG-PV Forecasts by Distribution Circuit

Circuit	OCL	HC	2016	2017	2018	2019	2020	2030	2040	2045
Circuit 189	60	52	–	–	–	–	–	–	–	–
Circuit 190	4,546	3,864	–	–	–	–	–	–	–	–
Circuit 191	3,108	2,642	2,350	2,692	2,944	3,052	3,162	5,347	5,473	5,473
Circuit 192	1,030	450	635	727	795	824	854	1,444	2,065	2,376
Circuit 193	3,249	759	–	–	–	–	–	–	–	–
Circuit 194	4,897	4,163	1,897	2,173	2,376	2,462	2,552	4,315	4,339	4,339
Circuit 195	4,138	3,518	1,373	1,573	1,720	1,783	1,848	2,547	2,547	2,547
Circuit 196	7,671	6,520	2,649	3,034	3,318	3,439	3,564	6,026	8,157	8,157
Circuit 197	10,634	9,039	4,440	5,087	5,562	5,765	5,975	9,517	9,517	9,517
Circuit 198	952	809	203	232	254	263	268	268	268	268
Circuit 199	4,410	3,749	1,676	1,920	2,099	2,176	2,255	3,813	4,618	4,618
Circuit 200	4,112	1,608	1,137	1,303	1,425	1,477	1,530	2,588	3,400	3,400
Circuit 201	4,019	3,416	2,551	2,922	3,195	3,312	3,432	5,804	6,161	6,161
Circuit 202	4,355	2,666	1,694	1,941	2,122	2,199	2,279	3,854	3,897	3,897
Circuit 203	505	430	87	100	109	113	117	144	144	144
Circuit 204	5,370	4,565	39	44	48	50	52	88	126	144
Circuit 205	983	835	–	–	–	–	–	–	–	–
Circuit 206	3,562	3,027	–	–	–	–	–	–	–	–
Circuit 207	4,274	3,083	58	66	72	75	78	131	188	216
Circuit 208	3,627	1,295	836	957	1,046	1,085	1,124	1,901	2,720	3,129
Circuit 209	1,711	1,454	545	624	683	708	733	1,240	1,774	2,041
Circuit 210	3,125	2,693	1,537	1,761	1,925	1,995	2,068	3,497	5,003	5,078
Circuit 211	6,616	5,808	3,213	3,680	4,024	4,171	4,323	7,310	9,474	9,474
Circuit 212	5,706	5,033	2,562	2,935	3,209	3,327	3,448	5,830	7,214	7,214
Circuit 213	1,903	1,471	1,139	1,304	1,426	1,478	1,532	2,591	3,706	4,113
Circuit 214	8,176	6,950	350	401	438	454	471	796	1,139	1,311
Circuit 215	5,354	3,717	1,590	1,821	1,992	2,064	2,139	3,618	4,244	4,244
Circuit 216	2,008	1,706	609	697	762	790	819	1,385	1,464	1,464
Circuit 217	5,447	4,630	1,120	1,283	1,403	1,454	1,464	1,464	1,464	1,464
Circuit 218	3,541	3,010	1,371	1,570	1,717	1,780	1,845	3,119	4,462	4,877
Circuit 219	179	152	–	–	–	–	–	–	–	–
Circuit 220	2,869	2,438	1,993	2,283	2,497	2,588	2,682	4,535	6,316	6,316
Circuit 221	6,009	4,641	1,722	1,973	2,157	2,236	2,317	3,918	5,606	5,659
Circuit 222	2,079	1,767	1,602	1,835	2,006	2,080	2,155	3,645	4,802	4,802
Circuit 223	5,005	2,998	907	1,039	1,136	1,177	1,220	2,063	2,952	3,163
Circuit 224	2,919	2,127	350	401	438	454	471	796	1,029	1,029
Circuit 225	8,145	6,776	863	989	1,081	1,121	1,162	1,964	2,810	3,233
Circuit 226	1,186	578	322	369	404	419	434	734	1,050	1,207



## N. Integrating DG-PV on Our Circuits

DG-PV Forecasts by Distribution Circuit

Circuit	OCL	HC	2016	2017	2018	2019	2020	2030	2040	2045
Circuit 227	190	162	35	40	43	45	47	79	88	88
Circuit 228	2,419	676	917	1,050	1,148	1,190	1,233	2,086	2,984	3,433
Circuit 229	7,351	6,249	2,573	2,948	3,223	3,341	3,462	5,854	6,995	6,995
Circuit 230	4,579	3,892	1,027	1,177	1,287	1,334	1,382	2,337	3,344	3,847
Circuit 231	2,090	1,777	599	686	751	778	806	1,363	1,951	2,244
Circuit 232	4,899	4,237	96	110	120	125	129	218	312	360
Circuit 233	7,858	4,263	2,930	3,356	3,669	3,804	3,942	6,665	8,207	8,207
Circuit 234	1,663	1,532	294	337	369	382	396	669	679	679
Circuit 235	5,011	4,027	2,338	2,679	2,929	3,036	3,146	4,380	4,380	4,380
Circuit 236	8,704	4,964	3,984	4,564	4,990	5,172	5,360	8,657	8,657	8,657
Circuit 237	4,312	4,027	2,592	2,969	3,246	3,365	3,487	5,896	7,079	7,079
Circuit 238	748	717	958	1,097	1,199	1,243	1,288	2,179	2,328	2,328
Circuit 239	3,566	3,031	1,897	2,173	2,376	2,463	2,553	4,316	6,175	7,061
Circuit 240	4,602	4,036	2	3	3	3	3	6	8	9
Circuit 241	8,243	6,839	2,600	2,978	3,256	3,376	3,498	3,515	3,515	3,515
Circuit 242	1,597	1,256	365	418	457	474	491	830	1,188	1,366
Circuit 243	177	2,344	–	–	–	–	–	–	–	–
Circuit 244	2,979	3,794	679	777	850	881	913	1,544	2,209	2,541
Circuit 245	5,261	3,543	2,168	2,484	2,716	2,815	2,917	4,933	5,756	5,756
Circuit 246	711	226	–	–	–	–	–	–	–	–
Circuit 247	4,259	3,857	438	502	548	568	589	996	1,425	1,640
Circuit 248	4,452	793	1,099	1,259	1,376	1,426	1,478	2,500	3,410	3,410
Circuit 249	3,632	432	228	261	286	296	307	519	743	855
Circuit 250	2,345	1,993	1,140	1,306	1,428	1,480	1,534	2,593	3,630	3,630
Circuit 251	8,975	5,107	8,105	9,284	10,152	10,413	10,413	10,413	10,413	10,413
Circuit 252	2,897	963	1,507	1,726	1,887	1,956	2,027	3,428	4,128	4,128
Circuit 253	108	92	–	–	–	–	–	–	–	–
Circuit 254	7,195	6,288	585	670	733	759	787	1,331	1,776	1,776
Circuit 255	5,548	5,328	536	614	672	696	722	1,220	1,740	1,740
Circuit 256	3,836	3,624	726	832	910	943	977	1,653	1,989	1,989
Circuit 257	5,354	5,059	1,474	1,688	1,846	1,914	1,983	3,353	4,798	5,520
Circuit 258	5,212	2,335	4,705	5,390	5,893	6,109	6,331	8,958	8,958	8,958
Circuit 259	3,216	2,781	6,168	6,253	6,253	6,253	6,253	6,253	6,253	6,253
Circuit 260	8,148	5,689	4,628	5,301	5,796	6,009	6,227	10,529	13,715	13,715
Circuit 261	4,605	3,914	2,195	2,515	2,750	2,850	2,954	4,995	6,101	6,101
Circuit 262	5,475	4,654	1,483	1,699	1,858	1,926	1,996	3,375	4,276	4,276
Circuit 263	3,763	3,199	2,552	2,923	3,196	3,271	3,271	3,271	3,271	3,271
Circuit 264	5,762	4,898	4,075	4,668	5,104	5,291	5,483	5,637	5,637	5,637

## N. Integrating DG-PV on Our Circuits

DG-PV Forecasts by Distribution Circuit

Circuit	OCL	HC	2016	2017	2018	2019	2020	2030	2040	2045
Circuit 265	5,107	3,907	762	873	954	989	1,025	1,733	1,925	1,925
Circuit 266	3,937	3,346	182	208	228	236	245	414	592	681
Circuit 267	2,933	2,493	471	540	590	612	634	650	650	650
Circuit 268	6,033	5,128	1,623	1,859	2,033	2,107	2,184	3,692	5,283	5,706
Circuit 269	4,641	3,945	–	–	–	–	–	–	–	–
Circuit 270	4,421	3,758	1,116	1,278	1,398	1,449	1,501	2,539	3,098	3,098
Circuit 271	4,171	3,545	2,511	2,876	3,144	3,260	3,378	5,712	6,041	6,041
Circuit 272	1,154	981	495	567	620	643	666	1,126	1,611	1,853
Circuit 273	2,143	1,822	457	524	573	594	615	1,041	1,489	1,713
Circuit 274	2,946	2,504	1,520	1,742	1,904	1,974	2,046	3,459	4,389	4,389
Circuit 275	7,570	5,984	3,619	4,146	4,533	4,699	4,870	6,395	6,395	6,395
Circuit 276	3,122	3,475	4,129	4,129	4,129	4,129	4,129	4,129	4,129	4,129
Circuit 277	4,614	4,103	2,334	2,674	2,924	3,031	3,141	5,311	6,926	6,926
Circuit 278	4,340	3,953	2,186	2,504	2,738	2,838	2,941	4,974	6,154	6,154
Circuit 279	1,177	1,057	986	1,129	1,235	1,280	1,326	1,798	1,798	1,798
Circuit 280	2,936	2,495	897	1,027	1,123	1,164	1,206	2,040	2,919	3,358
Circuit 281	1,316	772	1,169	1,339	1,464	1,518	1,573	2,660	3,496	3,496
Circuit 282	4,214	780	1,137	1,302	1,424	1,476	1,530	2,587	3,701	4,258
Circuit 283	3,839	2,871	1,028	1,177	1,287	1,335	1,383	2,339	3,346	3,849
Circuit 284	2,299	1,954	1,798	2,059	2,251	2,334	2,419	4,090	4,985	4,985
Circuit 285	5,662	1,636	2,961	3,392	3,709	3,845	3,984	6,737	7,920	7,920
Circuit 286	5,271	4,480	33	38	42	43	45	76	109	125
Circuit 287	3,252	2,048	1,978	2,266	2,478	2,568	2,662	4,501	4,863	4,863
Circuit 288	9,600	3,270	3,026	3,466	3,790	3,928	4,071	6,802	6,802	6,802
Circuit 289	2,667	3,617	265	304	332	344	357	603	862	992
Circuit 290	2,772	1,028	1,170	1,340	1,464	1,464	1,464	1,464	1,464	1,464
Circuit 291	4,820	3,749	968	1,109	1,213	1,257	1,303	2,203	3,152	3,627
Circuit 292	5,222	2,086	970	1,112	1,215	1,260	1,306	2,208	3,111	3,111
Circuit 293	5,768	4,903	1,383	1,464	1,464	1,464	1,464	1,464	1,464	1,464
Circuit 294	6,307	3,281	767	878	960	996	1,032	1,745	2,496	2,871
Circuit 295	4,017	3,617	328	376	411	426	442	747	903	903
Circuit 296	4,136	2,357	412	472	516	535	555	938	1,342	1,361
Circuit 297	3,545	1,694	1,575	1,804	1,973	2,045	2,119	3,583	4,239	4,239
Circuit 298	4,054	3,446	2,444	2,800	3,062	3,174	3,289	5,561	5,972	5,972
Circuit 299	6,304	3,496	844	967	1,057	1,096	1,136	1,921	2,748	3,162
Circuit 300	4,455	1,469	1,791	2,052	2,243	2,325	2,410	4,075	5,830	6,707
Circuit 301	1,053	496	484	554	606	628	651	1,100	1,574	1,811
Circuit 302	4,019	3,416	1,763	2,019	2,208	2,288	2,372	4,010	5,737	5,758

## N. Integrating DG-PV on Our Circuits

DG-PV Forecasts by Distribution Circuit

Circuit	OCL	HC	2016	2017	2018	2019	2020	2030	2040	2045
Circuit 303	6,695	3,596	4,674	5,354	5,854	6,068	6,289	10,430	10,430	10,430
Circuit 304	2,526	2,147	1,365	1,564	1,710	1,772	1,837	2,893	2,893	2,893
Circuit 305	1,852	740	964	1,105	1,208	1,252	1,298	2,194	3,139	3,611
Circuit 306	2,635	1,809	68	78	85	88	91	155	221	254
Circuit 307	4,943	4,202	2,091	2,395	2,619	2,715	2,813	4,757	5,801	5,801
Circuit 308	1,236	1,051	1,080	1,237	1,352	1,402	1,453	2,457	3,039	3,039
Circuit 309	1,140	714	469	537	587	609	631	1,067	1,527	1,757
Circuit 310	6,808	5,787	465	532	582	603	625	1,057	1,512	1,740
Circuit 311	6,285	5,342	460	527	576	597	619	1,047	1,497	1,723
Circuit 312	3,034	2,579	–	–	–	–	–	–	–	–
Circuit 313	3,923	2,934	1,799	2,061	2,254	2,336	2,421	4,094	4,949	4,949
Circuit 314	5,183	4,405	1,612	1,846	2,019	2,093	2,169	3,667	3,805	3,805
Circuit 315	3,086	2,623	489	560	612	635	658	1,112	1,591	1,831
Circuit 316	1,536	1,305	265	304	332	344	357	603	731	731
Circuit 317	5,006	3,868	48	55	60	62	65	109	157	180
Circuit 318	5,261	3,540	216	247	271	280	291	491	703	809
Circuit 319	4,865	4,135	349	400	438	454	470	795	1,137	1,308
Circuit 320	5,762	2,253	2,266	2,596	2,838	2,942	3,049	5,155	5,474	5,474
Circuit 321	337	287	79	90	99	102	106	179	256	295
Circuit 322	4,669	4,724	747	856	936	970	1,005	1,620	1,620	1,620
Circuit 323	144	123	–	–	–	–	–	–	–	–
Circuit 324	5,894	5,010	2,371	2,716	2,970	3,079	3,190	3,581	3,581	3,581
Circuit 325	608	588	501	574	628	651	675	1,141	1,632	1,878
Circuit 326	1,410	762	858	983	1,074	1,114	1,154	1,952	2,792	3,212
Circuit 327	1,463	511	1,311	1,502	1,511	1,511	1,511	1,511	1,511	1,511
Circuit 328	6,119	5,201	3,099	3,550	3,882	4,024	4,170	7,051	7,283	7,283
Circuit 329	1,610	1,369	1,053	1,206	1,318	1,367	1,416	2,395	3,426	3,519
Circuit 330	5,881	4,999	3,528	4,041	4,419	4,580	4,747	6,592	6,592	6,592
Circuit 331	924	785	95	108	119	123	127	215	308	355
Circuit 332	7,351	3,171	3,679	4,215	4,608	4,777	4,951	8,371	10,701	10,701
Circuit 333	5,964	5,069	1,020	1,168	1,277	1,324	1,372	2,320	3,319	3,818
Circuit 334	2,507	2,131	479	549	600	622	645	1,090	1,560	1,795
Circuit 335	3,598	3,058	1,369	1,568	1,714	1,777	1,842	2,649	2,649	2,649
Circuit 336	5,827	4,953	2,046	2,344	2,563	2,657	2,753	4,210	4,210	4,210
Circuit 337	3,697	3,143	1,061	1,216	1,329	1,378	1,428	2,415	3,455	3,975
Circuit 338	959	815	204	233	255	264	274	463	663	762
Circuit 339	9,020	7,667	2,362	2,705	2,958	3,066	3,178	4,111	4,111	4,111
Circuit 340	3,646	3,099	1,452	1,663	1,818	1,885	1,953	3,303	4,675	4,675

## N. Integrating DG-PV on Our Circuits

DG-PV Forecasts by Distribution Circuit

Circuit	OCL	HC	2016	2017	2018	2019	2020	2030	2040	2045
Circuit 341	746	634	–	–	–	–	–	–	–	–
Circuit 342	4,140	1,454	1,864	2,136	2,335	2,421	2,509	4,242	6,069	6,982
Circuit 343	5,806	4,935	2,484	2,845	3,111	3,225	3,342	5,651	5,760	5,760
Circuit 344	4,257	3,619	1,738	1,991	2,177	2,257	2,339	3,468	3,468	3,468
Circuit 345	9,447	6,464	738	845	924	958	993	1,679	2,402	2,764
Circuit 346	4,257	3,619	1,580	1,810	1,979	2,052	2,126	3,596	4,565	4,565
Circuit 347	6,038	3,233	2,664	3,052	3,337	3,459	3,584	6,061	7,164	7,164
Circuit 348	3,111	1,014	1,179	1,351	1,477	1,531	1,587	2,683	3,838	4,416
Circuit 349	419	356	473	542	592	614	636	1,076	1,539	1,770
Circuit 350	6,149	3,240	2,547	2,918	3,191	3,307	3,428	5,796	7,505	7,505
Circuit 351	3,133	2,663	–	–	–	–	–	–	–	–
Circuit 352	2,391	1,567	44	44	44	44	44	44	44	44
Circuit 353	7,969	5,222	–	–	–	–	–	–	–	–
Circuit 354	6,602	5,612	24	27	30	31	32	55	78	90
Circuit 355	6,104	5,188	121	139	152	157	163	276	395	454
Circuit 356	3,888	3,304	46	53	58	60	62	105	150	172
Circuit 357	4,256	3,618	–	–	–	–	–	–	–	–
Circuit 358	2,982	2,535	1,070	1,226	1,340	1,389	1,440	2,435	3,483	3,940
Circuit 359	6,054	949	3,858	4,420	4,833	5,009	5,191	8,778	11,248	11,248
Circuit 360	1,341	513	595	682	746	773	801	1,355	1,464	1,464
Circuit 361	277	122	151	173	189	196	203	343	491	565
Circuit 362	6,306	5,364	1,308	1,499	1,639	1,699	1,761	2,977	4,259	4,433
Circuit 363	4,376	3,725	1,679	1,923	2,103	2,180	2,259	3,517	3,517	3,517
Circuit 364	5,368	4,562	3,881	4,445	4,861	5,038	5,221	7,650	7,650	7,650
Circuit 365	4,712	2,283	1,561	1,788	1,956	2,027	2,101	3,552	5,003	5,003
Circuit 366	4,162	1,910	1,120	1,283	1,403	1,455	1,507	2,549	3,647	4,196
Circuit 367	2,068	1,758	1,173	1,343	1,469	1,523	1,578	2,668	3,817	4,392
Circuit 368	4,623	1,336	1,540	1,764	1,929	1,999	2,072	3,503	5,012	5,766
Circuit 369	5,678	4,380	2,925	3,350	3,663	3,797	3,935	6,654	9,264	9,264
Circuit 370	3,020	524	526	603	659	683	708	1,198	1,713	1,971
Circuit 371	4,080	913	2,136	2,447	2,675	2,773	2,874	4,859	6,938	6,938
Circuit 372	5,743	4,882	3,688	4,225	4,620	4,789	4,962	8,391	8,592	8,592
Circuit 373	7,141	5,038	4,995	5,722	6,256	6,485	6,721	9,886	9,886	9,886
Circuit 374	4,249	3,612	1,302	1,491	1,630	1,690	1,751	2,961	3,670	3,670
Circuit 375	4,040	3,434	754	864	945	979	1,015	1,716	2,455	2,824
Circuit 376	1,431	1,216	847	971	1,061	1,100	1,140	1,928	2,223	2,223
Circuit 377	1,821	717	1,084	1,241	1,357	1,407	1,458	2,465	3,527	3,686
Circuit 378	308	262	37	42	46	47	49	83	119	137

## N. Integrating DG-PV on Our Circuits

DG-PV Forecasts by Distribution Circuit

Circuit	OCL	HC	2016	2017	2018	2019	2020	2030	2040	2045
Circuit 379	3,073	2,069	1,454	1,665	1,821	1,887	1,956	3,307	4,732	5,216
Circuit 380	1,552	1,319	1,666	1,908	2,086	2,163	2,241	3,789	4,163	4,163
Circuit 381	1,106	640	907	1,039	1,136	1,178	1,221	2,064	2,953	3,398
Circuit 382	–	–	24,363	40,100	81,458	122,815	164,173	381,960	381,960	381,960

Table N-16. Distribution Circuit High DG-PV Forecast: Hawaiian Electric (kW)

## N. Integrating DG-PV on Our Circuits

DG-PV Forecasts by Distribution Circuit

### Maui Electric Distribution Circuit Market DG-PV Forecast (kW)

Circuit	OCL	HC	2016	2017	2018	2019	2020	2030	2040	2045
Circuit 1	3,302	2,871	2,476	2,845	2,845	2,845	2,845	2,845	2,845	2,845
Circuit 2	1,233	1,072	852	873	873	873	873	873	873	873
Circuit 3	166	145	170	170	170	170	170	170	170	170
Circuit 4	22	19	32	32	32	32	32	32	32	32
Circuit 5	29	26	48	56	57	57	58	60	63	65
Circuit 6	188	163	215	215	215	215	215	215	215	215
Circuit 7	3,192	2,776	948	1,018	1,018	1,018	1,018	1,018	1,018	1,018
Circuit 8	3,602	3,132	3,063	3,536	3,592	3,592	3,592	3,592	3,592	3,592
Circuit 9	473	411	1,118	1,291	1,312	1,326	1,339	1,383	1,452	1,452
Circuit 10	330	287	998	1,033	1,033	1,033	1,033	1,033	1,033	1,033
Circuit 11	283	246	436	486	486	486	486	486	486	486
Circuit 12	77	67	9	9	9	9	9	9	9	9
Circuit 13	–	–	166	166	166	166	166	166	166	166
Circuit 14	5,807	5,049	1,452	1,452	1,452	1,452	1,452	1,452	1,452	1,452
Circuit 15	2,141	1,862	823	823	823	823	823	823	823	823
Circuit 16	5,115	4,448	2,065	2,384	2,423	2,449	2,472	2,554	2,698	2,698
Circuit 17	4,569	3,973	2,163	2,497	2,537	2,565	2,589	2,675	2,835	2,891
Circuit 18	6,033	5,246	1,447	1,670	1,697	1,715	1,732	1,789	1,896	1,985
Circuit 19	8,174	7,108	7,963	7,963	7,963	7,963	7,963	7,963	7,963	7,963
Circuit 20	1,117	971	850	895	895	895	895	895	895	895
Circuit 21	199	173	31	35	36	36	37	38	40	42
Circuit 22	5,168	4,494	2,111	2,111	2,111	2,111	2,111	2,111	2,111	2,111
Circuit 23	5,963	5,185	3,213	3,680	3,680	3,680	3,680	3,680	3,680	3,680
Circuit 24	1,133	985	3,885	4,485	4,557	4,607	4,650	4,805	4,929	4,929
Circuit 25	1,806	1,570	4,492	5,186	5,269	5,327	5,377	5,556	5,559	5,559
Circuit 26	629	547	1,337	1,337	1,337	1,337	1,337	1,337	1,337	1,337
Circuit 27	7,439	6,469	7,064	7,064	7,064	7,064	7,064	7,064	7,064	7,064
Circuit 28	539	469	571	659	670	677	684	690	690	690
Circuit 29	2,599	2,260	3,115	3,596	3,654	3,694	3,728	3,829	3,829	3,829
Circuit 30	2,103	1,829	2,901	3,350	3,398	3,398	3,398	3,398	3,398	3,398
Circuit 31	153	133	553	608	608	608	608	608	608	608
Circuit 32	6,784	5,899	1,717	1,717	1,717	1,717	1,717	1,717	1,717	1,717
Circuit 33	3,009	2,616	2,734	3,157	3,207	3,242	3,273	3,382	3,477	3,477
Circuit 34	2,091	1,818	589	680	691	697	697	697	697	697
Circuit 35	2,003	1,742	189	219	222	225	227	234	248	260
Circuit 36	2,361	2,053	3,066	3,445	3,445	3,445	3,445	3,445	3,445	3,445

## N. Integrating DG-PV on Our Circuits

DG-PV Forecasts by Distribution Circuit

Circuit	OCL	HC	2016	2017	2018	2019	2020	2030	2040	2045
Circuit 37	1,728	1,502	245	245	245	245	245	245	245	245
Circuit 38	950	826	4,619	5,333	5,342	5,342	5,342	5,342	5,342	5,342
Circuit 39	4,118	3,580	4,086	4,718	4,761	4,761	4,761	4,761	4,761	4,761
Circuit 40	2,366	2,057	570	659	669	676	683	705	748	783
Circuit 41	12,197	10,606	3,083	3,083	3,083	3,083	3,083	3,083	3,083	3,083
Circuit 42	1,255	1,091	331	382	388	392	396	409	434	454
Circuit 43	4,481	3,897	2,853	2,853	2,853	2,853	2,853	2,853	2,853	2,853
Circuit 44	1,354	1,178	1,030	1,190	1,206	1,206	1,206	1,206	1,206	1,206
Circuit 45	1,502	1,306	1,415	1,634	1,660	1,678	1,694	1,732	1,732	1,732
Circuit 46	1,286	1,119	1,210	1,210	1,210	1,210	1,210	1,210	1,210	1,210
Circuit 47	–	–	–	–	–	–	–	–	–	–
Circuit 48	1,470	1,278	670	670	670	670	670	670	670	670
Circuit 49	–	–	22	26	26	26	26	27	29	30
Circuit 50	–	–	–	–	–	–	–	–	–	–
Circuit 51	4,885	4,248	501	579	588	595	600	600	600	600
Circuit 52	2,255	1,961	3,066	3,278	3,278	3,278	3,278	3,278	3,278	3,278
Circuit 53	1,557	1,354	995	995	995	995	995	995	995	995
Circuit 54	–	–	227	227	227	227	227	227	227	227
Circuit 55	850	740	1,304	1,418	1,418	1,418	1,418	1,418	1,418	1,418
Circuit 56	319	277	476	549	558	564	569	588	589	589
Circuit 57	510	443	1,465	1,465	1,465	1,465	1,465	1,465	1,465	1,465
Circuit 58	1,424	1,238	1,892	1,912	1,912	1,912	1,912	1,912	1,912	1,912
Circuit 59	2,861	2,488	3,105	3,585	3,642	3,682	3,716	3,840	3,890	3,890
Circuit 60	1,036	901	7	8	8	8	8	9	9	10
Circuit 61	5,040	4,383	4,584	5,028	5,028	5,028	5,028	5,028	5,028	5,028
Circuit 62	1,285	1,118	395	456	463	468	473	488	518	542
Circuit 63	13,815	12,013	1,980	2,286	2,322	2,348	2,370	2,449	2,534	2,534
Circuit 64	4,346	3,779	466	466	466	466	466	466	466	466
Circuit 65	5,733	4,986	2,636	2,706	2,706	2,706	2,706	2,706	2,706	2,706
Circuit 66	714	621	34	34	34	34	34	34	34	34
Circuit 67	738	642	1,153	1,153	1,153	1,153	1,153	1,153	1,153	1,153
Circuit 68	1,792	1,558	2,328	2,688	2,731	2,760	2,786	2,871	2,871	2,871
Circuit 69	3,834	3,334	3,544	3,862	3,862	3,862	3,862	3,862	3,862	3,862
Circuit 70	3,736	3,249	1,137	1,195	1,195	1,195	1,195	1,195	1,195	1,195
Circuit 71	1,720	1,496	430	496	504	510	515	532	564	583
Circuit 72	3,406	2,962	899	1,037	1,054	1,066	1,076	1,111	1,178	1,183
Circuit 73	7,841	6,818	7,736	8,933	9,076	9,174	9,261	9,521	9,521	9,521
Circuit 74	830	722	257	297	301	305	308	311	311	311

## N. Integrating DG-PV on Our Circuits

DG-PV Forecasts by Distribution Circuit

Circuit	OCL	HC	2016	2017	2018	2019	2020	2030	2040	2045
Circuit 75	951	827	100	100	100	100	100	100	100	100
Circuit 76	4,062	3,532	2,348	2,706	2,706	2,706	2,706	2,706	2,706	2,706
Circuit 77	2,991	2,601	613	708	719	727	734	758	803	814
Circuit 78	5,882	5,115	1,443	1,666	1,693	1,694	1,694	1,694	1,694	1,694
Circuit 79	3,908	3,398	1,066	1,066	1,066	1,066	1,066	1,066	1,066	1,066
Circuit 80	3,928	3,416	438	504	504	504	504	504	504	504
Circuit 81	3,494	3,038	1,205	1,205	1,205	1,205	1,205	1,205	1,205	1,205
Circuit 82	2,645	2,300	2,754	2,974	2,974	2,974	2,974	2,974	2,974	2,974
Circuit 83	1,596	1,388	1,315	1,315	1,315	1,315	1,315	1,315	1,315	1,315
Circuit 84	3,169	2,756	2,207	2,548	2,589	2,617	2,642	2,730	2,894	2,913
Circuit 85	–	–	–	–	–	–	–	–	–	–
Circuit 86	5,449	4,738	2,896	3,344	3,398	3,435	3,467	3,488	3,488	3,488
Circuit 87	1,055	917	585	585	585	585	585	585	585	585
Circuit 88	560	487	909	909	909	909	909	909	909	909
Circuit 89	625	543	837	846	846	846	846	846	846	846
Circuit 90	418	364	597	611	611	611	611	611	611	611
Circuit 91	75	65	95	109	111	112	113	117	124	130
Circuit 92	1,002	872	1,214	1,402	1,425	1,440	1,454	1,462	1,462	1,462
Circuit 93	122	106	159	159	159	159	159	159	159	159
Circuit 94	207	180	316	364	370	374	378	390	414	433
Circuit 95	804	700	1,448	1,549	1,549	1,549	1,549	1,549	1,549	1,549
Circuit 96	276	240	299	299	299	299	299	299	299	299
Circuit 97	599	521	332	348	348	348	348	348	348	348
Circuit 98	1,037	902	56	56	56	56	56	56	56	56
Circuit 99	520	452	12	14	14	14	14	15	15	16
Circuit 100	377	328	382	382	382	382	382	382	382	382
Circuit 101	2106	1831	2,625	3,031	3,079	3,113	3,142	3,247	3,441	3,602
Circuit 102	2604	2265	644	661	661	661	661	661	661	661

Table N-17. Distribution Circuit Market DG-PV Forecast: Maui Electric (kW)



## N. Integrating DG-PV on Our Circuits

DG-PV Forecasts by Distribution Circuit

### Maui Electric Distribution Circuit High DG-PV Forecast (kW)

Circuit	OCL	HC	2016	2017	2018	2019	2020	2030	2040	2045
Circuit 1	3,302	2,871	2,661	3,114	3,269	3,367	3,435	6,436	7,697	7,697
Circuit 2	1,233	1,072	916	1,072	1,125	1,159	1,182	2,215	3,342	3,874
Circuit 3	166	145	225	263	276	285	290	544	599	599
Circuit 4	22	19	43	50	53	54	55	104	138	138
Circuit 5	29	26	52	61	64	66	67	125	189	219
Circuit 6	188	163	284	332	349	359	366	686	1,035	1,200
Circuit 7	3,192	2,776	1,019	1,094	1,094	1,094	1,094	1,094	1,094	1,094
Circuit 8	3,602	3,132	3,292	3,851	4,044	4,165	4,248	7,077	7,077	7,077
Circuit 9	473	411	1,202	1,406	1,476	1,521	1,551	2,906	4,385	5,083
Circuit 10	330	287	1,073	1,255	1,318	1,358	1,385	2,595	3,915	4,539
Circuit 11	283	246	469	549	576	593	605	1,134	1,711	1,984
Circuit 12	77	67	12	14	15	15	15	29	43	44
Circuit 13	–	–	219	256	269	277	283	530	800	927
Circuit 14	5,807	5,049	1,917	2,242	2,355	2,425	2,474	4,635	6,240	6,240
Circuit 15	2,141	1,862	1,087	1,271	1,335	1,375	1,402	2,628	3,965	4,597
Circuit 16	5,115	4,448	2,219	2,597	2,726	2,808	2,864	5,367	6,252	6,252
Circuit 17	4,569	3,973	2,324	2,719	2,855	2,941	3,000	5,621	6,816	6,816
Circuit 18	6,033	5,246	1,178	1,178	1,178	1,178	1,178	1,178	1,178	1,178
Circuit 19	8,174	7,108	9,043	9,462	9,462	9,462	9,462	9,462	9,462	9,462
Circuit 20	1,117	971	914	1,069	1,122	1,156	1,179	2,210	3,334	3,865
Circuit 21	199	173	33	38	40	42	42	79	120	139
Circuit 22	5,168	4,494	2,521	2,950	3,097	3,190	3,254	6,097	6,398	6,398
Circuit 23	5,963	5,185	3,453	4,040	4,242	4,369	4,457	7,346	7,346	7,346
Circuit 24	1,133	985	4,175	4,885	5,129	5,283	5,388	5,992	5,992	5,992
Circuit 25	1,806	1,570	4,827	5,648	5,930	6,108	6,230	8,241	8,241	8,241
Circuit 26	629	547	1,337	1,337	1,337	1,337	1,337	1,337	1,337	1,337
Circuit 27	7,439	6,469	7,708	7,708	7,708	7,708	7,708	7,708	7,708	7,708
Circuit 28	539	469	614	718	754	777	792	1,485	2,240	2,597
Circuit 29	2,599	2,260	3,347	3,916	4,112	4,236	4,320	8,096	8,236	8,236
Circuit 30	2,103	1,829	3,118	3,648	3,830	3,945	4,024	7,540	8,085	8,085
Circuit 31	153	133	594	696	730	752	767	1,438	2,169	2,515
Circuit 32	6,784	5,899	1,717	1,717	1,717	1,717	1,717	1,717	1,717	1,717
Circuit 33	3,009	2,616	2,938	3,438	3,610	3,718	3,792	6,752	6,752	6,752
Circuit 34	2,091	1,818	633	741	778	801	817	1,531	2,310	2,678
Circuit 35	2,003	1,742	203	238	250	257	263	366	366	366
Circuit 36	2,361	2,053	3,295	3,855	4,048	4,169	4,253	6,854	6,854	6,854

## N. Integrating DG-PV on Our Circuits

DG-PV Forecasts by Distribution Circuit

Circuit	OCL	HC	2016	2017	2018	2019	2020	2030	2040	2045
Circuit 37	1,728	1,502	279	327	343	353	361	535	535	535
Circuit 38	950	826	4,964	5,808	6,098	6,281	6,407	8,395	8,395	8,395
Circuit 39	4,118	3,580	4,391	5,138	5,395	5,557	5,668	7,838	7,838	7,838
Circuit 40	2,366	2,057	464	464	464	464	464	464	464	464
Circuit 41	12,197	10,606	2,598	2,598	2,598	2,598	2,598	2,598	2,598	2,598
Circuit 42	1,255	1,091	355	416	437	450	459	860	1,297	1,504
Circuit 43	4,481	3,897	3,704	4,333	4,550	4,686	4,780	6,631	6,631	6,631
Circuit 44	1,354	1,178	1,107	1,296	1,360	1,401	1,429	2,678	4,040	4,684
Circuit 45	1,502	1,306	1,520	1,779	1,868	1,924	1,962	3,677	5,548	6,432
Circuit 46	1,286	1,119	1,330	1,556	1,633	1,682	1,716	3,216	4,852	5,625
Circuit 47	-	-	-	-	-	-	-	-	-	-
Circuit 48	1,470	1,278	884	1,034	1,086	1,118	1,141	2,138	3,225	3,739
Circuit 49	-	-	24	28	29	30	31	57	87	101
Circuit 50	-	-	-	-	-	-	-	-	-	-
Circuit 51	4,885	4,248	539	630	662	682	696	1,043	1,043	1,043
Circuit 52	2,255	1,961	3,295	3,855	4,048	4,169	4,253	5,720	5,720	5,720
Circuit 53	1,557	1,354	1,200	1,200	1,200	1,200	1,200	1,200	1,200	1,200
Circuit 54	-	-	299	350	368	379	386	724	1,092	1,266
Circuit 55	850	740	1,402	1,640	1,722	1,774	1,809	3,390	5,115	5,930
Circuit 56	319	277	511	598	628	647	660	1,236	1,865	2,162
Circuit 57	510	443	1,712	2,003	2,103	2,166	2,209	4,140	6,246	6,624
Circuit 58	1,424	1,238	2,033	2,379	2,498	2,573	2,624	4,918	6,504	6,504
Circuit 59	2,861	2,488	3,337	3,904	4,099	4,222	4,306	8,070	8,628	8,628
Circuit 60	1,036	901	7	9	9	9	10	18	27	31
Circuit 61	5,040	4,383	4,927	5,764	6,052	6,234	6,359	8,835	8,835	8,835
Circuit 62	1,285	1,118	424	496	521	537	548	1,026	1,548	1,795
Circuit 63	13,815	12,013	2,128	2,489	2,614	2,692	2,746	3,617	3,617	3,617
Circuit 64	4,346	3,779	616	720	756	779	795	1,236	1,236	1,236
Circuit 65	5,733	4,986	2,833	3,315	3,481	3,585	3,657	6,852	7,565	7,565
Circuit 66	714	621	45	52	55	57	58	108	163	164
Circuit 67	738	642	1,275	1,492	1,566	1,613	1,646	3,084	4,653	5,394
Circuit 68	1,792	1,558	2,502	2,927	3,073	3,165	3,229	6,050	6,810	6,810
Circuit 69	3,834	3,334	3,808	4,456	4,679	4,819	4,915	7,941	7,941	7,941
Circuit 70	3,736	3,249	1,222	1,429	1,501	1,546	1,577	2,955	4,458	5,168
Circuit 71	1,720	1,496	462	540	567	584	596	1,117	1,686	1,954
Circuit 72	3,406	2,962	966	1,130	1,186	1,222	1,246	2,336	3,524	4,085
Circuit 73	7,841	6,818	8,314	9,190	9,190	9,190	9,190	9,190	9,190	9,190
Circuit 74	830	722	276	323	339	349	356	668	1,008	1,168

## N. Integrating DG-PV on Our Circuits

DG-PV Forecasts by Distribution Circuit

Circuit	OCL	HC	2016	2017	2018	2019	2020	2030	2040	2045
Circuit 75	951	827	132	154	162	167	170	319	481	557
Circuit 76	4,062	3,532	2,523	2,952	3,100	3,193	3,257	6,103	6,758	6,758
Circuit 77	2,991	2,601	659	735	735	735	735	735	735	735
Circuit 78	5,882	5,115	1,551	1,815	1,834	1,834	1,834	1,834	1,834	1,834
Circuit 79	3,908	3,398	1,407	1,646	1,729	1,780	1,816	3,403	5,134	5,946
Circuit 80	3,928	3,416	471	551	578	596	608	1,139	1,241	1,241
Circuit 81	3,494	3,038	1,205	1,205	1,205	1,205	1,205	1,205	1,205	1,205
Circuit 82	2,645	2,300	2,960	3,463	3,636	3,745	3,820	7,036	7,036	7,036
Circuit 83	1,596	1,388	1,735	2,030	2,132	2,196	2,240	4,197	6,332	6,769
Circuit 84	3,169	2,756	2,372	2,775	2,914	3,001	3,061	5,736	6,224	6,224
Circuit 85	–	–	–	–	–	–	–	–	–	–
Circuit 86	5,449	4,738	3,112	3,642	3,824	3,938	4,017	6,833	6,833	6,833
Circuit 87	1,055	917	717	838	880	907	925	1,733	2,615	3,031
Circuit 88	560	487	1,056	1,235	1,297	1,336	1,362	2,553	3,852	4,465
Circuit 89	625	543	900	1,052	1,105	1,138	1,161	2,176	3,282	3,805
Circuit 90	418	364	642	751	788	812	828	1,552	2,341	2,714
Circuit 91	75	65	102	119	125	129	131	246	249	249
Circuit 92	1,002	872	1,305	1,527	1,603	1,651	1,684	1,688	1,688	1,688
Circuit 93	122	106	191	208	212	218	225	366	512	593
Circuit 94	207	180	319	347	354	365	376	612	855	991
Circuit 95	804	700	1,462	1,594	1,626	1,675	1,725	1,728	1,728	1,728
Circuit 96	276	240	346	378	385	397	409	665	930	959
Circuit 97	599	521	335	365	372	383	395	500	500	500
Circuit 98	1,037	902	57	62	63	65	67	109	152	176
Circuit 99	520	452	12	13	13	14	14	23	32	37
Circuit 100	377	328	474	541	573	619	663	2,227	2,759	2,759
Circuit 101	2,106	1,831	2,188	2,188	2,188	2,188	2,188	2,188	2,188	2,188
Circuit 102	2,604	2,265	661	753	799	862	923	2,753	2,753	2,753

Table N-18. Distribution Circuit High DG-PV Forecast: Maui Electric (kW)

## N. Integrating DG-PV on Our Circuits

DG-PV Forecasts by Distribution Circuit

### Hawai'i Electric Light Distribution Circuit Market DG-PV Forecast (kW)

Circuit	OCL	HC	2016	2017	2018	2019	2020	2030	2040	2045
Circuit 1	6,279	5,337	1,334	1,549	1,612	1,659	1,706	1,996	2,370	2,701
Circuit 2	1,552	1,319	340	395	411	423	435	509	604	689
Circuit 3	1,952	1,659	–	–	–	–	–	–	–	–
Circuit 4	2,529	2,150	261	303	315	325	334	390	464	528
Circuit 5	4,994	4,245	83	96	100	103	106	124	148	168
Circuit 6	2,621	2,228	–	–	–	–	–	–	–	–
Circuit 7	4,560	3,876	925	1,074	1,117	1,150	1,183	1,384	1,643	1,872
Circuit 8	4,641	1,795	1,044	1,212	1,261	1,299	1,335	1,562	1,855	2,114
Circuit 9	846	375	217	253	263	270	278	325	386	440
Circuit 10	2,200	85	348	404	420	433	445	520	618	704
Circuit 11	199	–	–	–	–	–	–	–	–	–
Circuit 12	3,846	85	100	100	100	100	100	100	100	100
Circuit 13	1,457	83	123	142	148	153	157	184	218	248
Circuit 14	2,504	2,129	397	461	480	494	508	594	706	804
Circuit 15	149	127	7	8	8	9	9	10	12	14
Circuit 16	2,012	598	877	1,018	1,059	1,087	1,087	1,087	1,087	1,087
Circuit 17	1,602	953	292	339	352	363	373	436	518	590
Circuit 18	2,881	624	517	600	624	642	661	773	918	1,046
Circuit 19	2,223	1,597	587	681	709	730	750	878	1,042	1,188
Circuit 20	696	272	133	154	161	165	170	199	236	269
Circuit 21	3,504	1,040	1,530	1,777	1,848	1,903	1,957	2,289	2,718	3,098
Circuit 22	2,080	85	76	88	91	94	97	113	134	153
Circuit 23	5,493	2,714	2,993	3,476	3,616	3,723	3,828	4,478	5,317	6,060
Circuit 24	2,781	851	619	719	748	771	792	927	1,101	1,254
Circuit 25	8,169	2,431	4,542	5,275	5,488	5,650	5,810	6,797	8,070	9,197
Circuit 26	1,155	–	–	–	–	–	–	–	–	–
Circuit 27	3,789	3,221	1,728	2,006	2,087	2,149	2,209	2,585	3,069	3,194
Circuit 28	5,923	5,034	1,185	1,376	1,431	1,474	1,515	1,773	2,105	2,399
Circuit 29	1,408	1,196	179	207	216	222	228	267	317	362
Circuit 30	4,644	1,857	1,758	2,042	2,124	2,187	2,249	2,631	3,124	3,560
Circuit 31	8,263	7,029	1,080	1,254	1,304	1,343	1,381	1,616	1,918	2,186
Circuit 32	6,539	5,558	231	231	231	231	231	231	231	231
Circuit 33	10,737	9,123	2,510	2,915	3,032	3,122	3,210	3,755	4,459	4,808
Circuit 34	3,243	2,756	1,124	1,305	1,358	1,398	1,438	1,682	1,997	2,276
Circuit 35	312	215	281	326	339	349	359	420	499	569
Circuit 36	3,291	1,818	812	943	981	1,010	1,038	1,137	1,137	1,137

## N. Integrating DG-PV on Our Circuits

DG-PV Forecasts by Distribution Circuit

Circuit	OCL	HC	2016	2017	2018	2019	2020	2030	2040	2045
Circuit 37	841	715	109	127	132	136	139	163	194	221
Circuit 38	2,653	2,255	88	102	106	110	113	132	157	178
Circuit 39	2,479	2,107	1,006	1,168	1,215	1,251	1,287	1,505	1,787	2,037
Circuit 40	1,492	533	442	514	534	550	566	662	786	895
Circuit 41	3,459	460	631	733	762	785	807	944	1,121	1,277
Circuit 42	1,309	424	541	629	654	673	692	810	962	1,056
Circuit 43	962	81	119	138	144	148	152	178	211	241
Circuit 44	5,490	770	871	1,012	1,053	1,084	1,114	1,304	1,548	1,764
Circuit 45	1,506	764	712	827	860	885	910	1,065	1,265	1,441
Circuit 46	6,002	599	756	878	913	940	967	1,131	1,343	1,530
Circuit 47	5,097	284	298	347	361	371	382	447	530	604
Circuit 48	661	146	203	235	245	252	259	303	360	410
Circuit 49	1,526	146	144	168	174	179	184	216	256	292
Circuit 50	1,324	315	522	607	631	650	668	782	906	906
Circuit 51	1,167	2,043	1,421	1,421	1,421	1,421	1,421	1,421	1,421	1,421
Circuit 52	3,211	6,199	7,168	7,168	7,168	7,168	7,168	7,168	7,168	7,168
Circuit 53	2,988	864	1,047	1,216	1,265	1,302	1,339	1,567	1,860	2,080
Circuit 54	4,007	3,406	1,566	1,818	1,891	1,947	2,002	2,343	2,782	3,170
Circuit 55	1,677	1,425	494	574	597	614	632	739	877	1,000
Circuit 56	352	299	123	143	148	153	157	184	218	248
Circuit 57	1,035	548	429	499	519	534	549	643	763	870
Circuit 58	74	62	10	10	10	10	10	10	10	10
Circuit 59	3,462	1,758	1,648	1,914	1,991	2,050	2,108	2,466	2,928	3,337
Circuit 60	2,628	2,108	1,611	1,871	1,946	2,004	2,061	2,411	2,862	3,262
Circuit 61	1,448	1,252	945	1,097	1,141	1,175	1,209	1,414	1,679	1,913
Circuit 62	1,489	1,274	119	138	144	148	152	178	211	241
Circuit 63	1,958	940	504	586	609	627	645	754	896	1,021
Circuit 64	1,586	1,354	158	183	190	196	202	236	280	319
Circuit 65	2,879	2,471	509	591	615	633	651	762	904	1,031
Circuit 66	1,858	1,579	694	806	838	863	888	900	900	900
Circuit 67	586	498	-	-	-	-	-	-	-	-
Circuit 68	1,132	283	209	242	252	260	267	312	371	422
Circuit 69	1,920	480	402	467	486	500	514	602	714	814
Circuit 70	1,937	1,674	804	933	971	1,000	1,028	1,202	1,428	1,627
Circuit 71	2,692	2,328	400	465	484	498	512	599	711	811
Circuit 72*	n/a	n/a	n/a	n/a	n/a	n/a	n/a	n/a	n/a	n/a
Circuit 73	6,379	4,121	2,866	3,328	3,462	3,564	3,665	4,288	5,091	5,802
Circuit 74	6,752	3,386	3,543	4,115	4,281	4,407	4,532	5,302	6,295	7,174

## N. Integrating DG-PV on Our Circuits

DG-PV Forecasts by Distribution Circuit

Circuit	OCL	HC	2016	2017	2018	2019	2020	2030	2040	2045
Circuit 75	515	438	194	226	235	242	248	291	345	393
Circuit 76	7,449	3,229	2,790	3,240	3,370	3,470	3,568	4,175	4,957	5,649
Circuit 77	851	724	597	693	721	742	763	893	1,060	1,208
Circuit 78	5,542	1,949	2,658	3,087	3,211	3,306	3,400	3,977	4,723	5,382
Circuit 79	119	76	–	–	–	–	–	–	–	–
Circuit 80	226	120	–	–	–	–	–	–	–	–
Circuit 81	1,463	480	750	871	906	933	959	1,122	1,332	1,518
Circuit 82	6,860	4,489	2,500	2,904	3,021	3,110	3,198	3,741	4,442	5,062
Circuit 83	245	208	193	224	233	240	247	289	343	391
Circuit 84	227	57	72	84	87	89	92	108	128	146
Circuit 85	676	190	189	220	229	236	242	283	337	384
Circuit 86	469	399	259	301	313	322	332	388	461	525
Circuit 87	233	198	143	167	173	178	184	215	255	291
Circuit 88	9,204	7,823	1,641	1,906	1,982	2,041	2,099	2,455	2,915	3,322
Circuit 89	2,002	1,701	860	999	1,039	1,070	1,100	1,287	1,528	1,741
Circuit 90	3,210	2,805	3,300	3,300	3,300	3,300	3,300	3,300	3,300	3,300
Circuit 91	2,905	938	662	769	800	824	847	991	1,176	1,341
Circuit 92	376	122	147	171	178	183	188	220	261	298
Circuit 93	859	128	167	194	202	208	214	251	298	339
Circuit 94	324	117	161	187	194	200	205	240	285	325
Circuit 95	331	43	45	52	54	56	57	67	80	91
Circuit 96	1,129	219	182	211	220	226	233	272	323	369
Circuit 97	5,660	4,811	388	450	469	482	496	580	689	785
Circuit 98	4,943	4,202	374	434	452	465	478	559	664	757
Circuit 99	991	172	162	188	196	202	208	243	288	329
Circuit 100	1,001	851	270	313	326	336	345	404	479	546
Circuit 101	364	310	52	60	62	64	66	77	92	105
Circuit 102	2,812	2,390	636	738	768	791	813	951	1,129	1,287
Circuit 103	4,907	4,171	1,582	1,838	1,912	1,968	2,024	2,368	2,811	3,204
Circuit 104	4,623	2,681	2,622	3,045	3,167	3,261	3,353	3,923	4,658	5,309
Circuit 105	6,136	1,483	1,744	2,026	2,107	2,170	2,231	2,610	3,099	3,531
Circuit 106	722	171	175	203	212	218	224	262	311	355
Circuit 107	408	126	186	216	225	231	238	278	330	377
Circuit 108	311	–	–	–	–	–	–	–	–	–
Circuit 109	3,792	3,223	691	802	835	859	884	1,034	1,227	1,399
Circuit 110	5,574	4,738	272	316	329	339	349	408	484	552
Circuit 111	4,103	626	252	292	304	313	322	377	447	510
Circuit 112	4,693	3,989	1,143	1,327	1,381	1,422	1,462	1,710	2,031	2,314

## N. Integrating DG-PV on Our Circuits

DG-PV Forecasts by Distribution Circuit

Circuit	OCL	HC	2016	2017	2018	2019	2020	2030	2040	2045
Circuit 113	1,316	1,118	16	19	19	20	20	24	28	32
Circuit 114	798	678	133	154	161	165	170	199	236	269
Circuit 115	146	124	500	500	500	500	500	500	500	500
Circuit 116	762	648	500	500	500	500	500	500	500	500
Circuit 117	2,610	836	843	979	1,018	1,048	1,078	1,261	1,497	1,706
Circuit 118	6,995	1,070	1,164	1,352	1,406	1,448	1,489	1,742	2,068	2,357
Circuit 119	2,666	585	521	605	630	648	667	780	926	1,055
Circuit 120	2,396	2,037	856	994	1,034	1,064	1,094	1,280	1,520	1,732
Circuit 121	58	–	100	–	–	–	–	–	–	–
Circuit 122	351	167	174	202	210	216	222	260	309	352
Circuit 123	944	802	150	175	182	187	192	225	267	304
Circuit 124	1,117	16	4	4	4	5	5	5	6	7
Circuit 125	3,522	1,008	883	1,025	1,066	1,098	1,129	1,321	1,568	1,787
Circuit 126	1,518	1,129	504	585	609	627	645	754	895	1,020
Circuit 127	192	163	47	54	56	58	60	70	83	95
Circuit 128	118	101	46	53	55	57	59	69	81	93
Circuit 129	1,990	1,691	1,158	1,345	1,399	1,440	1,481	1,733	2,057	2,345
Circuit 130	816	694	463	537	559	576	592	692	822	937
Circuit 131	4,112	3,495	1,038	1,206	1,254	1,291	1,328	1,553	1,844	2,102
Circuit 132	3,475	2,954	2,236	2,597	2,701	2,782	2,860	3,346	3,973	4,528
Circuit 133	1,271	–	–	–	–	–	–	–	–	–
Circuit 134	952	–	–	–	–	–	–	–	–	–
Circuit 135	698	435	255	296	308	317	326	382	453	517
Circuit 136	1,928	1,606	611	710	738	760	782	915	1,086	1,238

\* Circuit 72 is a backup circuit without any connections.

Table N-19. Distribution Circuit Market DG-PV Forecast: Hawai'i Electric Light (kW)

## N. Integrating DG-PV on Our Circuits

DG-PV Forecasts by Distribution Circuit

### Hawai'i Electric Light Distribution Circuit High DG-PV Forecast (kW)

Circuit	OCL	HC	2016	2017	2018	2019	2020	2030	2040	2045
Circuit 1	6,279	5,337	1,904	2,325	2,484	2,544	2,606	5,591	8,837	10,210
Circuit 2	1,552	1,319	534	652	697	713	731	1,568	2,478	2,933
Circuit 3	1,952	1,659	68	83	89	91	93	200	316	374
Circuit 4	2,529	2,150	420	513	548	561	575	1,234	1,950	2,308
Circuit 5	4,994	4,245	162	198	212	217	222	476	753	891
Circuit 6	2,621	2,228	68	83	89	91	93	200	316	374
Circuit 7	4,560	3,876	1,666	2,036	2,175	2,227	2,281	4,894	7,538	7,538
Circuit 8	4,641	1,795	1,310	1,600	1,709	1,750	1,793	3,846	5,416	5,416
Circuit 9	846	375	328	401	428	439	449	964	1,524	1,804
Circuit 10	2,200	85	491	600	641	656	672	1,442	2,279	2,698
Circuit 11	199	–	68	83	89	91	93	200	316	374
Circuit 12	3,846	85	136	166	178	182	186	400	632	737
Circuit 13	1,457	83	134	163	174	178	183	392	620	734
Circuit 14	2,504	2,129	756	924	987	1,011	1,036	2,222	3,512	4,157
Circuit 15	149	127	7	9	10	10	10	22	35	41
Circuit 16	2,012	598	742	907	969	992	1,016	2,180	2,610	2,610
Circuit 17	1,602	953	365	445	476	487	499	1,071	1,692	2,003
Circuit 18	2,881	624	740	904	966	990	1,014	2,174	3,437	4,068
Circuit 19	2,223	1,597	822	1,004	1,073	1,099	1,126	2,415	3,817	4,518
Circuit 20	696	272	201	246	263	269	275	591	934	1,105
Circuit 21	3,504	1,040	1,223	1,223	1,223	1,223	1,223	1,223	1,223	1,223
Circuit 22	2,080	85	82	100	107	110	113	242	382	452
Circuit 23	5,493	2,714	4,517	5,517	5,895	6,036	6,183	13,265	17,295	17,295
Circuit 24	2,781	851	930	1,136	1,213	1,242	1,273	2,730	4,315	4,838
Circuit 25	8,169	2,431	6,101	7,453	7,963	8,154	8,352	16,854	16,854	16,854
Circuit 26	1,155	–	68	83	89	91	93	200	316	374
Circuit 27	3,789	3,221	2,331	2,848	3,042	3,115	3,191	6,846	6,960	6,960
Circuit 28	5,923	5,034	1,423	1,738	1,857	1,902	1,948	4,179	6,606	7,579
Circuit 29	1,408	1,196	280	341	365	374	383	821	1,298	1,461
Circuit 30	4,644	1,857	2,054	2,509	2,681	2,745	2,812	2,934	2,934	2,934
Circuit 31	8,263	7,029	1,608	1,964	2,098	2,149	2,201	4,280	4,280	4,280
Circuit 32	6,539	5,558	42	52	55	56	58	124	196	230
Circuit 33	10,737	9,123	3,416	4,172	4,458	4,565	4,676	10,031	15,856	17,214
Circuit 34	3,243	2,756	1,749	1,946	1,946	1,946	1,946	1,946	1,946	1,946
Circuit 35	312	215	389	475	507	520	532	1,142	1,230	1,230
Circuit 36	3,291	1,818	1,303	1,591	1,700	1,741	1,783	1,866	1,866	1,866



## N. Integrating DG-PV on Our Circuits

DG-PV Forecasts by Distribution Circuit

Circuit	OCL	HC	2016	2017	2018	2019	2020	2030	2040	2045
Circuit 37	841	715	121	148	158	162	166	355	562	665
Circuit 38	2,653	2,255	96	117	125	128	131	282	445	527
Circuit 39	2,479	2,107	1,388	1,696	1,812	1,855	1,901	4,077	5,428	5,428
Circuit 40	1,492	533	864	1,056	1,128	1,155	1,183	2,538	3,044	3,044
Circuit 41	3,459	460	1,051	1,284	1,372	1,405	1,439	3,087	3,746	3,746
Circuit 42	1,309	424	651	795	850	870	891	1,913	3,023	3,530
Circuit 43	962	81	129	158	169	173	177	380	600	710
Circuit 44	5,490	770	1,237	1,511	1,614	1,653	1,693	3,633	5,618	5,618
Circuit 45	1,506	764	1,564	1,910	2,041	2,090	2,141	2,389	2,389	2,389
Circuit 46	6,002	599	1,149	1,404	1,500	1,536	1,573	1,887	1,887	1,887
Circuit 47	5,097	284	463	565	604	618	633	1,359	2,148	2,543
Circuit 48	661	146	271	331	354	362	371	796	1,259	1,490
Circuit 49	1,526	146	251	306	327	335	343	737	1,165	1,379
Circuit 50	1,324	315	660	806	861	882	903	1,938	3,063	3,626
Circuit 51	1,167	2,043	272	332	355	363	372	798	1,262	1,494
Circuit 52	3,211	6,199	734	896	957	980	1,004	2,154	3,405	4,031
Circuit 53	2,988	864	1,436	1,754	1,874	1,919	1,966	4,217	6,666	7,808
Circuit 54	4,007	3,406	2,184	2,668	2,851	2,919	2,990	6,416	9,266	9,266
Circuit 55	1,677	1,425	709	867	926	948	971	2,084	3,293	3,737
Circuit 56	352	299	201	246	263	269	275	591	934	1,106
Circuit 57	1,035	548	499	610	652	667	684	1,437	1,437	1,437
Circuit 58	74	62	14	17	18	18	19	40	63	75
Circuit 59	3,462	1,758	2,365	2,889	3,087	3,161	3,238	6,946	8,762	8,762
Circuit 60	2,628	2,108	2,211	2,701	2,886	2,955	3,027	6,407	6,407	6,407
Circuit 61	1,448	1,252	962	962	962	962	962	962	962	962
Circuit 62	1,489	1,274	286	349	373	382	391	776	776	776
Circuit 63	1,958	940	701	856	915	937	959	2,058	3,253	3,850
Circuit 64	1,586	1,354	218	266	284	291	298	639	1,010	1,196
Circuit 65	2,879	2,471	702	857	916	938	961	2,061	3,257	3,705
Circuit 66	1,858	1,579	735	898	959	982	1,006	2,159	2,749	2,749
Circuit 67	586	498	68	83	89	91	93	200	316	374
Circuit 68	1,132	283	283	346	370	379	388	832	1,315	1,557
Circuit 69	1,920	480	552	674	720	737	755	1,620	2,560	3,031
Circuit 70	1,937	1,674	1,040	1,270	1,357	1,390	1,424	3,054	4,135	4,135
Circuit 71	2,692	2,328	1,337	1,633	1,745	1,786	1,830	3,926	6,122	6,122
Circuit 72*	n/a	n/a	n/a	n/a	n/a	n/a	n/a	n/a	n/a	n/a
Circuit 73	6,379	4,121	3,590	4,385	4,685	4,798	4,914	10,543	14,919	14,919
Circuit 74	6,752	3,386	4,561	5,572	5,953	6,096	6,244	13,396	15,389	15,389

## N. Integrating DG-PV on Our Circuits

DG-PV Forecasts by Distribution Circuit

Circuit	OCL	HC	2016	2017	2018	2019	2020	2030	2040	2045
Circuit 75	515	438	236	288	308	315	323	693	995	995
Circuit 76	7,449	3,229	3,942	4,816	5,145	5,269	5,397	11,578	12,755	12,755
Circuit 77	851	724	849	1,037	1,108	1,134	1,162	2,439	2,439	2,439
Circuit 78	5,542	1,949	3,631	4,436	4,739	4,853	4,971	8,743	8,743	8,743
Circuit 79	119	76	68	83	89	91	93	200	316	374
Circuit 80	226	120	68	83	89	91	93	200	316	374
Circuit 81	1,463	480	1,014	1,238	1,323	1,355	1,388	2,977	4,705	5,363
Circuit 82	6,860	4,489	3,039	3,712	3,966	4,062	4,160	8,925	10,103	10,103
Circuit 83	245	208	293	358	383	392	401	861	1,169	1,169
Circuit 84	227	57	84	102	109	112	114	245	388	459
Circuit 85	676	190	226	276	295	302	310	665	1,050	1,243
Circuit 86	469	399	420	513	548	561	575	1,234	1,545	1,545
Circuit 87	233	198	189	231	246	252	259	555	877	1,038
Circuit 88	9,204	7,823	3,236	3,953	4,224	4,325	4,430	4,930	4,930	4,930
Circuit 89	2,002	1,701	1,322	1,615	1,725	1,766	1,809	3,557	3,557	3,557
Circuit 90	3,210	2,805	3,300	3,300	3,300	3,300	3,300	3,300	3,300	3,300
Circuit 91	2,905	938	1,038	1,268	1,354	1,387	1,421	3,047	4,817	5,702
Circuit 92	376	122	217	265	284	290	298	638	1,009	1,194
Circuit 93	859	128	201	245	262	269	275	590	933	1,104
Circuit 94	324	117	461	563	601	616	631	1,307	1,307	1,307
Circuit 95	331	43	68	83	89	91	94	201	317	375
Circuit 96	1,129	219	343	419	448	458	469	1,007	1,592	1,884
Circuit 97	5,660	4,811	501	612	654	670	686	1,472	1,559	1,559
Circuit 98	4,943	4,202	848	1,035	1,106	1,133	1,160	1,837	1,837	1,837
Circuit 99	991	172	273	333	356	365	373	801	1,266	1,499
Circuit 100	1,001	851	426	520	556	569	583	1,250	1,976	2,339
Circuit 101	364	310	80	98	104	107	109	235	371	439
Circuit 102	2,812	2,390	881	1,076	1,150	1,177	1,206	1,425	1,425	1,425
Circuit 103	4,907	4,171	2,107	2,574	2,750	2,816	2,885	6,189	7,161	7,161
Circuit 104	4,623	2,681	3,043	3,615	3,615	3,615	3,615	3,615	3,615	3,615
Circuit 105	6,136	1,483	2,274	2,777	2,968	3,039	3,113	4,984	4,984	4,984
Circuit 106	722	171	283	346	369	378	387	831	1,313	1,554
Circuit 107	408	126	202	247	264	270	277	594	701	701
Circuit 108	311	–	68	83	89	91	93	200	316	374
Circuit 109	3,792	3,223	1,406	1,409	1,409	1,409	1,409	1,409	1,409	1,409
Circuit 110	5,574	4,738	825	1,008	1,077	1,103	1,130	1,775	1,775	1,775
Circuit 111	4,103	626	521	636	679	696	713	1,472	1,472	1,472
Circuit 112	4,693	3,989	1,433	1,433	1,433	1,433	1,433	1,433	1,433	1,433

## N. Integrating DG-PV on Our Circuits

DG-PV Forecasts by Distribution Circuit

Circuit	OCL	HC	2016	2017	2018	2019	2020	2030	2040	2045
Circuit 113	1,316	1,118	17	21	23	23	24	51	81	96
Circuit 114	798	678	185	226	241	247	253	543	858	1,016
Circuit 115	146	124	680	758	758	758	758	758	758	758
Circuit 116	762	648	680	710	710	710	710	710	710	710
Circuit 117	2,610	836	1,366	1,668	1,782	1,825	1,869	4,011	6,339	7,369
Circuit 118	6,995	1,070	2,138	2,612	2,791	2,858	2,927	6,153	6,153	6,153
Circuit 119	2,666	585	954	1,165	1,245	1,274	1,305	2,800	4,427	4,952
Circuit 120	2,396	2,037	1,299	1,587	1,696	1,736	1,778	3,815	6,031	6,571
Circuit 121	58	–	136	166	178	182	186	400	632	748
Circuit 122	351	167	271	331	353	362	371	795	1,257	1,264
Circuit 123	944	802	234	286	305	313	320	687	1,087	1,286
Circuit 124	1,117	16	679	829	886	907	929	957	957	957
Circuit 125	3,522	1,008	1,620	1,979	2,115	2,165	2,218	4,758	5,067	5,067
Circuit 126	1,518	1,129	686	838	895	917	939	2,014	3,184	3,768
Circuit 127	192	163	51	62	66	68	70	149	236	280
Circuit 128	118	101	146	179	191	196	200	430	680	805
Circuit 129	1,990	1,691	1,661	2,029	2,168	2,220	2,274	3,257	3,257	3,257
Circuit 130	816	694	744	909	971	994	1,019	1,084	1,084	1,084
Circuit 131	4,112	3,495	1,227	1,499	1,601	1,640	1,679	3,603	5,695	6,741
Circuit 132	3,475	2,954	3,196	3,904	4,171	4,271	4,375	9,235	9,235	9,235
Circuit 133	1,271	–	68	83	89	91	93	200	316	374
Circuit 134	952	–	68	83	89	91	93	200	316	374
Circuit 135	698	435	493	603	644	659	675	1,449	2,111	2,111
Circuit 136	1,928	1,606	874	1,067	1,140	1,167	1,196	2,565	4,055	4,800

\* Circuit 72 is a backup circuit without any connections.

Table N-20. Distribution Circuit High DG-PV Forecast: Hawai'i Electric Light (kW)

## INTEGRATION STRATEGY COST ESTIMATES

Table N-21 through Table N-55 include the annualized cost and volumes of for each integration strategy, by island, in the near-, mid-, and long-term planning horizons.

Upgrade [Nominal \$000]	2016–2020	2021–2030	2031–2045	Total
Voltage Regulators	\$11,336	\$3,322	\$6,125	\$20,784
Distribution Transformer	\$12,565	\$13,737	–	\$26,302
Overhead Conductor	\$1,574	\$2,584	\$6,480	\$10,638
Underground Conductor	\$951	\$1,547	\$1,358	\$3,856
Substation Transformer	\$17,977	\$12,433	\$61,874	\$92,284
46kV Grounding Transformer	\$19,904	\$11,048	\$6,651	\$37,602
<b>Grand Total</b>	<b>\$64,307</b>	<b>\$44,672</b>	<b>\$82,488</b>	<b>\$191,466</b>
Voltage Regulators (qty)	259	68	99	426
Distribution Transformer (qty)	880	880	–	1,760
Overhead Conductor (feet)	7	11	20	38
Underground Conductor (feet)	1,133	1,601	1,171	3,905
Substation Transformer (qty)	5	4	12	21
46kV Grounding Transformer (qty)	20	10	5	35

Table N-21. Integration Strategy 1 Annualized Cost and Volumes: O’ahu

Upgrade [Nominal \$000]	2016–2020	2021–2030	2031–2045	Total
BESS	\$116,445	\$43,630	\$103,495	\$263,570
Replacement BESS	–	\$77,815	\$155,004	\$232,819
Var Compensation Devices	\$7,300	\$14,552	\$27,776	\$49,628.09
DER Controls	\$15,792	\$25,925	\$42,838	\$84,554
46kV Grounding Transformer	\$19,904	\$11,048	\$6,651	\$37,602
<b>Grand Total</b>	<b>\$159,440</b>	<b>\$172,969</b>	<b>\$335,764</b>	<b>\$668,174</b>
BESS (kW)	30,817	16,682	45,022	92,521
BESS (kWh)	123,268	66,728	180,088	370,084
Replacement BESS (kW)	–	30,817	67,523	98,340
Replacement BESS (kWh)	–	123,268	270,092	393,360
Var Compensation Devices (kW)	8,283	14,383	21,861	44,527
46kV Grounding Transformer (qty)	20	10	5	35

Table N-22. Integration Strategy 2 Annualized Cost and Volumes: O’ahu

## N. Integrating DG-PV on Our Circuits

### Integration Strategy Cost Estimates

Upgrade [Nominal \$000]	2016–2020	2021–2030	2031–2045	Total
Substation Transformer	\$4,072	–	–	\$4,072
Var Compensation Devices	\$3,786	\$14,552	\$27,776	\$46,114
Overhead Conductor	\$1,574	\$2,584	\$6,480	\$10,638
Underground Conductor	\$951	\$1,547	\$1,358	\$3,856
DER Controls	\$15,792	\$25,925	\$42,838	\$84,554
46kV Grounding Transformer	\$19,904	\$11,048	\$6,651	\$37,602
<i>Grand Total</i>	<i>\$52,203</i>	<i>\$55,656</i>	<i>\$85,103</i>	<i>\$192,961</i>
Voltage Regulators (qty)	140	–	–	140
Substation Transformer (qty)	2	–	–	2
Var Compensation Devices (kW)	8,283	14,383	21,861	44,527
Overhead Conductor (feet)	7,278	10,582	20,370	38,230
Underground Conductor (feet)	1,133	1,601	1,171	3,905
46kV Grounding Transformer (qty)	20	10	5	35

Table N-23. Integration Strategy 3 Annualized Cost and Volumes: O’ahu

Upgrade [Nominal \$000]	2016–2020	2021–2030	2031–2045	Total
Voltage Regulators	\$12,130	\$11,260	\$7,324	\$30,714
Distribution Transformer	\$25,237	\$27,591	–	\$52,828
Overhead Conductor	\$2,454	\$7,654	\$15,366	\$25,473
Underground Conductor	\$994	\$6,062	\$8,544	\$15,600
Substation Transformer	\$41,281	\$138,875	\$164,473	\$344,629
46kV Grounding Transformer	\$19,886	\$16,921	-	\$36,806
<i>Grand Total</i>	<i>\$101,981</i>	<i>\$208,362</i>	<i>\$195,707</i>	<i>\$506,051</i>
Voltage Regulators (qty)	270	214	107	591
Distribution Transformer (qty)	1,770	1,770	–	3,540
Overhead Conductor (feet)	11,448	30,517	50,316	92,281
Underground Conductor (feet)	1,173	6,172	7,129	14,474
Substation Transformer (qty)	9	46	32	87
46kV Grounding Transformer (qty)	20	15	-	35

Table N-24. Integration Strategy 4 Annualized Cost and Volumes: O’ahu

## N. Integrating DG-PV on Our Circuits

### Integration Strategy Cost Estimates

Upgrade [Nominal \$000]	2016–2020	2021–2030	2031–2045	Total
Voltage Regulators	\$12,130	\$11,260	\$7,324	\$30,714
Distribution Transformer	\$25,237	\$27,591	–	\$52,828
Overhead Conductor	\$2,454	\$7,654	\$15,366	\$25,473
Underground Conductor	\$994	\$6,062	\$8,544	\$15,600
Substation Transformer	\$31,934	\$40,316	\$84,797	\$157,047
DER Controls	\$52,560	\$141,901	\$63,974	\$258,436
46kV Grounding Transformer	\$19,886	\$16,921	-	\$36,806
<b>Grand Total</b>	<b>\$145,194</b>	<b>\$251,705</b>	<b>\$180,005</b>	<b>\$576,904</b>
Voltage Regulators (qty)	270	214	107	591
Distribution Transformer (qty)	1,770	1,770	–	3,540
Overhead Conductor (feet)	11,448	30,517	50,316	92,281
Underground Conductor (feet)	1,173	6,172	7,129	14,474
Substation Transformer (qty)	6	11	20	37
46kV Grounding Transformer (qty)	20	15	-	35

Table N-25. Integration Strategy 5 Annualized Cost and Volumes: O’ahu

Upgrade [Nominal \$000]	2016–2020	2021–2030	2031–2045	Total
BESS	\$129,997	\$381,236	\$427,831	\$939,064
Replacement BESS	–	\$69,845	\$600,370	\$670,214
Var Compensation Devices	\$9,641	\$25,831	\$23,790	\$59,262
DER Controls	\$52,560	\$141,901	\$63,974	\$258,436
46kV Grounding Transformer	\$19,886	\$16,921	-	\$36,806
<b>Grand Total</b>	<b>\$212,083</b>	<b>\$635,733</b>	<b>\$1,115,965</b>	<b>\$1,963,782</b>
BESS (kW)	27,662	118,686	148,554	294,902
BESS (kWh)	110,648	474,744	594,216	1,179,608
Replacement BESS (kW)	–	27,662	262,385	290,047
Replacement BESS (kWh)	–	110,648	1,049,540	1,160,188
Var Compensation Devices (kW)	10,906	25,317	19,467	55,690
46kV Grounding Transformer (qty)	20	15	-	35

Table N-26. Integration Strategy 6 Annualized Cost and Volumes: O’ahu

## N. Integrating DG-PV on Our Circuits

### Integration Strategy Cost Estimates

Upgrade [Nominal \$000]	2016–2020	2021–2030	2031–2045	Total
Voltage Regulators	\$6,060	–	–	\$6,060
Substation Transformer	\$4,072	–	–	\$4,072
Var Compensation Devices	\$5,522	\$25,831	\$23,790	\$55,143
BESS	–	\$17,232	\$99,427	\$116,659
Replacement BESS	–	–	\$27,666	\$27,666
Overhead Conductor	\$2,454	\$7,654	\$15,366	\$25,473
Underground Conductor	\$994	\$6,062	\$8,544	\$15,600
DER Controls	\$52,560	\$141,901	\$63,974	\$258,436
46kV Grounding Transformer	\$19,886	\$16,921	-	\$36,806
<b>Grand Total</b>	<b>\$91,547</b>	<b>\$215,601</b>	<b>\$238,768</b>	<b>\$545,915</b>
Voltage Regulators (qty)	137	–	–	137
Substation Transformer (qty)	2	–	–	2
Var Compensation Devices (kW)	10,906	25,317	19,467	55,690
BESS (kW)	–	5,083	31,056	36,139
BESS (kWh)	–	20,332	124,224	144,556
Replacement BESS (kW)	–	–	12,182	12,182
Replacement BESS (kWh)	–	–	48,728	48,728
Overhead Conductor (feet)	11,448	30,517	50,316	92,281
Underground Conductor (feet)	1,173	6,172	7,129	14,474
46kV Grounding Transformer (qty)	20	15	-	35

Table N-27. Integration Strategy 7 Annualized Cost and Volumes: O’ahu

Upgrade [Nominal \$000]	2016–2020	2021–2030	2031–2045	Total
Voltage Regulators	\$4,720	–	–	\$4,720
Distribution Transformer	\$4,426	\$4,839	–	\$9,265
Overhead Conductor	\$5,332	\$1,901	\$348	\$7,582
Underground Conductor	\$5,114	\$102	\$71	\$5,286
Substation Transformer	\$42,704	\$4,781	\$5,033	\$52,518
<b>Grand Total</b>	<b>\$62,296</b>	<b>\$11,623</b>	<b>\$5,451</b>	<b>\$79,370</b>
Voltage Regulators (qty)	111	–	–	111
Distribution Transformer (qty)	310	310	–	620
Overhead Conductor (feet)	25,244	7,786	1,211	34,242
Underground Conductor (feet)	6,236	110	61	6,407
Substation Transformer (qty)	16	1	3	20

Table N-28. Integration Strategy I Annualized Cost and Volumes: Maui

## N. Integrating DG-PV on Our Circuits

Integration Strategy Cost Estimates

Upgrade [Nominal \$000]	2016-2020	2021-2030	2031-2045	Total
BESS	\$69,775	\$2,981	\$858	\$73,614
Replacement BESS	–	\$45,226	\$45,705	\$90,931
Var Compensation Devices	\$8,951	\$2,742	\$975	\$12,668
DER Controls	\$564	\$420	\$394	\$1,378
<i>Grand Total</i>	<i>\$79,290</i>	<i>\$51,369</i>	<i>\$47,932</i>	<i>\$178,591</i>
BESS (kW)	17,778	1,126	365	19,268
BESS (kWh)	71,111	4,503	1,459	77,074
Replacement BESS (kW)	–	17,778	19,797	37,575
Replacement BESS (kWh)	–	71,111	79,188	150,299
Var Compensation Devices (kW)	10,335	2,717	814	13,866

Table N-29. Integration Strategy 2 Annualized Cost and Volumes: Maui

Upgrade [Nominal \$000]	2016-2020	2021-2030	2031-2045	Total
Voltage Regulators	\$2,903	–	–	\$2,903
Substation Transformer	\$42,704	–	–	\$42,704
Var Compensation Devices	\$1,582	\$2,742	\$975	\$5,299
Overhead Conductor	\$5,332	\$1,901	\$348	\$7,582
Underground Conductor	\$5,114	\$102	\$71	\$5,286
DER Controls	\$564	\$420	\$394	\$1,378
<i>Grand Total</i>	<i>\$58,198</i>	<i>\$5,165</i>	<i>\$1,788</i>	<i>\$65,152</i>
Voltage Regulators (qty)	69	–	–	69
Substation Transformer (qty)	16	–	–	16
Var Compensation Devices (KW)	10,335	2,717	814	13,866
Overhead Conductor (feet)	25,244	7,786	1,211	34,242
Underground Conductor (feet)	6,236	110	61	6,407

Table N-30. Integration Strategy 3 Annualized Cost and Volumes: Maui



## N. Integrating DG-PV on Our Circuits

### Integration Strategy Cost Estimates

Upgrade [Nominal \$000]	2016-2020	2021-2030	2031-2045	Total
Voltage Regulator	\$5,966	\$1,741	\$1,969	\$9,676
Distribution Transformer	\$20,369	\$22,269	–	\$42,638
Overhead Conductor	\$5,975	\$13,178	\$16,083	\$35,236
Underground Conductor	\$2,686	\$6,171	\$11,211	\$20,068
Substation Transformer	\$35,288	\$78,174	\$24,510	\$137,972
<b>Grand Total</b>	<b>\$70,285</b>	<b>\$121,534</b>	<b>\$53,773</b>	<b>\$245,591</b>
Voltage Regulators (qty)	140	35	32	207
Distribution Transformer (qty)	1,429	1,429	–	2,858
Overhead Conductor (feet)	27,639	53,547	52,471	133,657
Underground Conductor (feet)	3,182	6,390	9,304	18,875
Substation Transformer (qty)	11	16	4	31

Table N-31. Integration Strategy 4 Annualized Cost and Volumes: Maui

Upgrade [Nominal \$000]	2016-2020	2021-2030	2031-2045	Total
Voltage Regulators	\$5,966	\$1,741	\$1,969	\$9,676
Distribution Transformer	\$20,369	\$22,269	–	\$42,638
Overhead Conductor	\$5,975	\$13,178	\$16,083	\$35,236
Underground Conductor	\$2,686	\$6,171	\$11,211	\$20,068
Substation Transformer	\$25,144	\$34,587	\$12,085	\$71,816
DER Controls	\$3,624	\$26,491	\$15,327	\$45,441
<b>Grand Total</b>	<b>\$63,764</b>	<b>\$104,438</b>	<b>\$56,675</b>	<b>\$224,876</b>
Voltage Regulators (qty)	140	35	32	207
Distribution Transformer (qty)	1,429	1,429	–	2,858
Overhead Conductor (feet)	27,639	53,547	52,471	133,657
Underground Conductor (feet)	3,182	6,390	9,304	18,875
Substation Transformer (qty)	8	8	3	19

Table N-32. Integration Strategy 5 Annualized Cost and Volumes: Maui

## N. Integrating DG-PV on Our Circuits

Integration Strategy Cost Estimates

Upgrade [Nominal \$000]	2016-2020	2021-2030	2031-2045	Total
BESS	\$168,736	\$216,615	\$129,169	\$514,520
Replacement BESS	–	\$111,087	\$443,313	\$554,401
Var Compensation Devices	\$6,460	\$8,913	\$4,857	\$20,230
DER Controls	\$3,624	\$26,491	\$15,327	\$45,441
<b>Grand Total</b>	<b>\$178,820</b>	<b>\$363,106</b>	<b>\$592,667</b>	<b>\$1,134,592</b>
BESS (kW)	43,825	82,679	55,747	182,252
BESS (kWh)	175,301	330,718	222,989	729,008
Replacement BESS (kW)	–	43,825	192,843	236,668
Replacement BESS (kWh)	–	175,301	771,371	946,672
Var Compensation Devices (kW)	7,362	8,864	3,936	20,163

Table N-33. Integration Strategy 6 Annualized Cost and Volumes: Maui

Upgrade [Nominal \$000]	2016-2020	2021-2030	2031-2045	Total
Voltage Regulators	\$3,449	–	–	\$3,449
Substation Transformer	\$35,288	–	–	\$35,288
Var Compensation Devices	\$2,519	\$8,913	\$4,857	\$16,289
BESS	\$4,210	\$51,868	\$67,688	\$123,765
Replacement BESS	–	\$2,932	\$90,443	\$93,374
Overhead Conductors	\$5,975	\$13,178	\$16,083	\$35,236
Underground Conductors	\$2,686	\$6,171	\$11,211	\$20,068
DER Controls	\$3,624	\$26,491	\$15,327	\$45,441
<b>Grand Total</b>	<b>\$57,750</b>	<b>\$109,552</b>	<b>\$205,608</b>	<b>\$372,910</b>
Voltage Regulators (qty)	82	–	–	82
Substation Transformer (qty)	11	–	–	11
Var Compensation Devices (kW)	7,362	8,864	3,936	20,163
BESS (kW)	1,173	20,234	29,261	50,668
BESS (kWh)	4,693	80,935	117,046	202,673
Replacement BESS (kW)	–	1,173	39,553	40,727
Replacement BESS (kWh)	–	4,693	158,214	162,907
Overhead Conductor (feet)	27,639	53,547	52,471	133,657
Underground Conductor (feet)	3,182	6,390	9,304	18,875

Table N-34. Integration Strategy 7 Annualized Cost and Volumes: Maui

## N. Integrating DG-PV on Our Circuits

### Integration Strategy Cost Estimates

Upgrade [Nominal \$000]	2016-2020	2021-2030	2031-2045	Total
Voltage Regulator	\$636	–	–	\$636
Distribution Transformer	\$328	\$358	–	\$686
Overhead Conductor	–	–	–	–
Underground Conductor	–	–	–	–
Substation Transformer	–	–	–	–
<b>Grand Total</b>	<b>\$964</b>	<b>\$358</b>	<b>–</b>	<b>\$1,323</b>
Voltage Regulators (qty)	15	–	–	15
Distribution Transformer (qty)	25	25	–	50
Overhead Conductor (feet)	–	–	–	–
Underground Conductor (feet)	–	–	–	–
Substation Transformer (qty)	–	–	–	–

Table N-35. Integration Strategy 1 Annualized Cost and Volumes: Moloka'i

Upgrade [Nominal \$000]	2016-2020	2021-2030	2031-2045	Total
BESS	\$3,883	\$58	\$98	\$4,039
Replacement BESS	–	\$2,499	\$2,370	\$4,868
Var Compensation Devices	\$368	\$65	\$30	\$464
DER Controls	\$16	\$5	\$11	\$33
<b>Grand Total</b>	<b>\$4,268</b>	<b>\$2,627</b>	<b>\$2,509</b>	<b>\$9,404</b>
BESS (kW)	980	21	43	1,044
BESS (kWh)	3,920	85	171	4,175
Replacement BESS (kW)	–	980	1,025	2,005
Replacement BESS (kWh)	–	3,920	4,101	8,021
Var Compensation Devices (kW)	424	68	24	515

Table N-36. Integration Strategy 2 Annualized Cost and Volumes: Moloka'i

Upgrade [Nominal \$000]	2016-2020	2021-2030	2031-2045	Total
Voltage Regulator	\$420	–	–	\$420
Var Compensation Devices	\$75	\$65	\$30	\$170
DER Controls	\$16	\$5	\$11	\$33
<b>Grand Total</b>	<b>\$511</b>	<b>\$71</b>	<b>\$41</b>	<b>\$623</b>
Voltage Regulators (qty)	10	–	–	10
Var Compensation Devices (kW)	424	68	24	515

Table N-37. Integration Strategy 3 Annualized Cost and Volumes: Moloka'i

## N. Integrating DG-PV on Our Circuits

Integration Strategy Cost Estimates

Upgrade [Nominal \$000]	2016-2020	2021-2030	2031-2045	Total
Voltage Regulators	\$636	–	–	\$636
Distribution Transformer	\$2,093	\$2,451	–	\$4,544
Overhead Conductor	–	–	–	–
Underground Conductor	–	–	–	–
Substation Transformer	–	–	–	–
<b>Grand Total</b>	<b>\$2,729</b>	<b>\$2,451</b>	<b>–</b>	<b>\$5,181</b>
Voltage Regulators (qty)	15	–	–	15
Distribution Transformer (qty)	103	103	–	206
Overhead Conductor (feet)	–	–	–	–
Underground Conductor (feet)	–	–	–	–
Substation Transformer (qty)	–	–	–	–

Table N-38. Integration Strategy 4 Annualized Cost and Volumes: Moloka'i

Upgrade [Nominal \$000]	2016-2020	2021-2030	2031-2045	Total
Voltage Regulators	\$636	–	–	\$636
Distribution Transformer	\$2,093	\$2,451	–	\$4,544
Overhead Conductor	–	–	–	–
Underground Conductor	–	–	–	–
Substation Transformer	–	–	–	–
DER Controls	\$100	\$199	\$245	\$545
<b>Grand Total</b>	<b>\$2,830</b>	<b>\$2,650</b>	<b>\$245</b>	<b>\$5,725</b>
Voltage Regulators (qty)	15	–	–	–
Distribution Transformer (qty)	103	103	–	206
Overhead Conductor (feet)	–	–	–	–
Underground Conductor (feet)	–	–	–	–
Substation Transformer (qty)	–	–	–	–

Table N-39. Integration Strategy 5 Annualized Cost and Volumes: Moloka'i

## N. Integrating DG-PV on Our Circuits

### Integration Strategy Cost Estimates

Upgrade [Nominal \$000]	2016-2020	2021-2030	2031-2045	Total
BESS	\$5,994	\$1,677	\$2,080	\$9,750
Replacement BESS	–	\$3,954	\$6,550	\$10,504
Var Compensation Devices	\$334	\$110	\$77	\$521
DER Controls	\$100	\$199	\$245	\$545
<b>Grand Total</b>	<b>\$6,428</b>	<b>\$5,941</b>	<b>\$8,951</b>	<b>\$21,320</b>
BESS (kW)	1,561	641	900	3,101
BESS (kWh)	6,242	2,562	3,599	12,403
Replacement BESS (kW)	–	1,561	2,848	4,408
Replacement BESS (kWh)	–	6,242	11,390	17,632
Var Compensation Devices (kW)	377	114	61	553

Table N-40. Integration Strategy 6 Annualized Cost and Volumes: Moloka'i

Upgrade [Nominal \$000]	2016-2020	2021-2030	2031-2045	Total
Voltage Regulators	\$420	–	–	\$420
Var Compensation Devices	\$199	\$110	\$77	\$386
BESS	–	–	–	–
Replacement BESS	–	–	–	–
DER Controls	\$100	\$199	\$245	\$545
<b>Grand Total</b>	<b>\$720</b>	<b>\$309</b>	<b>\$322</b>	<b>\$1,351</b>
Voltage Regulators (qty)	10	–	–	10
Var Compensation Devices (kW)	377	114	61	553
BESS (kW)	–	–	–	–
BESS (kWh)	–	–	–	–
Replacement BESS (kW)	–	–	–	–
Replacement BESS (kWh)	–	–	–	–

Table N-41. Integration Strategy 7 Annualized Cost and Volumes: Moloka'i

## N. Integrating DG-PV on Our Circuits

### Integration Strategy Cost Estimates

Upgrade [Nominal \$000]	2016-2020	2021-2030	2031-2045	Total
Voltage Regulators	\$255	–	–	\$255
Distribution Transformer	\$114	\$125	–	\$239
Overhead Conductor	–	–	–	–
Underground Conductor	–	–	–	–
Substation Transformer	–	–	–	–
<b>Grand Total</b>	<b>\$369</b>	<b>\$125</b>	<b>–</b>	<b>\$493</b>
Voltage Regulators (qty)	6	–	–	6
Distribution Transformer (qty)	10	10	–	20
Overhead Conductor (feet)	–	–	–	–
Underground Conductor (feet)	–	–	–	–
Substation Transformer (qty)	–	–	–	–

Table N-42. Integration Strategy 1 Annualized Cost and Volumes: Lana'i

Upgrade [Nominal \$000]	2016-2020	2021-2030	2031-2045	Total
BESS	\$3,954	\$275	\$815	\$5,043
Replacement BESS	–	\$2,569	\$2,868	\$5,438
Var Compensation Devices	\$107	\$133	\$250	\$490
DER Controls	\$28	\$26	\$89	\$143
<b>Grand Total</b>	<b>\$4,089</b>	<b>\$3,003</b>	<b>\$4,022</b>	<b>\$11,114</b>
BESS (kW)	1,010	104	355	1,470
BESS (kWh)	4,042	418	1,422	5,881
Replacement BESS (kW)	–	1,010	1,244	2,255
Replacement BESS (kWh)	–	4,042	4,976	9,018
Var Compensation Devices (kW)	123	131	197	451

Table N-43. Integration Strategy 2 Annualized Cost and Volumes: Lana'i

Upgrade [Nominal \$000]	2016-2020	2021-2030	2031-2045	Total
Voltage Regulators	\$168	–	–	\$168
Var Compensation Devices	\$36	\$133	\$250	\$419
DER Controls	\$28	\$26	\$89	\$143
<b>Grand Total</b>	<b>\$232</b>	<b>\$159</b>	<b>\$339</b>	<b>\$730</b>
Voltage Regulators (qty)	4	–	–	4
Var Compensation Devices (kW)	123	131	197	451

Table N-44. Integration Strategy 3 Annualized Cost and Volumes: Lana'i

## N. Integrating DG-PV on Our Circuits

### Integration Strategy Cost Estimates

Upgrade [Nominal \$000]	2016-2020	2021-2030	2031-2045	Total
Voltage Regulators	\$255	\$158	–	\$412
Distribution Transformer	\$742	\$869	–	\$1,610
Overhead Conductor	–	–	–	–
Underground Conductor	–	–	–	–
Substation Transformer	–	–	–	–
<b>Grand Total</b>	<b>\$996</b>	<b>\$1,026</b>	<b>–</b>	<b>\$2,023</b>
Voltage Regulators (qty)	6	3	–	9
Distribution Transformer (qty)	37	37	–	73
Overhead Conductor (feet)	–	–	–	–
Underground Conductor (feet)	–	–	–	–
Substation Transformer (qty)	–	–	–	–

Table N-45. Integration Strategy 4 Annualized Cost and Volumes: Lana'i

Upgrade [Nominal \$000]	2016-2020	2021-2030	2031-2045	Total
Voltage Regulators	\$255	\$158	–	\$412
Distribution Transformer	\$742	\$869	–	\$1,610
Overhead Conductor	–	–	–	–
Underground Conductor	–	–	–	–
Substation Transformer	–	–	–	–
DER Controls	\$73	\$849	\$133	\$1,055
<b>Grand Total</b>	<b>\$1,069</b>	<b>\$1,875</b>	<b>\$133</b>	<b>\$3,077</b>
Voltage Regulators (qty)	6	3	–	9
Distribution Transformer (qty)	37	37	–	73
Overhead Conductor (feet)	–	–	–	–
Underground Conductor (feet)	–	–	–	–
Substation Transformer (qty)	–	–	–	–

Table N-46. Integration Strategy 5 Annualized Cost and Volumes: Lana'i

## N. Integrating DG-PV on Our Circuits

### Integration Strategy Cost Estimates

Upgrade [Nominal \$000]	2016–2020	2021–2030	2031–2045	Total
BESS	\$1,262	\$4,962	\$1,268	\$7,492
Replacement BESS	–	\$850	\$8,062	\$8,911
Var Compensation Devices	\$17	\$143	\$17	\$177
DER Controls	\$73	\$849	\$133	\$1,055
<i>Grand Total</i>	<i>\$1,352</i>	<i>\$6,804</i>	<i>\$9,479</i>	<i>\$17,635</i>
BESS (kW)	337	1,923	532	2,791
BESS (kWh)	1,348	7,690	2,127	11,165
Replacement BESS (kW)	–	337	3,512	3,849
Replacement BESS (kWh)	–	1,348	14,049	15,396
Var Compensation Devices (kW)	19	137	15	171

Table N-47. Integration Strategy 6 Annualized Cost and Volumes: Lana'i

Upgrade [Nominal \$000]	2016–2020	2021–2030	2031–2045	Total
Voltage Regulators	\$168	\$158	–	\$326
Var Compensation Devices	\$10	\$143	\$17	\$170
BESS	–	–	–	–
Replacement BESS	–	–	–	–
DER Controls	\$73	\$849	\$133	\$1,055
<i>Grand Total</i>	<i>\$251</i>	<i>\$1,149</i>	<i>\$150</i>	<i>\$1,551</i>
Voltage Regulators (qty)	4	–	–	4
Var Compensation Devices (kW)	19	137	15	171
BESS (kW)	–	–	–	–
BESS (kWh)	–	–	–	–
Replacement BESS (kW)	–	–	–	–
Replacement BESS (kWh)	–	–	–	–

Table N-48. Integration Strategy 7 Annualized Cost and Volumes: Lana'i



## N. Integrating DG-PV on Our Circuits

### Integration Strategy Cost Estimates

Upgrade [Nominal \$000]	2016-2020	2021-2030	2031-2045	Total
Voltage Regulators	\$5,054	\$7,527	\$5,375	\$17,956
Distribution Transformer	\$3,908	\$1,792	\$1,413	\$7,113
Overhead Conductor	–	–	–	–
Underground Conductor	–	–	–	–
Substation Transformer	–	–	–	–
<b>Grand Total</b>	<b>\$8,963</b>	<b>\$9,320</b>	<b>\$6,787</b>	<b>\$25,069</b>
Voltage Regulators (qty)	72	94	54	220
Distribution Transformer (qty)	318	126	85	529
Overhead Conductor (feet)	–	–	–	–
Underground Conductor (feet)	–	–	–	–
Substation Transformer (qty)	–	–	–	–

Table N-49. Integration Strategy 1 Annualized Cost and Volumes: Hawai'i Island

Upgrade [Nominal \$000]	2016-2020	2021-2030	2031-2045	Total
BESS	\$32,177	\$9,048	\$6,975	\$48,200
Replacement BESS	–	\$21,656	\$11,781	\$33,437
Var Compensation Devices	\$57	–	\$258	\$315
DER Controls	\$2,589	\$4,694	\$11,144	\$18,426
<b>Grand Total</b>	<b>\$34,822</b>	<b>\$35,398</b>	<b>\$30,158</b>	<b>\$100,378</b>
BESS (kW)	8,586	3,439	2,991	15,016
BESS (kWh)	34,344	13,756	11,964	60,064
Replacement BESS (kW)	–	8,586	5,105	–
Replacement BESS (kWh)	–	34,344	20,420	54,764
Var Compensation Devices (kW)	63	–	230	293

Table N-50. Integration Strategy 2 Annualized Cost and Volumes: Hawai'i Island

Upgrade [Nominal \$000]	2016-2020	2021-2030	2031-2045	Total
Voltage Regulators	\$3,472	–	–	\$3,472
Var Compensation Devices	\$57	–	\$258	\$315
DER Controls	\$2,589	\$4,694	\$11,144	\$18,426
<b>Grand Total</b>	<b>\$6,117</b>	<b>\$4,694</b>	<b>\$11,402</b>	<b>\$22,213</b>
Voltage Regulators (qty)	50	–	–	50
Var Compensation Devices (kW)	63	–	230	293

Table N-51. Integration Strategy 3 Annualized Cost and Volumes: Hawai'i Island

## N. Integrating DG-PV on Our Circuits

Integration Strategy Cost Estimates

Upgrade [Nominal \$000]	2016-2020	2021-2030	2031-2045	Total
Voltage Regulators	\$14,327	\$2,107	\$760	\$17,194
Distribution Transformer	\$1,397	\$2,737	\$161	\$4,295
Overhead Conductor	\$1,803	\$1,492	–	\$3,295
Underground Conductor	–	–	–	–
Substation Transformer	\$4,109	\$38,258	\$51,456	\$93,823
<b>Grand Total</b>	<b>\$21,635</b>	<b>\$44,594</b>	<b>\$52,377</b>	<b>\$118,607</b>
Voltage Regulators (qty)	191	25	8	224
Distribution Transformer (qty)	115	195	10	320
Overhead Conductor (feet)	24,159	17,652	–	41,811
Underground Conductor (feet)	–	–	–	–
Substation Transformer (qty)	4	26	31	61

Table N-52. Integration Strategy 4 Annualized Cost and Volumes: Hawai'i Island

Upgrade [Nominal \$000]	2016-2020	2021-2030	2031-2045	Total
Voltage Regulators	\$14,327	\$2,107	\$760	\$17,194
Distribution Transformer	\$1,397	\$2,737	\$161	\$4,295
Overhead Conductor	\$1,803	\$1,492	–	\$3,295
Underground Conductor	–	–	–	–
Substation Transformer	–	\$8,794	\$21,176	\$29,970
DER Controls	\$4,364	\$40,012	\$29,229	\$73,604
<b>Grand Total</b>	<b>\$21,890</b>	<b>\$55,142</b>	<b>\$51,326</b>	<b>\$128,358</b>
Voltage Regulators (qty)	191	25	8	224
Distribution Transformer (qty)	115	195	10	320
Overhead Conductor (feet)	24,159	17,652	–	41,811
Underground Conductor (feet)	–	–	–	–
Substation Transformer (qty)	–	6	14	20

Table N-53. Integration Strategy 5 Annualized Cost and Volumes: Hawai'i Island

## N. Integrating DG-PV on Our Circuits

### Integration Strategy Cost Estimates

Upgrade [Nominal \$000]	2016-2020	2021-2030	2031-2045	Total
BESS	\$33,076	\$187,013	\$178,911	\$398,999
Replacement BESS	–	\$23,280	\$254,356	\$277,636
Var Compensation Devices	\$1,130	\$94	–	\$1,224
DER Controls	\$4,364	\$40,012	\$29,229	\$73,604
<b>Grand Total</b>	<b>\$38,570</b>	<b>\$250,398</b>	<b>\$462,495</b>	<b>\$751,463</b>
BESS (kW)	9,334	72,449	76,950	158,733
BESS (kWh)	37,336	289,796	307,800	634,932
Replacement BESS (kW)	–	9,334	110,713	120,047
Replacement BESS (kWh)	–	37,336	442,852	480,188
Var Compensation Devices (kW)	1,276	93	–	1,370

Table N-54. Integration Strategy 6 Annualized Cost and Volumes: Hawai'i Island

Upgrade [Nominal \$000]	2016-2020	2021-2030	2031-2045	Total
Voltage Regulators	\$12,675	–	–	\$12,675
Substation Transformer	\$4,109	–	–	\$4,109
Var Compensation Devices	\$742	\$94	–	\$836
BESS	–	\$24,735	\$46,802	\$71,537
Replacement BESS	–	–	\$41,189	\$41,189
Overhead Conductor	\$1,803	\$1,492	–	\$3,295
DER Controls	\$4,364	\$40,012	\$29,229	\$73,604
<b>Grand Total</b>	<b>\$23,692</b>	<b>\$66,334</b>	<b>\$117,219</b>	<b>\$207,244</b>
Voltage Regulators (qty)	168	–	–	168
Substation Transformer (qty)	4	–	–	4
Var Compensation Devices (kW)	1,276	93	–	1,370
BESS (kW)	–	9,732	20,318	30,050
BESS (kWh)	–	38,928	81,272	120,200
Replacement BESS (kW)	–	–	18,030	18,030
Replacement BESS (kWh)	–	–	72,120	72,120
Overhead Conductor (feet)	24,159	17,652	–	41,811

Table N-55. Integration Strategy 7 Annualized Cost and Volume: Hawai'i Island